

Connector - SACC-M 8FR-3CON-M-SW - 1407582

Please be informed that the data shown in this PDF Document is generated from our Online Catalog. Please find the complete data in the user's documentation. Our General Terms of Use for Downloads are valid (<http://phoenixcontact.com/download>)



Connector, Universal, 3-position, Socket angled M8, A-coded, Screw connection, knurl material: Nickel-plated brass, external cable diameter 3.5 mm ... 5 mm

Your advantages

- Safe use in the field, thanks to a high degree of protection
- Flexible: connectors for on-site assembly
- Screw connection: proven connection technology for a large selection of different conductors



Key Commercial Data

Packing unit	1 pc
GTIN	 4 046356 780025
GTIN	4046356780025
Weight per Piece (excluding packing)	10.170 g
Custom tariff number	85366990
Country of origin	Germany

Technical data

Dimensions

Diameter housing	13 mm
Length	42 mm
External cable diameter	3.5 mm ... 5 mm
Stripping length of the sheath	12 mm
Stripping length of the individual wire	4 mm

Ambient conditions

Ambient temperature (operation)	-40 °C ... 85 °C (Plug / socket)
Degree of protection	IP67

General

Connector - SACC-M 8FR-3CON-M-SW - 1407582

Technical data

General

Note	NOTE: Observe the permissible bending radii when laying conductors, since the degree of protection may be put in jeopardy if the bending forces are too high. Alleviate mechanical loads upstream of the connector, e.g. by using cable ties.
Rated current at 40°C	4 A
Rated voltage	48 V AC
	60 V DC
Number of positions	3
Insulation resistance	≥ 100 MΩ
Coding	A - standard
Standards/regulations	M8 connector IEC 61076-2-104
Signal type/category	Universal
Status display	No
Overvoltage category	III
Degree of pollution	3
Connection method	Screw connection
Conductor cross section	0.14 mm ² ... 0.5 mm ² (without ferrule)
	0.14 mm ² ... 0.5 mm ² (with ferrule)
	0.14 mm ² ... 0.5 mm ² (solid)
Conductor cross section AWG	26 ... 20 (without ferrule)
Insertion/withdrawal cycles	≥ 100
Torque	0.2 Nm (M8 knurl)
	0.5 Nm (Connector with coupling sleeve)
	0.3 Nm ... 0.4 Nm (Pressure screw for outer cable diameter 3 mm ... 4 mm)
	0.8 Nm ... 1 Nm (Pressure screw in the case of external cable diameter 4 mm ... 5 mm)
	0.1 Nm (Screw terminal blocks)
Assembly instructions	The wires can be connected both with ferrules (without insulation) and without ferrules.
	The connector pin assignment can be rotated 180° to the cable outlet

Material

Flammability rating according to UL 94	HB
Contact material	CuZn
Contact surface material	Au
Contact carrier material	PA
Material of grip body	PBT
Material, knurls	Nickel-plated brass
Sealing material	NBR

Standards and Regulations

Standard designation	M8 connector
Standards/regulations	IEC 61076-2-104

Connector - SACC-M 8FR-3CON-M-SW - 1407582

Technical data

Standards and Regulations

Flammability rating according to UL 94	HB
--	----

Environmental Product Compliance

	Lead 7439-92-1
China RoHS	Environmentally Friendly Use Period = 50
	For details about hazardous substances go to tab "Downloads", Category "Manufacturer's declaration"

Drawings

Dimensional drawing

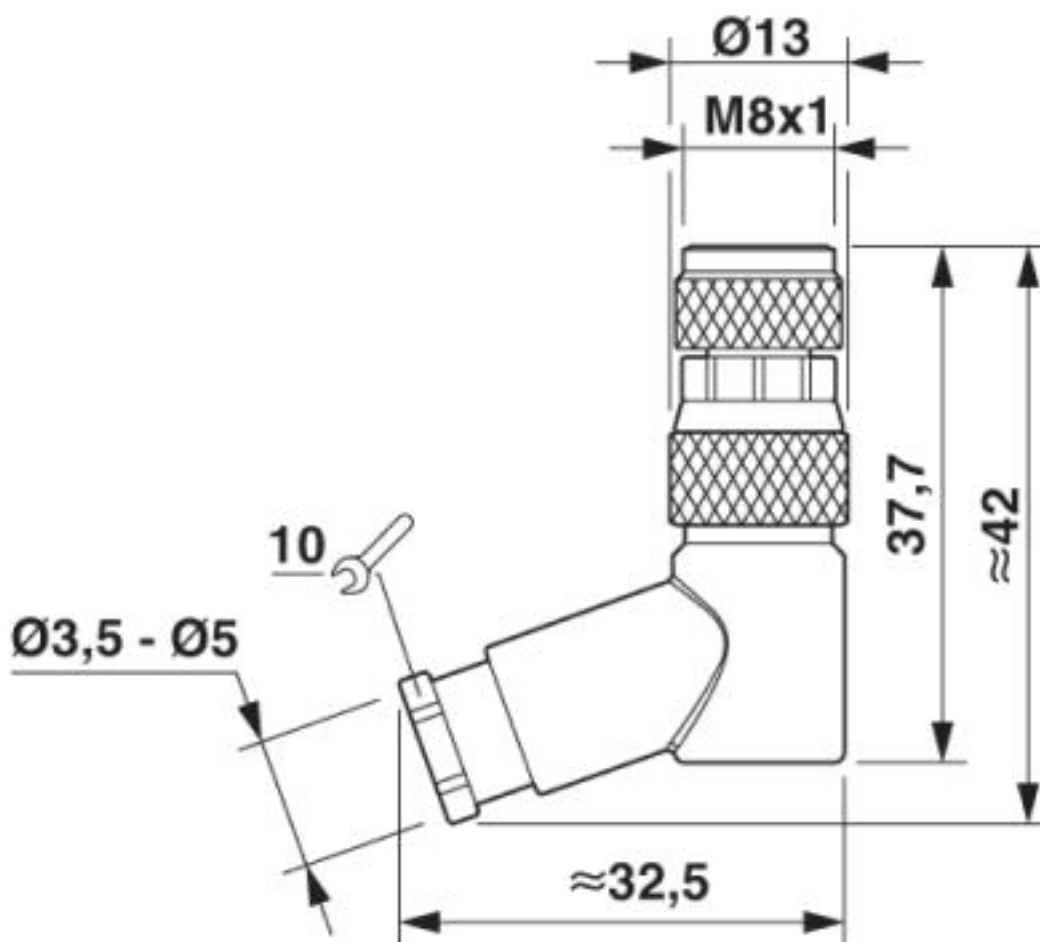

Socket M8 x 1, angled

Connector - SACC-M 8FR-3CON-M-SW - 1407582

Schematic diagram

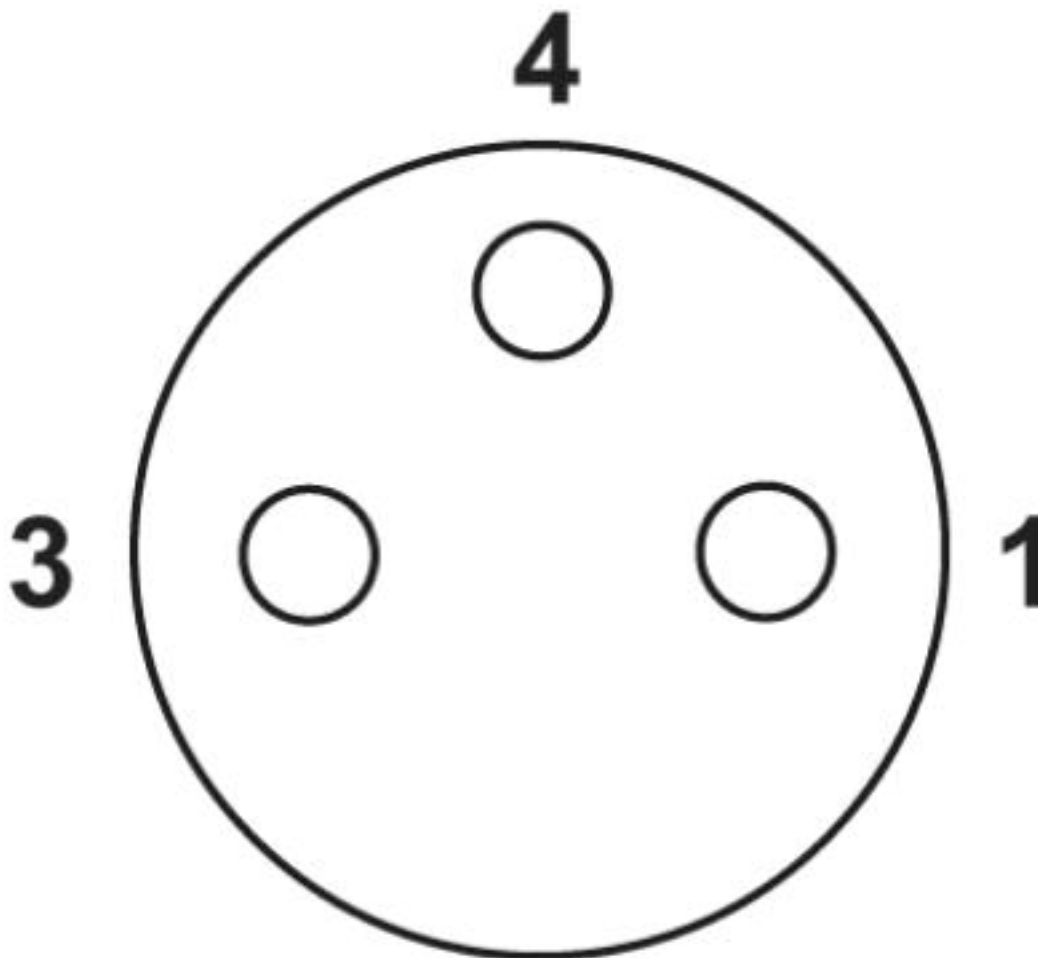

Pin assignment M8 socket, 3-pos., view female side

Classifications

eCl@ss

eCl@ss 4.0	27260700
eCl@ss 4.1	27260700
eCl@ss 5.0	27260700
eCl@ss 5.1	27260700
eCl@ss 6.0	27279200
eCl@ss 7.0	27440104
eCl@ss 8.0	27440104
eCl@ss 9.0	27440102

ETIM

ETIM 3.0	EC000754
----------	----------

<https://www.phoenixcontact.com/gb/products/1407582>



Connector - SACC-M 8FR-3CON-M-SW - 1407582

Classifications

ETIM

ETIM 4.0	EC002062
ETIM 5.0	EC002062
ETIM 6.0	EC002062

UNSPSC

UNSPSC 6.01	31261501
UNSPSC 7.0901	31261501
UNSPSC 11	31261501
UNSPSC 12.01	31261501
UNSPSC 13.2	39121413

Approvals

Approvals

Approvals

UL Listed / cUL Listed / EAC / EAC / cULus Listed

Ex Approvals

Approval details

UL Listed		http://database.ul.com/cgi-bin/XYV/template/LISEXT/1FRAME/index.htm	FILE E 221474
Nominal voltage UN		60 V	
Nominal current IN		4 A	

cUL Listed		http://database.ul.com/cgi-bin/XYV/template/LISEXT/1FRAME/index.htm	FILE E 221474
Nominal voltage UN		60 V	
Nominal current IN		4 A	

EAC		RU C- DE.AI30.B.01102
-----	---	--------------------------

<https://www.phoenixcontact.com/gb/products/1407582>



Connector - SACC-M 8FR-3CON-M-SW - 1407582

Approvals

EAC		EAC-Zulassung
-----	---	---------------

cULus Listed	
--------------	---

Phoenix Contact 2019 © - all rights reserved
<http://www.phoenixcontact.com>



SCATTERGOOD & JOHNSON LTD

ELECTRICAL ENGINEERING & FLUID CONTROL DISTRIBUTORS

Est.1899

At Scattergood & Johnson Ltd, we pride ourselves on being a technical distributor to specialist industries.

Working with a range of quality product suppliers across a number of specialist markets, we are not your average 'box shifter' - we are your technical and supply chain partner.

We fully support every product we sell - for free! Our internal team and external sales engineers can answer any product or application question, no matter the complexity.

Backing up this technical ability is a range of 50,000+ products available from stock for nationwide next day delivery (same day if required!), or you can collect what you need from any of our trade counters around the UK.

Select your specialist interest below to learn more about how we can help.

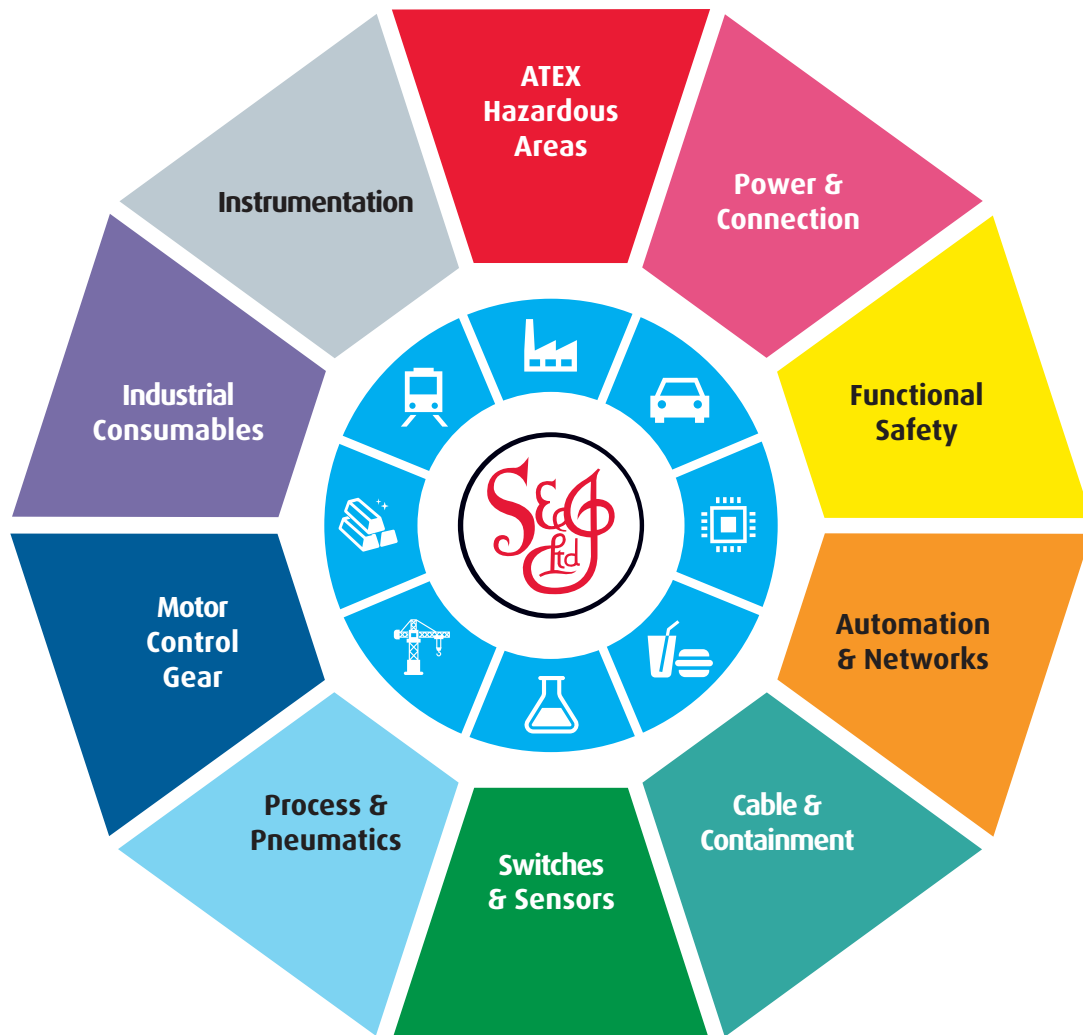

Online, In Branch and On the Road - Scattergood & Johnson Ltd, there when you need us.

www.scatts.co.uk