

Contact insert - HC-HS06-I-UT-F - 1406530

Please be informed that the data shown in this PDF Document is generated from our Online Catalog. Please find the complete data in the user's documentation. Our General Terms of Use for Downloads are valid (<http://phoenixcontact.com/download>)



HEAVYCON female insert, HS6 series, 6-pos., screw connection

Your advantages

- For fast coding with plastic profile



Key Commercial Data

Packing unit	1 pc
GTIN	 4 046356 921350
GTIN	4046356921350
Weight per Piece (excluding packing)	94.900 g
Custom tariff number	85366990
Country of origin	China

Technical data

General

Note	For HEAVYCON housing B16 and B32
Connection method	Screw connection
Tightening torque	1.2 Nm
Number of connections per position	1
Degree of pollution	3
Overvoltage category	III
Number of positions	6+PE
Insertion/withdrawal cycles	≥ 500
Size	B16
Contact numbering	1 - 6
Conductor cross section	0.5 mm ² ... 6 mm ² (power contacts)
Connection cross section AWG	20 ... 10

Contact insert - HC-HS06-I-UT-F - 1406530

Technical data

General

Stripping length of the individual wire	10 mm
Assembly instructions	To ensure correct use, installation in housing with IP54 protection or better is required
Connection	Connectors may only be actuated when there is no load/voltage.

Ambient conditions

Ambient temperature (operation)	-40 °C ... 125 °C (including heating up of contacts)
---------------------------------	--

Material data

Contact material	Copper alloy
Contact surface material	Ag
Contact carrier material	PC
Standards/regulations	PC: Fire protection in rail vehicles - requirement sets R22, R23, and R24 acc. to DIN EN 45545-2 (Risk level HL1 - HL3)

Electrical characteristics

Rated voltage for power contacts	400/690 V
Rated voltage (III/3)	400 V (Conductor-PE)
	690 V (Conductor-Conductor)
Rated surge voltage	6 kV (power contacts)
Rated current	41 A (power contacts)

Standards and Regulations

Flammability rating according to UL 94	V0
--	----

Environmental Product Compliance

	Lead 7439-92-1
China RoHS	Environmentally Friendly Use Period = 50
	For details about hazardous substances go to tab "Downloads", Category "Manufacturer's declaration"

Drawings

Contact insert - HC-HS06-I-UT-F - 1406530

Diagram

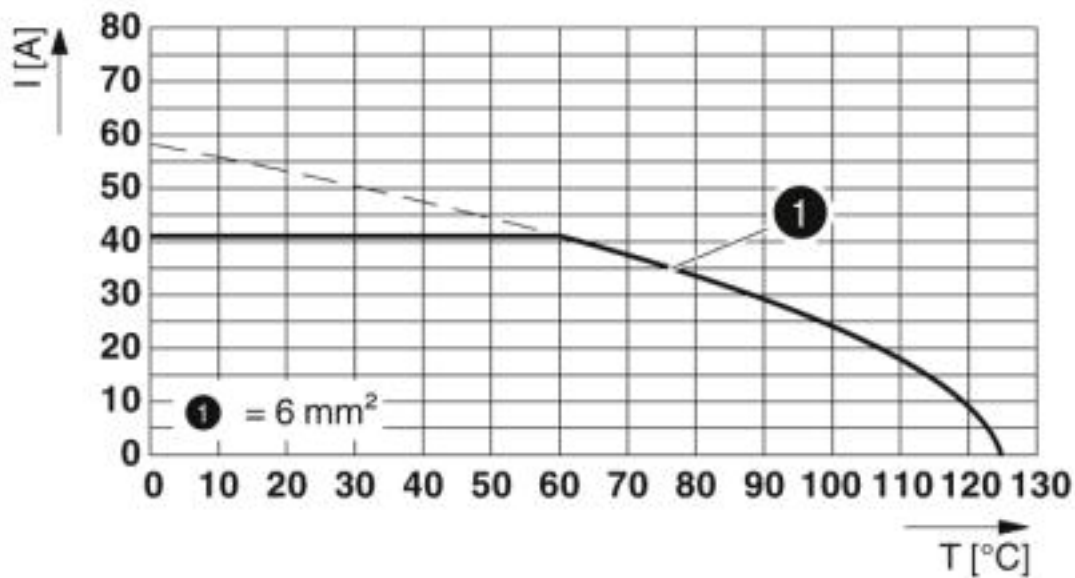

Derating diagram

Diagram

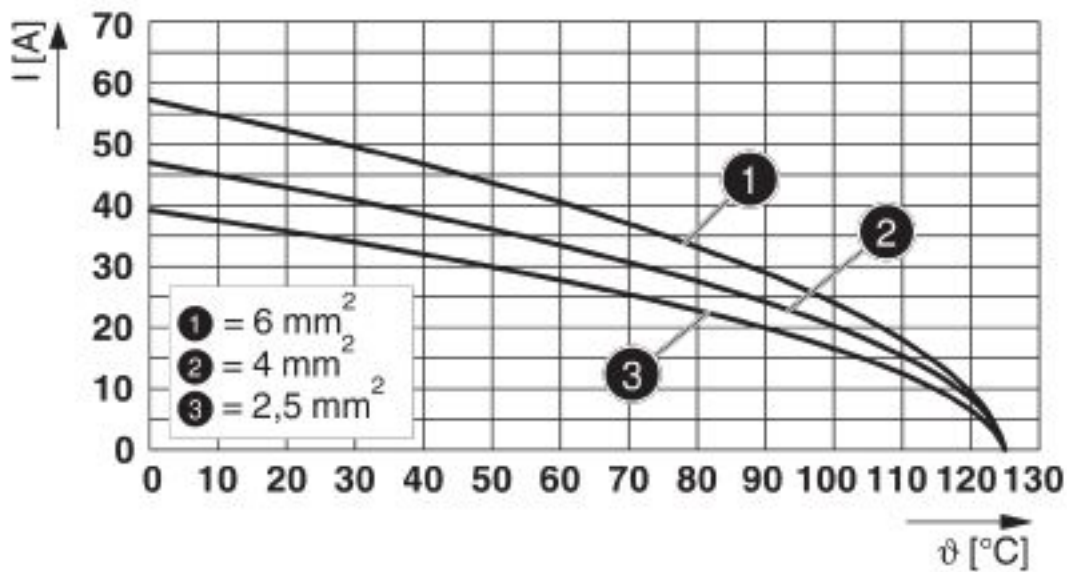

Derating diagram

Contact insert - HC-HS06-I-UT-F - 1406530

Dimensional drawing

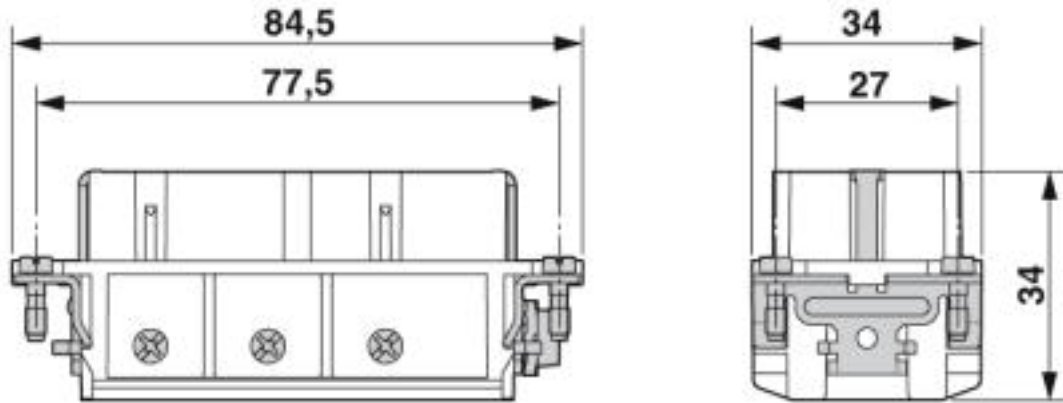

Dimensional drawing

Dimensional drawing

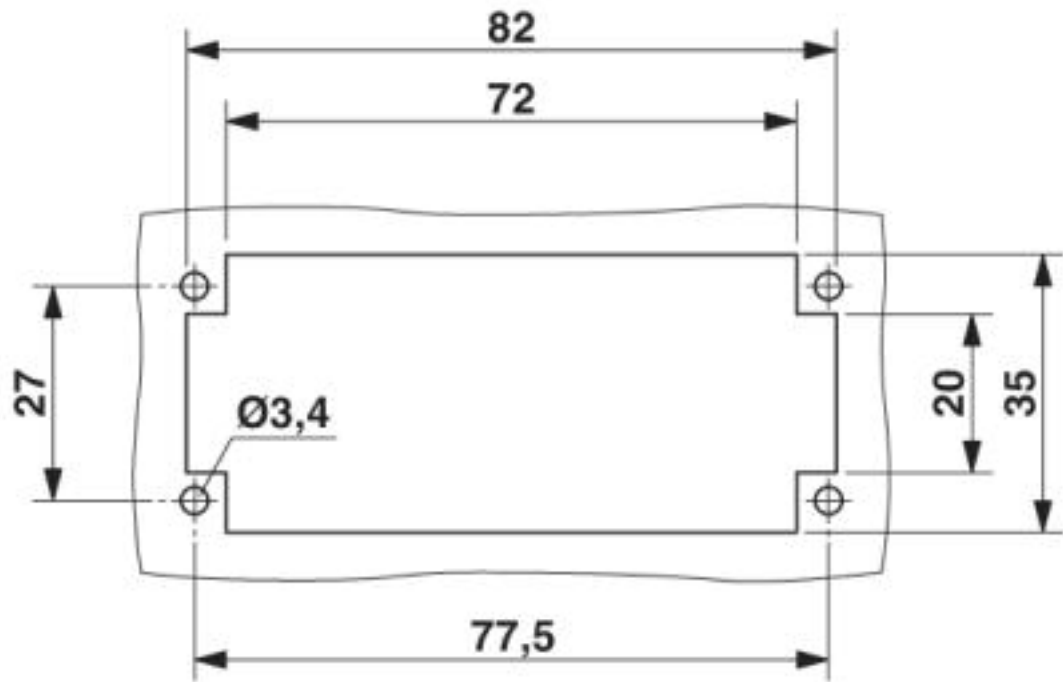

Mounting cutout when used without housing

Contact insert - HC-HS06-I-UT-F - 1406530

Schematic diagram

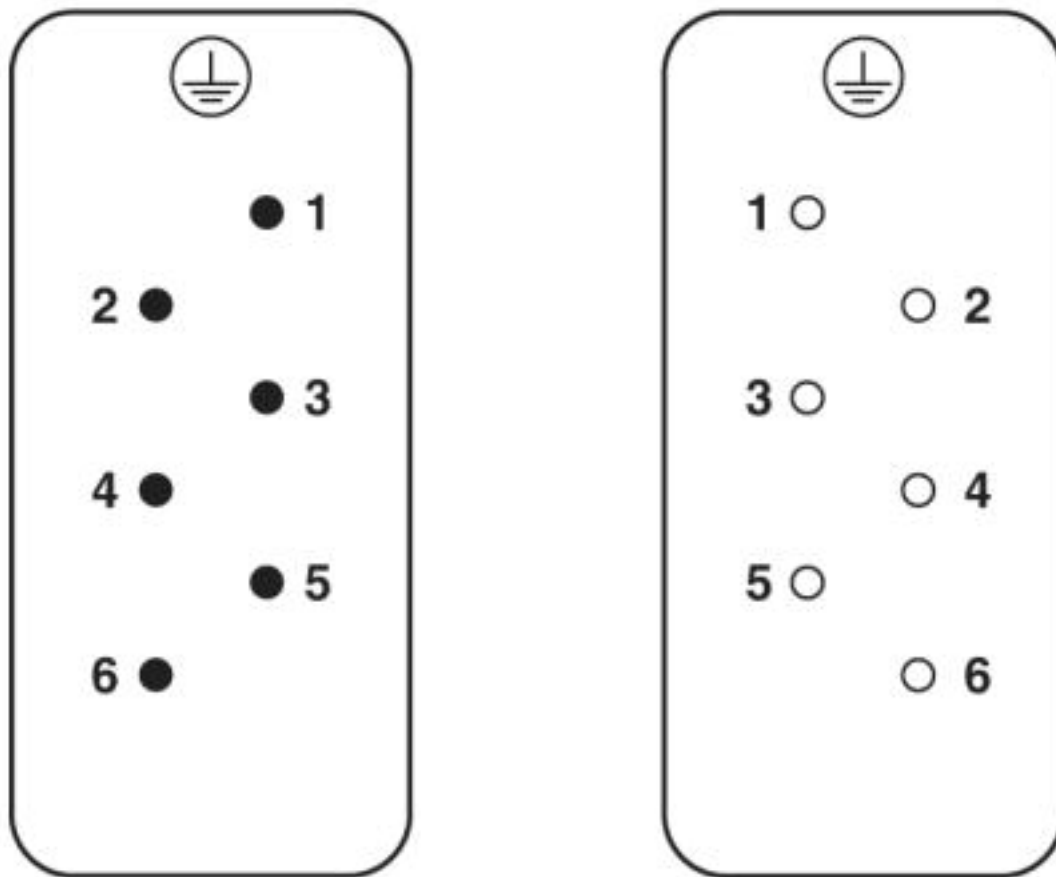

Connector pin assignment, connection side

Classifications

eCl@ss

eCl@ss 5.1	27261200
eCl@ss 6.0	27261200
eCl@ss 7.0	27440205
eCl@ss 8.0	27440205
eCl@ss 9.0	27440205

ETIM

ETIM 4.0	EC000438
ETIM 5.0	EC000438
ETIM 6.0	EC000438
ETIM 7.0	EC000438

UNSPSC

UNSPSC 13.2	39121522
-------------	----------

<https://www.phoenixcontact.com/gb/products/1406530>



Contact insert - HC-HS06-I-UT-F - 1406530

Approvals

Approvals

Approvals

CSA / UL Recognized / EAC / DNV GL

Ex Approvals

Approval details

CSA		http://www.csagroup.org/services-industries/product-listing/	013631_0_000
Nominal voltage UN		600 V	
Nominal current IN		32 A	
mm ² /AWG/kcmil		10	

UL Recognized		http://database.ul.com/cgi-bin/XYV/template/LISEXT/1FRAME/index.htm	FILE E 118976
Nominal voltage UN		600 V	
Nominal current IN		35 A	
mm ² /AWG/kcmil		10	

EAC			RU C- DE.AI30.B.01102
-----	---	--	--------------------------

DNV GL		https://approvalfinder.dnvgl.com/	TAE000037S
--------	---	---	------------

Phoenix Contact 2019 © - all rights reserved
<http://www.phoenixcontact.com>



SCATTERGOOD & JOHNSON LTD

ELECTRICAL ENGINEERING & FLUID CONTROL DISTRIBUTORS

Est.1899

At Scattergood & Johnson Ltd, we pride ourselves on being a technical distributor to specialist industries.

Working with a range of quality product suppliers across a number of specialist markets, we are not your average 'box shifter' - we are your technical and supply chain partner.

We fully support every product we sell - for free! Our internal team and external sales engineers can answer any product or application question, no matter the complexity.

Backing up this technical ability is a range of 50,000+ products available from stock for nationwide next day delivery (same day if required!), or you can collect what you need from any of our trade counters around the UK.

Select your specialist interest below to learn more about how we can help.



Online, In Branch and On the Road - Scattergood & Johnson Ltd, there when you need us.

www.scatts.co.uk