

<https://www.phoenixcontact.com/gb/products/1553213>

Connector - SACC-M12MR-5CON-PG 7-VA - 1553213

Please be informed that the data shown in this PDF Document is generated from our Online Catalog. Please find the complete data in the user's documentation. Our General Terms of Use for Downloads are valid (<http://phoenixcontact.com/download>)



Connector, 5-position, Plug angled M12, A-coded, Screw connection, knurl material: Stainless steel 1.4404, cable gland Pg7, external cable diameter 4 mm ... 6 mm

Your advantages

- Safe use in the field, thanks to a high degree of protection
- Flexible: connectors for on-site assembly
- Screw connection: proven connection technology for a large selection of different conductors

RoHS

Key Commercial Data

Packing unit	1 pc
GTIN	 4 046356 170130
GTIN	4046356170130
Weight per Piece (excluding packing)	22.300 g
Custom tariff number	85366990
Country of origin	Germany

Technical data

Dimensions

Diameter housing	20 mm
Length	44 mm
External cable diameter	4 mm ... 6 mm
Stripping length of the sheath	20 mm
Stripping length of the individual wire	5 mm

Ambient conditions

Ambient temperature (operation)	-40 °C ... 85 °C (Plug / socket)
Degree of protection	IP65
	IP67
	IP69K

10/25/2019 Page 1 / 7

Connector - SACC-M12MR-5CON-PG 7-VA - 1553213

Technical data

General

Note	NOTE: Observe the permissible bending radii when laying conductors, since the degree of protection may be put in jeopardy if the bending forces are too high. Alleviate mechanical loads upstream of the connector, e.g. by using cable ties.
Rated current at 40°C	4 A
Rated voltage	48 V AC 60 V DC
Number of positions	5
Color handle area	black
Insulation resistance	≥ 100 MΩ
Coding	A - standard
Standards/regulations	M12 connector IEC 61076-2-101
Status display	No
Overvoltage category	II
Degree of pollution	3
Connection method	Screw connection
Conductor cross section	0.25 mm ² ... 0.75 mm ² (without ferrule) 0.14 mm ² ... 0.75 mm ² (with ferrule) 0.25 mm ² ... 0.75 mm ² (solid)
Conductor cross section AWG	24 ... 18 (without ferrule) 26 ... 20 (with ferrule)
Insertion/withdrawal cycles	≥ 100
Torque	0.8 Nm ... 1 Nm (Pressure screw) 0.2 Nm (Screw terminal blocks) 0.4 Nm (M12 knurl)
Tightening torque	Screw plug insert with sleeve housing as far it will go
Assembly instructions	The wires can be connected both with ferrules and without ferrules The connector pin assignment can be rotated 90° to the cable outlet

Material

Contact material	CuZn
Contact surface material	Au
Contact carrier material	PA
Material of grip body	PA
Material, knurls	Stainless steel 1.4404
Sealing material	NBR

Standards and Regulations

Standard designation	M12 connector
Standards/regulations	IEC 61076-2-101
Connection in acc. with standard	CUL

Environmental Product Compliance

Connector - SACC-M12MR-5CON-PG 7-VA - 1553213

Technical data

Environmental Product Compliance

	Lead 7439-92-1
China RoHS	Environmentally Friendly Use Period = 50
	For details about hazardous substances go to tab "Downloads", Category "Manufacturer's declaration"

Drawings

Dimensional drawing

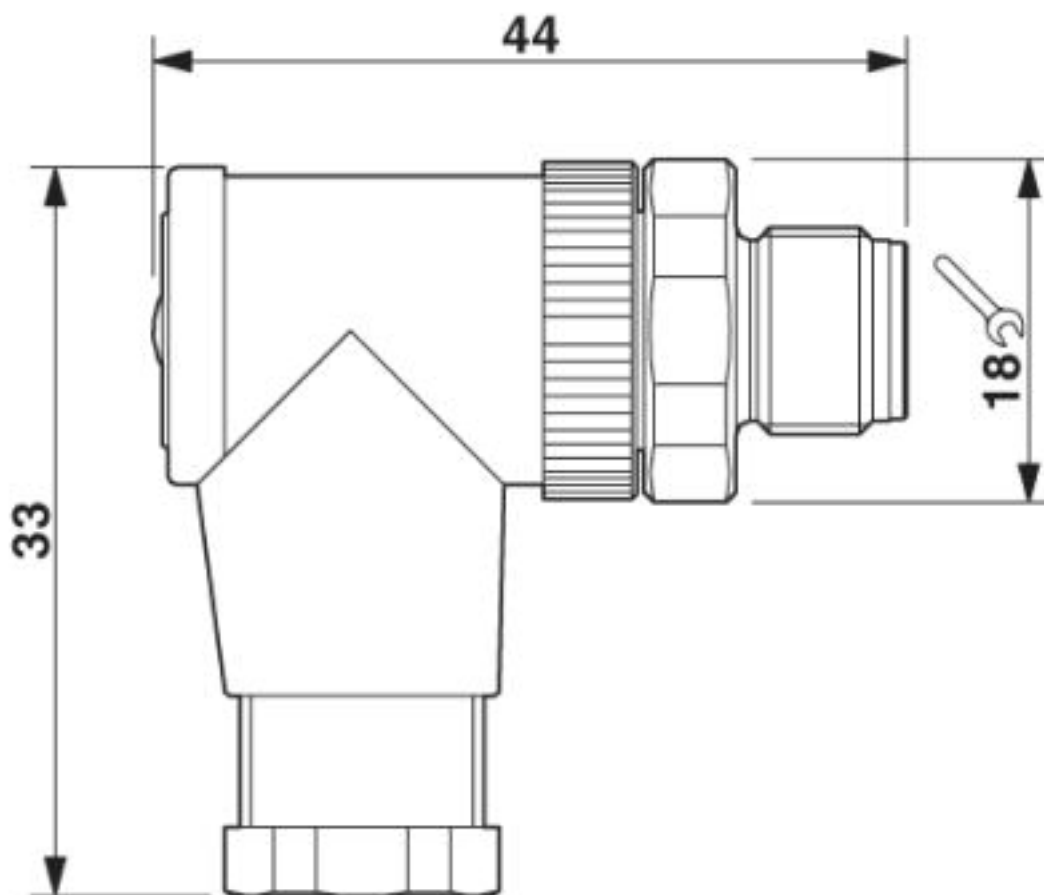

M12 x 1 male plug, angled

Connector - SACC-M12MR-5CON-PG 7-VA - 1553213

Schematic diagram

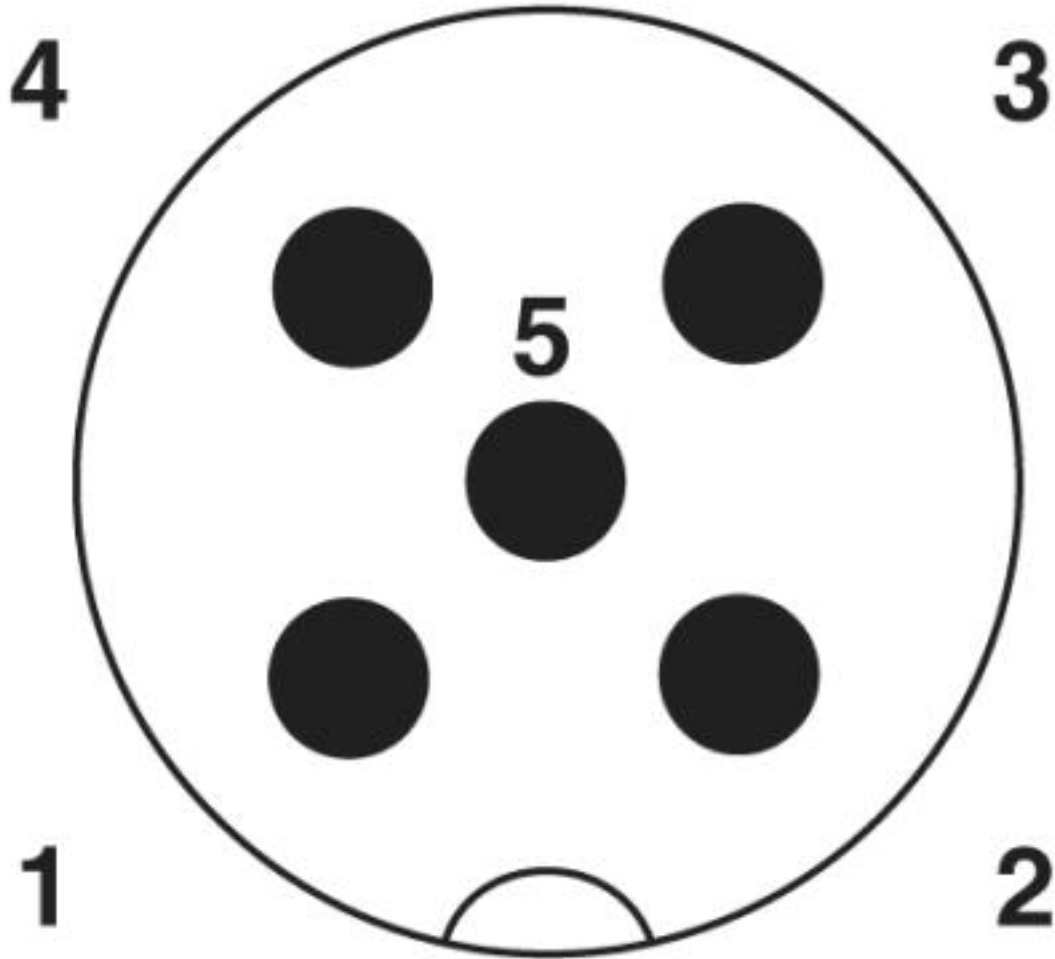

Pin assignment M12 male connector, 5-pos., A-coded, male side

Connector - SACC-M12MR-5CON-PG 7-VA - 1553213

Schematic diagram

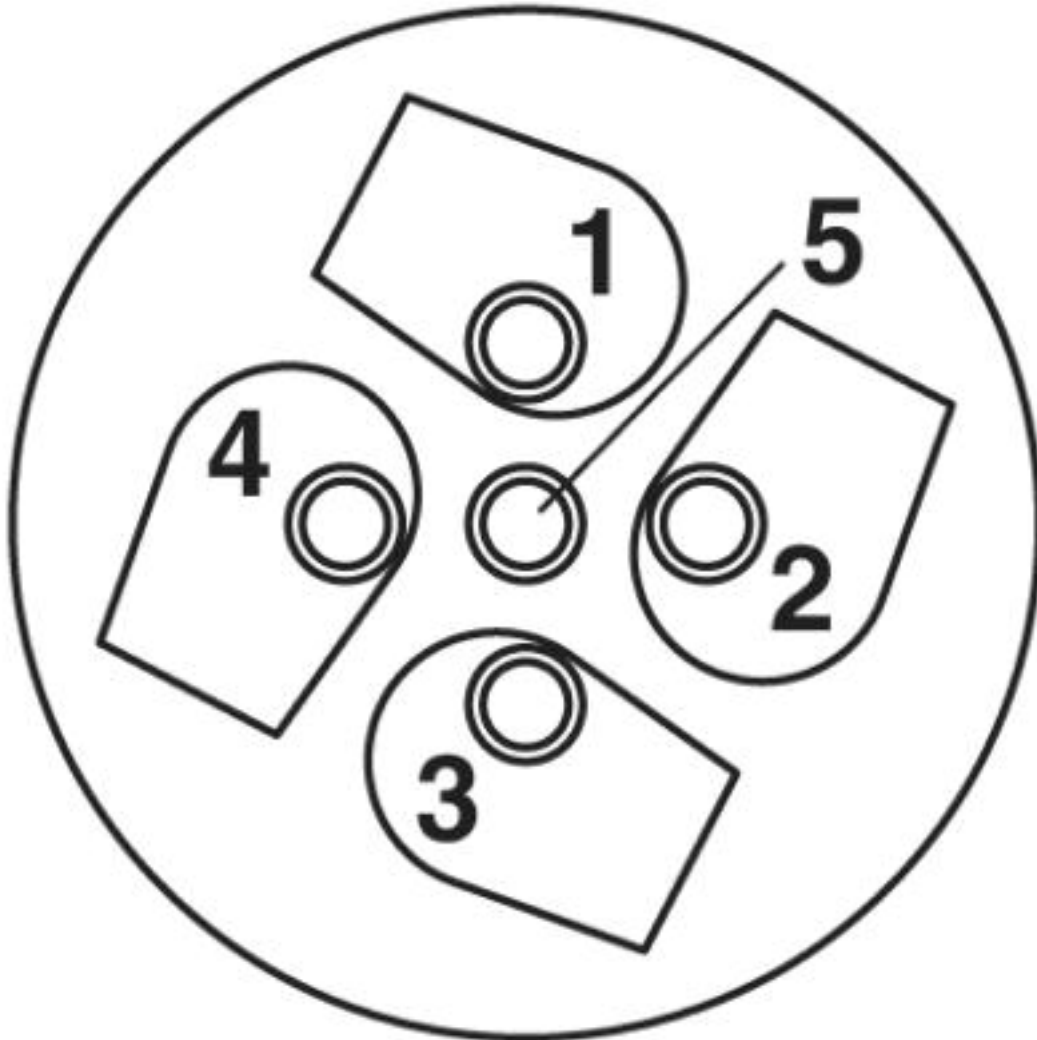

Cable connection side M12 (screw connection)

Classifications

eCl@ss

eCl@ss 4.0	27260700
eCl@ss 4.1	27260700
eCl@ss 5.0	27260700
eCl@ss 5.1	27260700
eCl@ss 6.0	27279200
eCl@ss 7.0	27440104
eCl@ss 8.0	27440104
eCl@ss 9.0	27440102

<https://www.phoenixcontact.com/gb/products/1553213>



Connector - SACC-M12MR-5CON-PG 7-VA - 1553213

Classifications

ETIM

ETIM 2.0	EC001121
ETIM 3.0	EC002062
ETIM 4.0	EC002062
ETIM 5.0	EC002062
ETIM 6.0	EC002062

UNSPSC

UNSPSC 6.01	31251501
UNSPSC 7.0901	31251501
UNSPSC 11	31251501
UNSPSC 12.01	31251501
UNSPSC 13.2	39121413

Approvals

Approvals

Approvals

UL Recognized / cUL Recognized / EAC / EAC / cULus Recognized

Ex Approvals

Approval details

UL Recognized		http://database.ul.com/cgi-bin/XYV/template/LISEXT/1FRAME/index.htm	FILE E 221474
Nominal voltage UN		125 V	
Nominal current IN		4 A	

cUL Recognized		http://database.ul.com/cgi-bin/XYV/template/LISEXT/1FRAME/index.htm	FILE E 221474
Nominal voltage UN		125 V	
Nominal current IN		4 A	

<https://www.phoenixcontact.com/gb/products/1553213>



Connector - SACC-M12MR-5CON-PG 7-VA - 1553213

Approvals

EAC		RU C- DE.AI30.B.01102
-----	---	--------------------------

EAC		EAC-Zulassung
-----	---	---------------

cULus Recognized		
------------------	---	--

Phoenix Contact 2019 © - all rights reserved
<http://www.phoenixcontact.com>



**SCATTERGOOD
& JOHNSON LTD**
ELECTRICAL ENGINEERING & FLUID CONTROL DISTRIBUTORS

Est.1899

At Scattergood & Johnson Ltd, we pride ourselves on being a technical distributor to specialist industries.

Working with a range of quality product suppliers across a number of specialist markets, we are not your average 'box shifter' - we are your technical and supply chain partner.

We fully support every product we sell - for free! Our internal team and external sales engineers can answer any product or application question, no matter the complexity.

Backing up this technical ability is a range of 50,000+ products available from stock for nationwide next day delivery (same day if required!), or you can collect what you need from any of our trade counters around the UK.

Select your specialist interest below to learn more about how we can help.



Online, In Branch and On the Road - Scattergood & Johnson Ltd, there when you need us.

www.scatts.co.uk