

Contact insert - HC-B 10-I-UT-M - 1648173

Please be informed that the data shown in this PDF Document is generated from our Online Catalog. Please find the complete data in the user's documentation. Our General Terms of Use for Downloads are valid (<http://phoenixcontact.com/download>)



HEAVYCON male insert, B10 series, 10-pos., screw connection

Your advantages

- For fast coding with plastic profile
- For test pin 2 mm



Key Commercial Data

Packing unit	1 pc
GTIN	 4 046356 092296
GTIN	4046356092296
Weight per Piece (excluding packing)	62.100 g
Custom tariff number	85366990
Country of origin	China

Technical data

General

Note	For HEAVYCON ADVANCE and HEAVYCON housing of B10 type. Plug-in connections may only be operated only when there is no load/voltage. Connectors may be operated only when there is no load/voltage.
Connection method	Screw connection
Tightening torque	0.5 Nm ... 0.8 Nm
Screwdriver blade	0.5 x 3.5 mm
Number of connections per position	1
Degree of pollution	3
Overvoltage category	III
Number of positions	10+PE
Insertion/withdrawal cycles	≥ 500

Contact insert - HC-B 10-I-UT-M - 1648173

Technical data

General

Size	B10
Contact numbering	1 - 10
Conductor cross section	0.5 mm ² ... 2.5 mm ² (applies to stranded conductors with ferrules)
Connection cross section AWG	20 ... 14
Stripping length of the individual wire	8 mm
Assembly instructions	To ensure correct use, installation in housing with IP54 protection or better is required
Connection	For housings of type B10. Connectors may only be actuated when there is no load/voltage.

Ambient conditions

Ambient temperature (operation)	-40 °C ... 125 °C (including heating up of contacts)
---------------------------------	--

Material data

Contact material	Copper alloy
Contact surface material	Ag
Contact carrier material	PC

Electrical characteristics

Rated voltage (III/3)	500 V
Rated surge voltage	6 kV
Rated current	24 A

Standards and Regulations

Connection in acc. with standard	CSA
Constructional and testing regulations	DIN EN 61984
	DIN EN 60664
	IEC 60352
Flammability rating according to UL 94	V0

Environmental Product Compliance

	Lead 7439-92-1
China RoHS	Environmentally Friendly Use Period = 50
	For details about hazardous substances go to tab "Downloads", Category "Manufacturer's declaration"

Drawings

Contact insert - HC-B 10-I-UT-M - 1648173

Schematic diagram

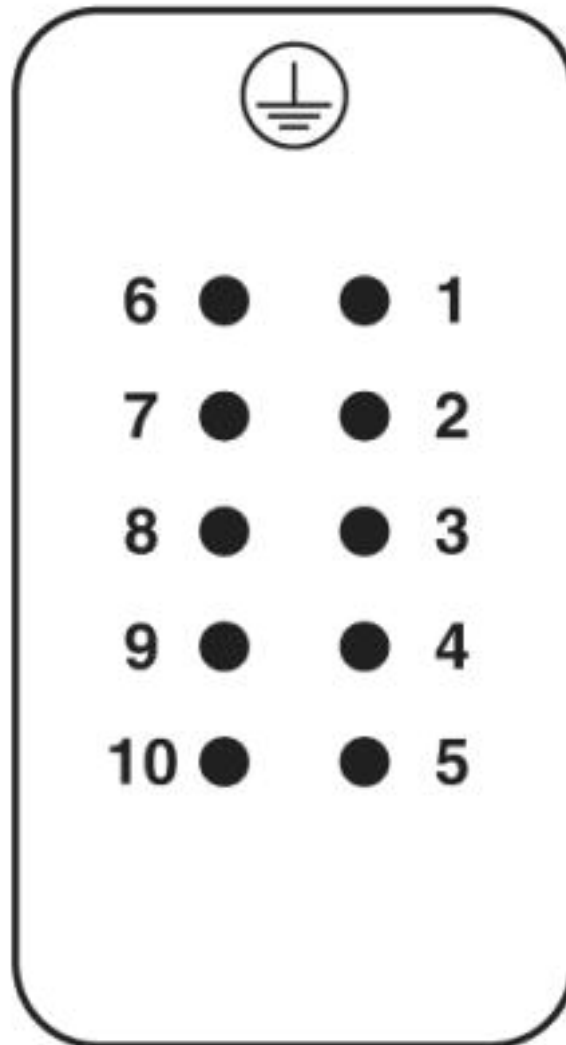

Connector pin assignment, connection side

Contact insert - HC-B 10-I-UT-M - 1648173

Diagram

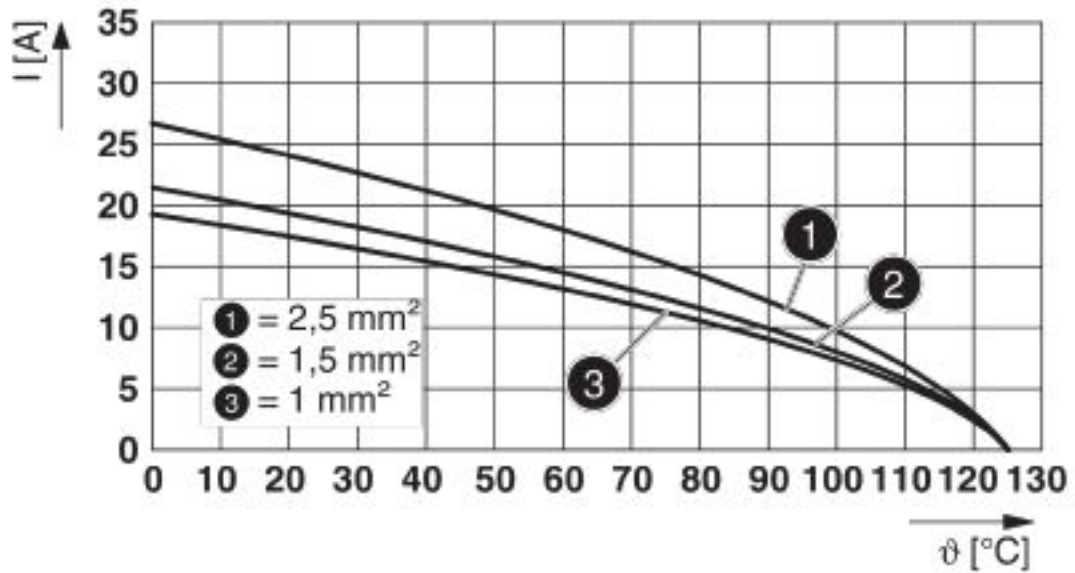

Derating diagram

Dimensional drawing

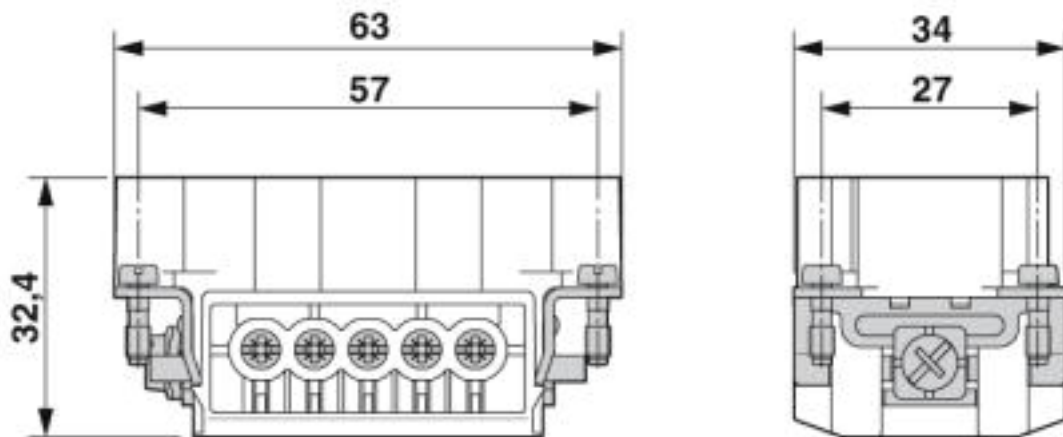

Male insert

Contact insert - HC-B 10-I-UT-M - 1648173

Dimensional drawing

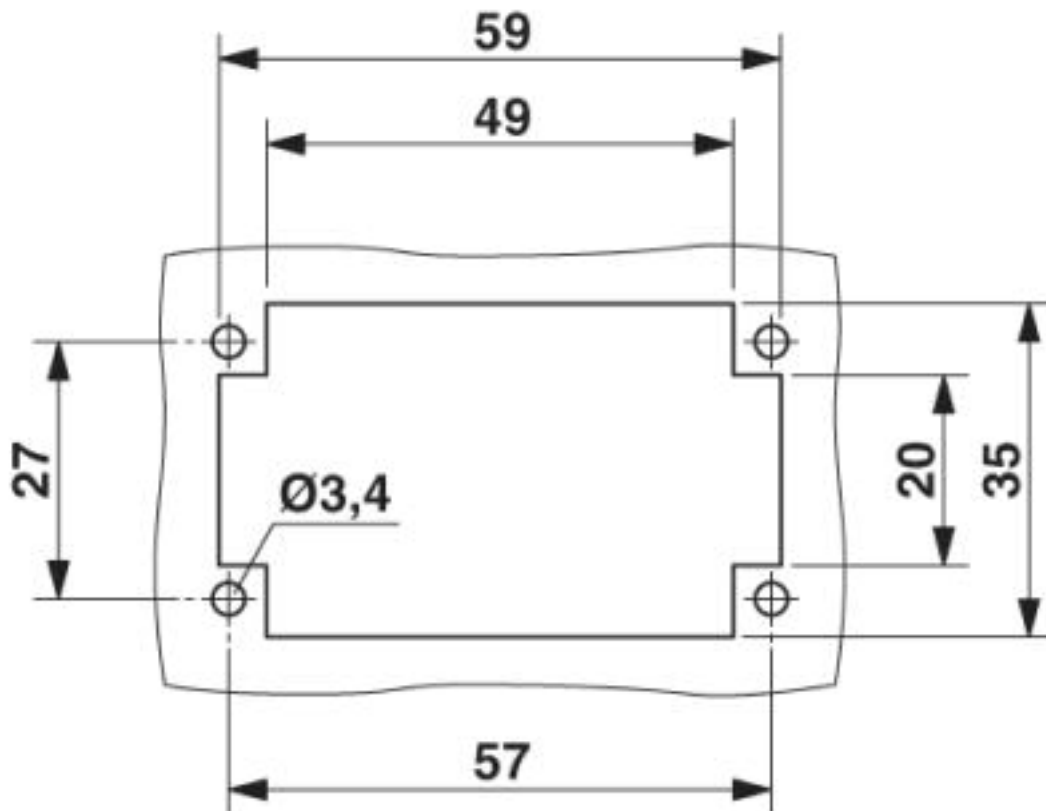

Mounting cutout when used without housing

Classifications

eCl@ss

eCl@ss 4.0	27140800
eCl@ss 4.1	27140800
eCl@ss 5.0	27143400
eCl@ss 5.1	27261200
eCl@ss 6.0	27261200
eCl@ss 7.0	27440205
eCl@ss 8.0	27440205
eCl@ss 9.0	27440205

ETIM

ETIM 3.0	EC000438
ETIM 4.0	EC000438
ETIM 5.0	EC000438
ETIM 6.0	EC000438
ETIM 7.0	EC000438



Contact insert - HC-B 10-I-UT-M - 1648173

Classifications

UNSPSC

UNSPSC 6.01	30211923
UNSPSC 7.0901	39121522
UNSPSC 11	39121522
UNSPSC 12.01	39121522
UNSPSC 13.2	39121522

Approvals

Approvals

Approvals

CSA / UL Recognized / EAC / DNV GL

Ex Approvals

Approval details

CSA		http://www.csagroup.org/services-industries/product-listing/	013631_6233_01
Nominal voltage UN		600 V	
Nominal current IN		13 A	
mm ² /AWG/kcmil		22-14	

UL Recognized		http://database.ul.com/cgi-bin/XYVV/template/LISEXT/1FRAME/index.htm	FILE E 118976
Nominal voltage UN		600 V	
Nominal current IN		16 A	
mm ² /AWG/kcmil		14	

EAC			RU C- DE.AI30.B.01102
-----	---	--	--------------------------

DNV GL		https://approvalfinder.dnvgl.com/	TAE000037S
--------	---	---	------------

<https://www.phoenixcontact.com/gb/products/1648173>



Phoenix Contact 2019 © - all rights reserved
<http://www.phoenixcontact.com>



SCATTERGOOD & JOHNSON LTD

ELECTRICAL ENGINEERING & FLUID CONTROL DISTRIBUTORS

Est.1899

At Scattergood & Johnson Ltd, we pride ourselves on being a technical distributor to specialist industries.

Working with a range of quality product suppliers across a number of specialist markets, we are not your average 'box shifter' - we are your technical and supply chain partner.

We fully support every product we sell - for free! Our internal team and external sales engineers can answer any product or application question, no matter the complexity.

Backing up this technical ability is a range of 50,000+ products available from stock for nationwide next day delivery (same day if required!), or you can collect what you need from any of our trade counters around the UK.

Select your specialist interest below to learn more about how we can help.



Online, In Branch and On the Road - Scattergood & Johnson Ltd, there when you need us.

www.scatts.co.uk