

Printed-circuit board connector - MSTBA 2,5/ 5-G-5,08 - 1757271

Please be informed that the data shown in this PDF Document is generated from our Online Catalog. Please find the complete data in the user's documentation. Our General Terms of Use for Downloads are valid (<http://phoenixcontact.com/download>)

PCB headers, nominal current: 12 A, number of positions: 5, pitch: 5.08 mm, color: green, contact surface: Tin, mounting: Wave soldering



The figure shows a 10-position version of the product

Your advantages

- ✓ Maximum flexibility when it comes to device design – one header for connectors with different connection technologies
- ✓ Well-known mounting principle allows worldwide use
- ✓ Plug-in direction parallel to the PCB
- ✓ Closed contour for optimum stability of the plug-in connection
- ✓ Easy PCB replacement thanks to plug-in modules



Key Commercial Data

Packing unit	250 pc
Minimum order quantity	250 pc
GTIN	 4 017918 029807
GTIN	4017918029807
Weight per Piece (excluding packing)	1.990 g
Custom tariff number	85366930
Country of origin	Germany

Technical data

Dimensions

Length [l]	12 mm
Width	27.32 mm
Pitch	5.08 mm
Dimension a	20.32 mm
Width [w]	27.32 mm
Height [h]	12.1 mm

Printed-circuit board connector - MSTBA 2,5/ 5-G-5,08 - 1757271

Technical data

Dimensions

Height	8.6 mm
Length of the solder pin	3.5 mm
Pin dimensions	1 x 1 mm
Length	12 mm

General

Range of articles	MSTBA 2,5/..-G
Insulating material group	I
Rated surge voltage (III/3)	4 kV
Rated surge voltage (III/2)	4 kV
Rated surge voltage (II/2)	4 kV
Rated voltage (III/3)	250 V
Rated voltage (III/2)	320 V
Rated voltage (II/2)	400 V
Connection in acc. with standard	EN-VDE
Nominal current I_N	12 A
Maximum load current	12 A
Insulating material	PA
Flammability rating according to UL 94	V0
Color	green
Number of positions	5

Standards and Regulations

Connection in acc. with standard	EN-VDE
	CSA
Flammability rating according to UL 94	V0

Environmental Product Compliance

China RoHS	Environmentally friendly use period: unlimited = EFUP-e
	No hazardous substances above threshold values

Drawings

Printed-circuit board connector - MSTBA 2,5/ 5-G-5,08 - 1757271

Drilling diagram

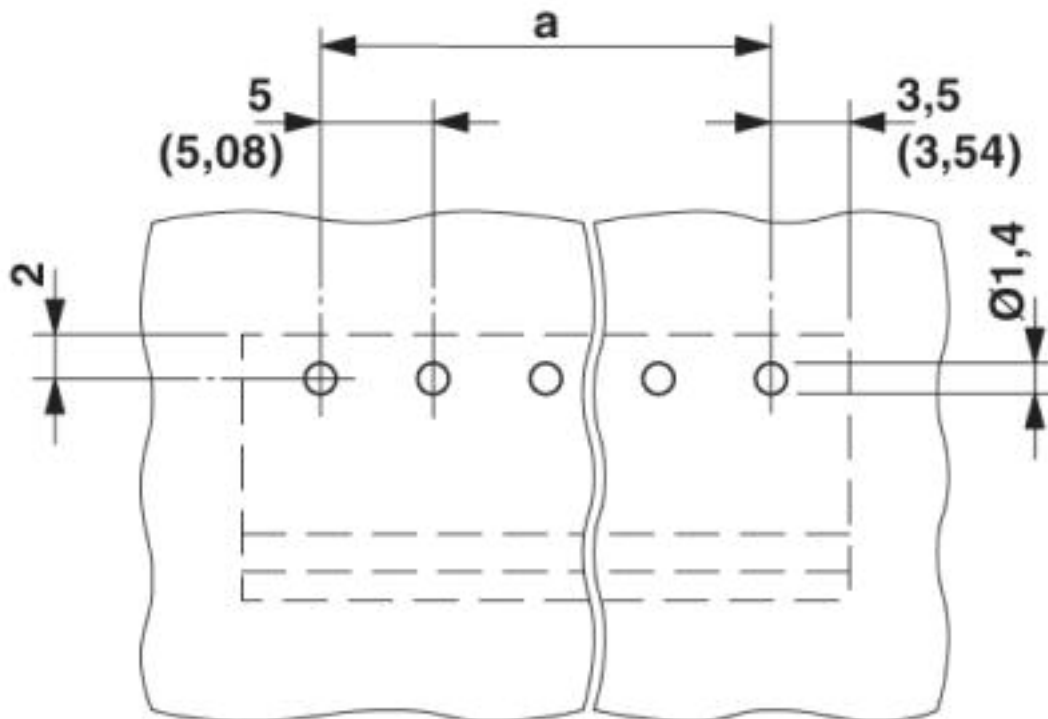

Diagram

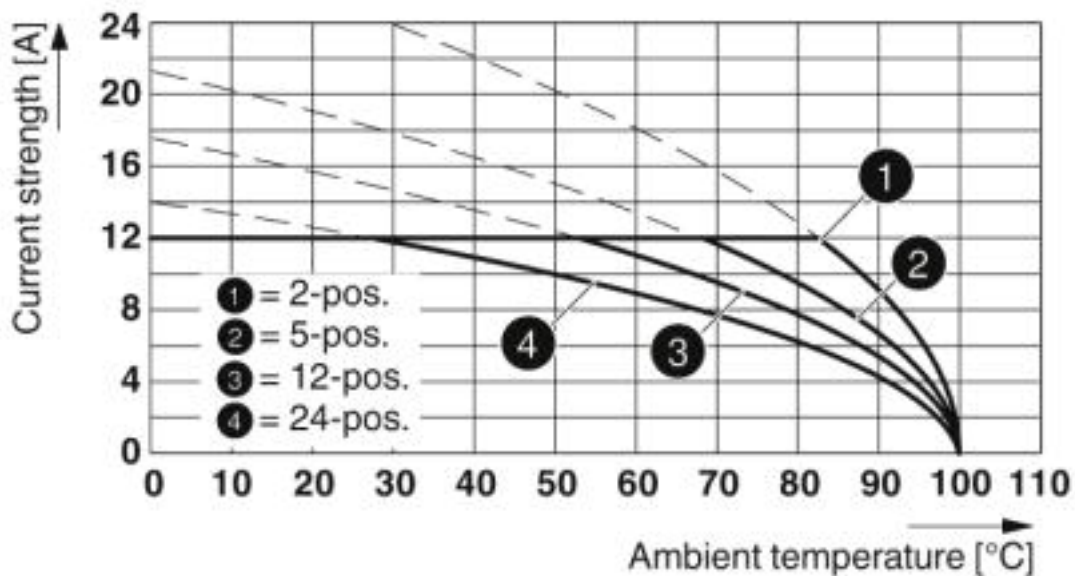

Type: ICV 2,5/...-G-5,08 with MSTBA 2,5/...-G-5,08

Printed-circuit board connector - MSTBA 2,5/ 5-G-5,08 - 1757271

Diagram

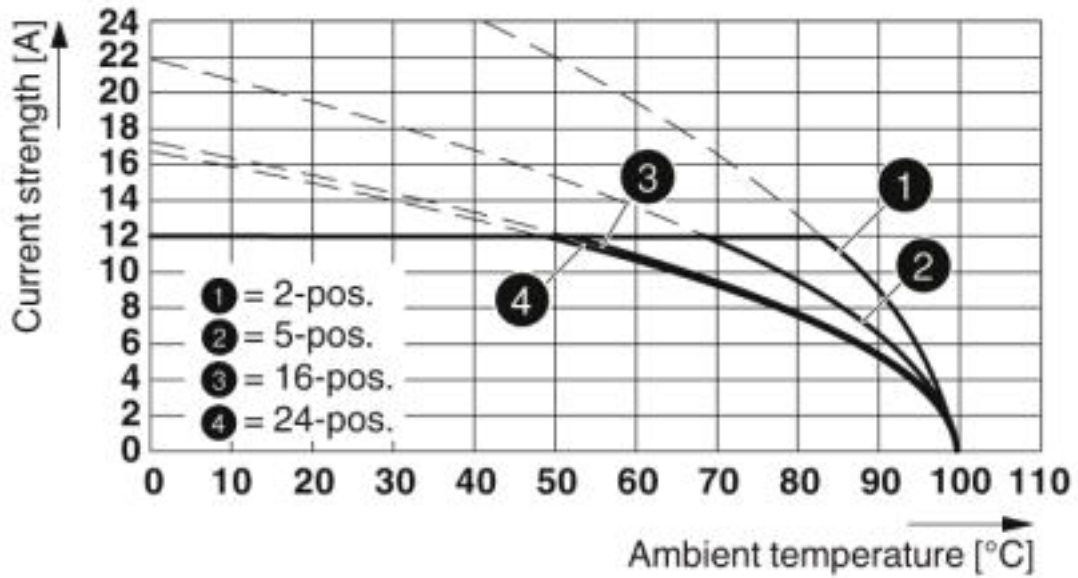

Type: IC 2,5/...-G-5,08 with MSTBA 2,5/...-G-5,08

Dimensional drawing

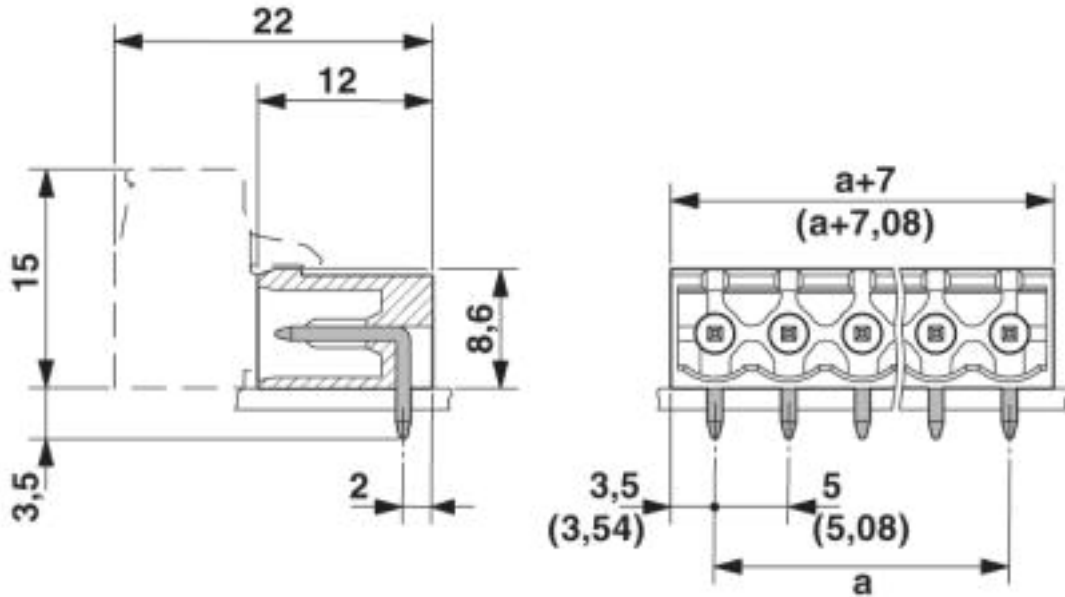

Classifications

eCl@ss

eCl@ss 4.0	27260700
eCl@ss 4.1	27260700
eCl@ss 5.0	27260700

<https://www.phoenixcontact.com/gb/products/1757271>



Printed-circuit board connector - MSTBA 2,5/ 5-G-5,08 - 1757271

Classifications

eCl@ss

eCl@ss 5.1	27260700
eCl@ss 6.0	27260700
eCl@ss 7.0	27440402
eCl@ss 8.0	27440402
eCl@ss 9.0	27440402

ETIM

ETIM 3.0	EC001121
ETIM 4.0	EC002637
ETIM 5.0	EC002637
ETIM 6.0	EC002637
ETIM 7.0	EC002637

UNSPSC

UNSPSC 6.01	30211810
UNSPSC 7.0901	39121409
UNSPSC 11	39121409
UNSPSC 12.01	39121409
UNSPSC 13.2	39121409

Approvals

Approvals

Approvals

CSA / IEC/IEC CB Scheme / VDE Gutachten mit Fertigungsüberwachung / EAC / cULus Recognized

Ex Approvals

Approval details

CSA		http://www.csagroup.org/services-industries/product-listing/	LR13631-2585950
	B	D	
Nominal voltage UN	300 V	300 V	
Nominal current IN	10 A	10 A	

<https://www.phoenixcontact.com/gb/products/1757271>



Printed-circuit board connector - MSTBA 2,5/ 5-G-5,08 - 1757271

Approvals

IECEE CB Scheme		http://www.iecee.org/	DE1-60988-B1B2
Nominal voltage UN	250 V		
Nominal current IN	12 A		

VDE Gutachten mit Fertigungsüberwachung		http://www2.vde.com/de/Institut/Online-Service/VDE-gepruefteProdukte/Seiten/Online-Suche.aspx	40004701
Nominal voltage UN	250 V		
Nominal current IN	12 A		

EAC		B.01742
-----	--	---------

cULus Recognized		http://database.ul.com/cgi-bin/XYV/template/LISEXT/1FRAME/index.htm	E60425-19931011
	B	D	
Nominal voltage UN	300 V	300 V	
Nominal current IN	15 A	10 A	

Phoenix Contact 2019 © - all rights reserved
<http://www.phoenixcontact.com>



SCATTERGOOD & JOHNSON LTD

ELECTRICAL ENGINEERING & FLUID CONTROL DISTRIBUTORS

Est.1899

At Scattergood & Johnson Ltd, we pride ourselves on being a technical distributor to specialist industries.

Working with a range of quality product suppliers across a number of specialist markets, we are not your average 'box shifter' - we are your technical and supply chain partner.

We fully support every product we sell - for free! Our internal team and external sales engineers can answer any product or application question, no matter the complexity.

Backing up this technical ability is a range of 50,000+ products available from stock for nationwide next day delivery (same day if required!), or you can collect what you need from any of our trade counters around the UK.

Select your specialist interest below to learn more about how we can help.



Online, In Branch and On the Road - Scattergood & Johnson Ltd, there when you need us.

www.scatts.co.uk