

Feed-through header - MSTBV 2,5/ 3-G-5,08 - 1758021

Please be informed that the data shown in this PDF Document is generated from our Online Catalog. Please find the complete data in the user's documentation. Our General Terms of Use for Downloads are valid (<http://phoenixcontact.com/download>)

PCB headers, nominal current: 12 A, number of positions: 3, pitch: 5.08 mm, color: green, contact surface: Tin, mounting: Wave soldering



The figure shows a 10-position version of the product

Your advantages

- ✓ Maximum flexibility when it comes to device design – one header for connectors with different connection technologies
- ✓ Well-known mounting principle allows worldwide use
- ✓ Vertical connection enables multi-row arrangement on the PCB
- ✓ Items that can be aligned in various pitches support flexible and space-saving PCB assembly
- ✓ Easy PCB replacement thanks to plug-in modules



Key Commercial Data

| | |
|--------------------------------------|---|
| Packing unit | 250 pc |
| Minimum order quantity | 250 pc |
| GTIN |  4 017918 030230 |
| GTIN | 4017918030230 |
| Weight per Piece (excluding packing) | 0.920 g |
| Custom tariff number | 85366930 |
| Country of origin | Germany |

Technical data

Dimensions

| | |
|--------------|----------|
| Length [l] | 8.57 mm |
| Width | 15.24 mm |
| Pitch | 5.08 mm |
| Dimension a | 10.16 mm |
| Width [w] | 15.24 mm |
| Height [h] | 15.9 mm |

Feed-through header - MSTBV 2,5/ 3-G-5,08 - 1758021

Technical data

Dimensions

| | |
|--------------------------|----------|
| Height | 12 mm |
| Length of the solder pin | 3.9 mm |
| Pin dimensions | 1 x 1 mm |
| Length | 8.57 mm |

General

| | |
|--|----------------|
| Range of articles | MSTBV 2,5/..-G |
| Insulating material group | I |
| Rated surge voltage (III/3) | 4 kV |
| Rated surge voltage (III/2) | 4 kV |
| Rated surge voltage (II/2) | 4 kV |
| Rated voltage (III/3) | 250 V |
| Rated voltage (III/2) | 320 V |
| Rated voltage (II/2) | 400 V |
| Connection in acc. with standard | EN-VDE |
| Nominal current I_N | 12 A |
| Maximum load current | 12 A |
| Insulating material | PA |
| Flammability rating according to UL 94 | V0 |
| Color | green |
| Number of positions | 3 |

Standards and Regulations

| | |
|--|--------|
| Connection in acc. with standard | EN-VDE |
| | CSA |
| Flammability rating according to UL 94 | V0 |

Environmental Product Compliance

| | |
|------------|---|
| China RoHS | Environmentally friendly use period: unlimited = EFUP-e |
| | No hazardous substances above threshold values |

Drawings

Feed-through header - MSTBV 2,5/ 3-G-5,08 - 1758021

Drilling diagram

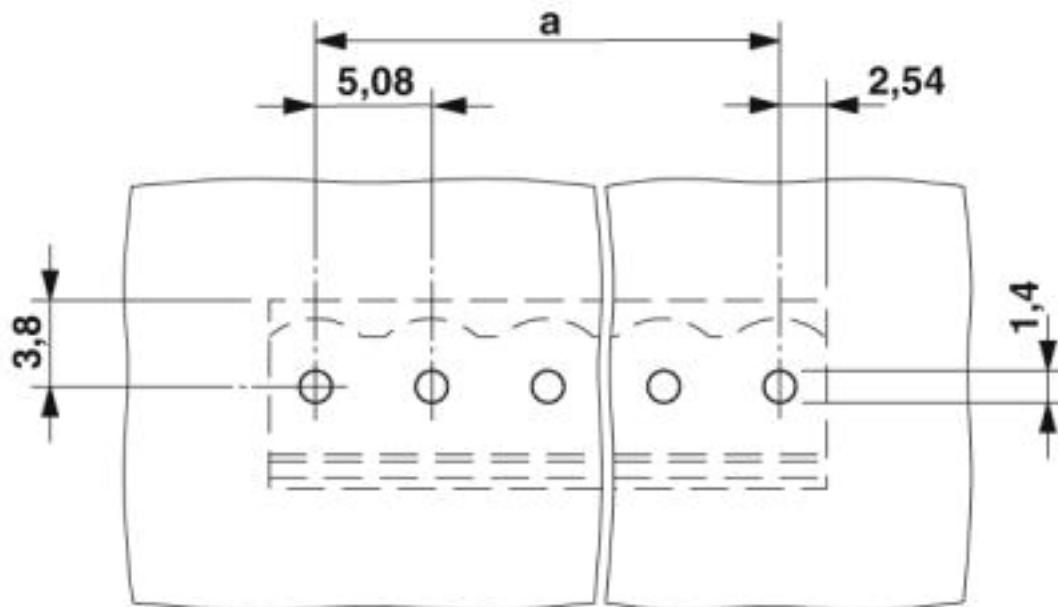

Diagram

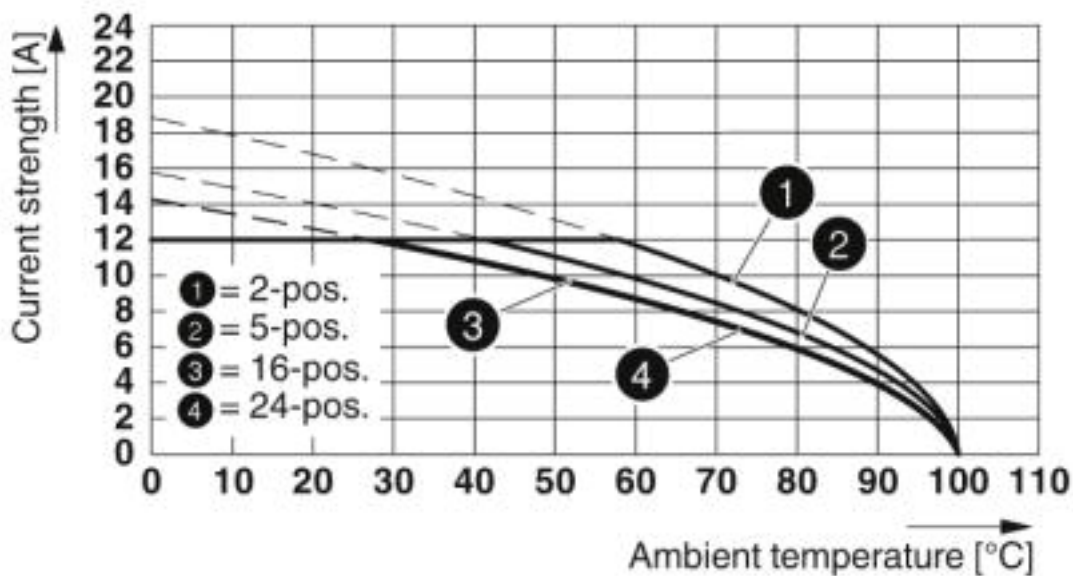

Type: MSTBP 2,5/...-ST-5,08 with MSTBV 2,5/...-G-5,08

Feed-through header - MSTBV 2,5/ 3-G-5,08 - 1758021

Diagram

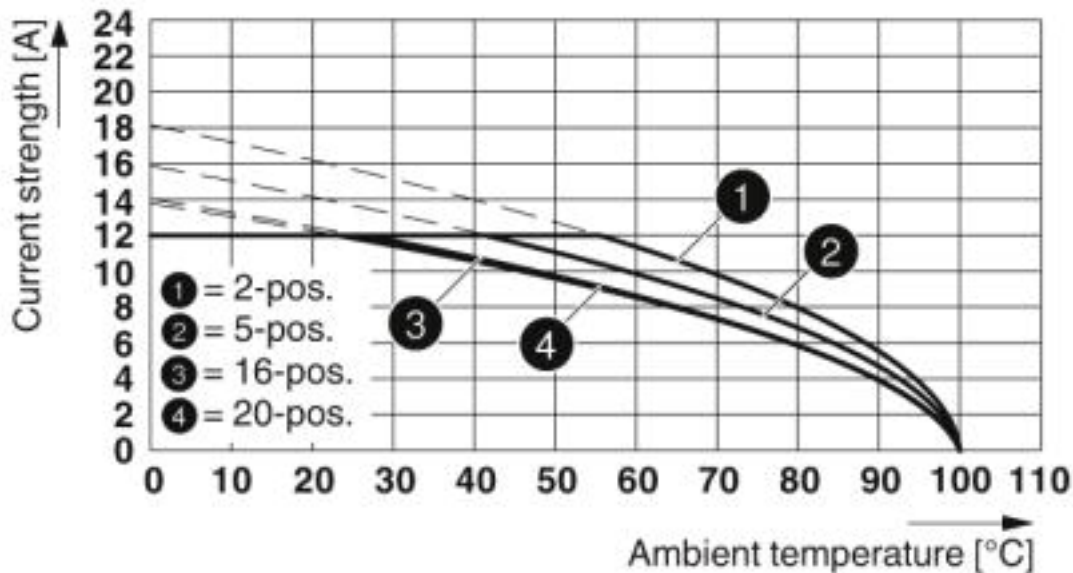

Type: MSTB 2,5/...-ST-5,08 with MSTBV 2,5/...-G-5,08

Diagram

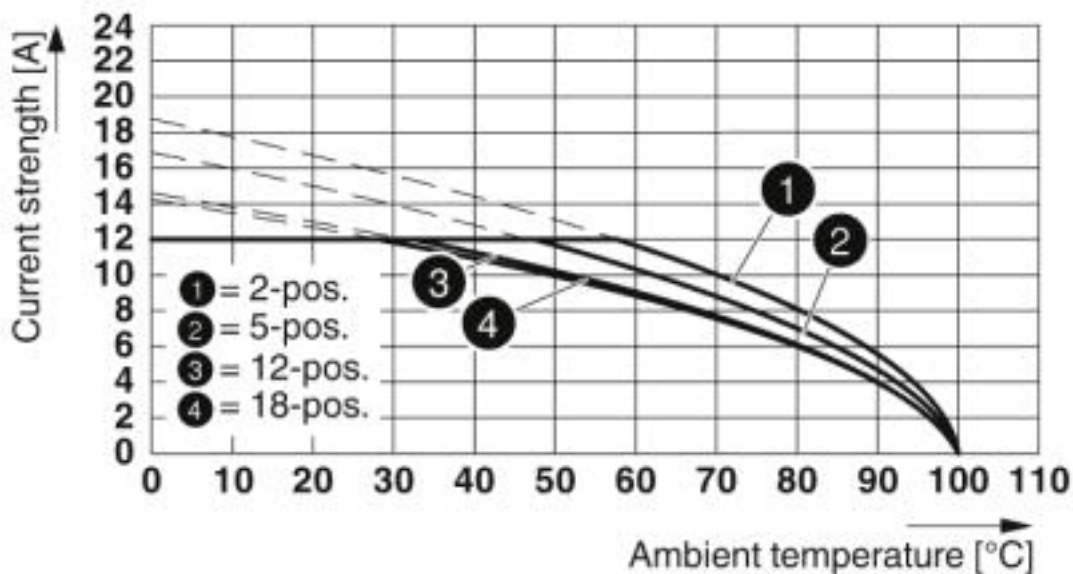

Type: MSTBT 2,5/...-ST-5,08 with MSTBV 2,5/...-G-5,08-5,08

Feed-through header - MSTBV 2,5/ 3-G-5,08 - 1758021

Diagram

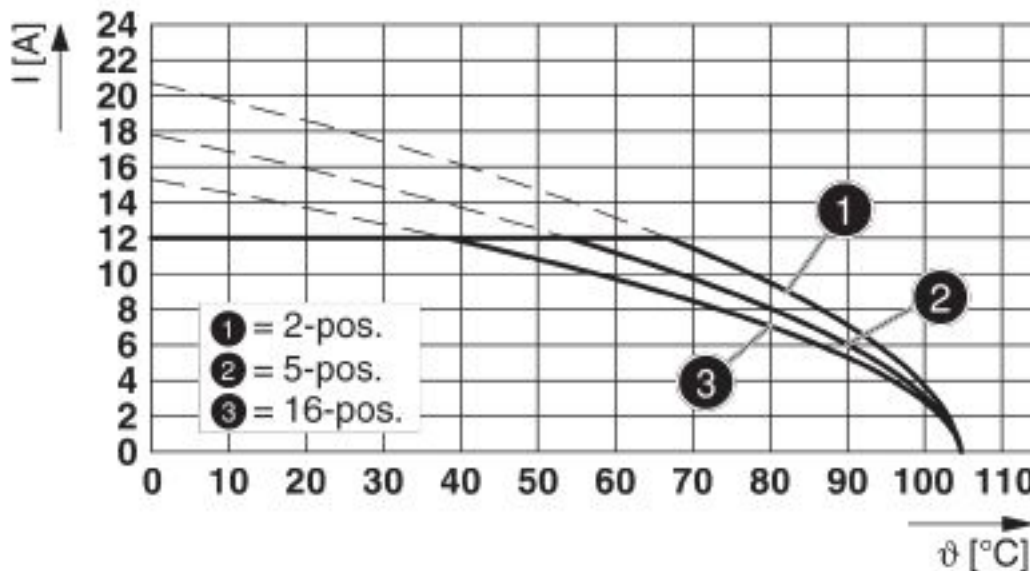

Type: FKCVR 2,5/...-ST-5,08 with MSTBV 2,5/...-G-5,08

Diagram

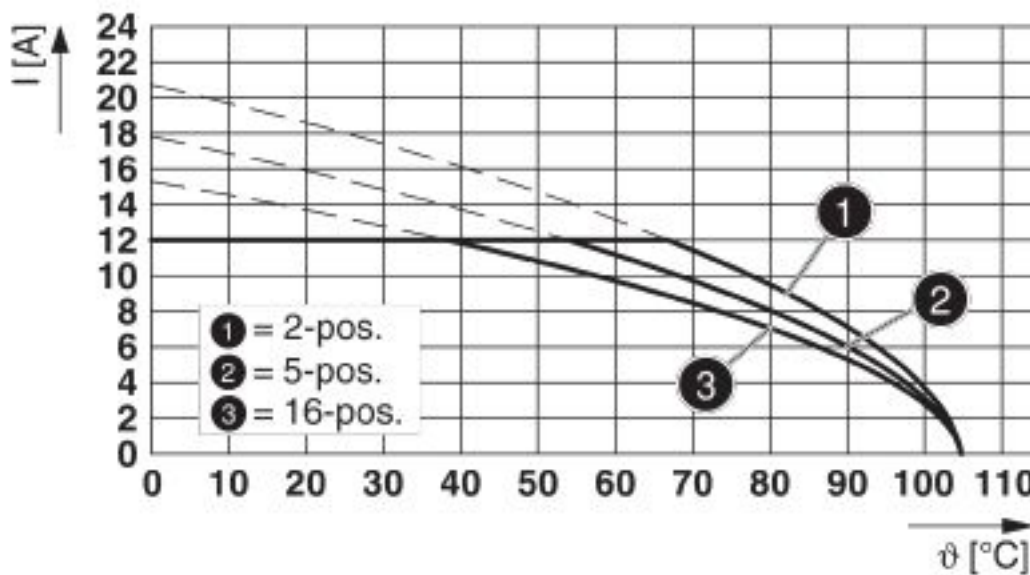

Type: FKCVR 2,5/...-ST-5,08 with MSTBV 2,5/...-G-5,08

Feed-through header - MSTBV 2,5/ 3-G-5,08 - 1758021

Dimensional drawing

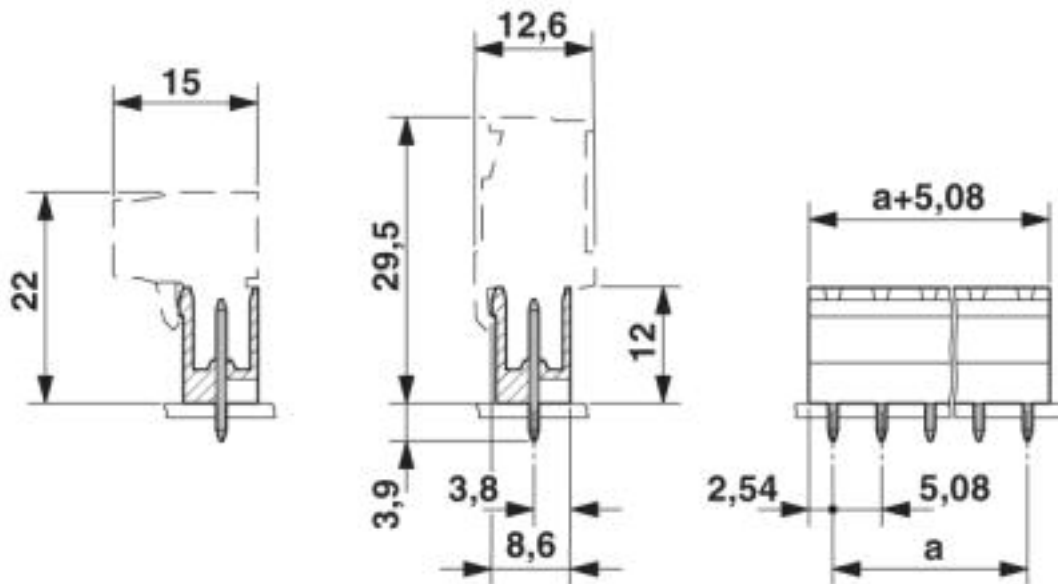

Classifications

eCl@ss

| | |
|------------|----------|
| eCl@ss 4.0 | 27260700 |
| eCl@ss 4.1 | 27260700 |
| eCl@ss 5.0 | 27260700 |
| eCl@ss 5.1 | 27260700 |
| eCl@ss 6.0 | 27260700 |
| eCl@ss 7.0 | 27440402 |
| eCl@ss 8.0 | 27440402 |
| eCl@ss 9.0 | 27440402 |

ETIM

| | |
|----------|----------|
| ETIM 3.0 | EC001121 |
| ETIM 4.0 | EC002637 |
| ETIM 5.0 | EC002637 |
| ETIM 6.0 | EC002637 |
| ETIM 7.0 | EC002637 |

UNSPSC

| | |
|---------------|----------|
| UNSPSC 6.01 | 30211810 |
| UNSPSC 7.0901 | 39121409 |
| UNSPSC 11 | 39121409 |
| UNSPSC 12.01 | 39121409 |
| UNSPSC 13.2 | 39121409 |

<https://www.phoenixcontact.com/gb/products/1758021>



Feed-through header - MSTBV 2,5/ 3-G-5,08 - 1758021

Approvals

Approvals

Approvals

CSA / IECCEB CB Scheme / VDE Gutachten mit Fertigungsüberwachung / EAC / cULus Recognized

Ex Approvals

Approval details

| | | | |
|--------------------|---|---|-------|
| CSA |  | http://www.csagroup.org/services-industries/product-listing/ | 13631 |
| | | B | D |
| Nominal voltage UN | | 300 V | 300 V |
| Nominal current IN | | 12 A | 10 A |

| | | | |
|--------------------|---|---|----------------|
| IECEE CB Scheme |  | http://www.iecee.org/ | DE1-60988-B1B2 |
| Nominal voltage UN | | 250 V | |
| Nominal current IN | | 12 A | |

| | | | |
|--|---|--|----------|
| VDE Gutachten mit Fertigungsüberwachung |  | http://www2.vde.com/de/Institut/Online-Service/ VDE-gepruefteProdukte/Seiten/Online-Suche.aspx | 40004701 |
| Nominal voltage UN | | 250 V | |
| Nominal current IN | | 12 A | |

| | | | |
|-----|---|--|---------|
| EAC |  | | B.01742 |
|-----|---|--|---------|

| | | | |
|--------------------|---|---|-----------------|
| cULus Recognized |  | http://database.ul.com/cgi-bin/XYV/template/LISEXT/1FRAME/index.htm | E60425-19931011 |
| | | B | D |
| Nominal voltage UN | | 300 V | 300 V |
| Nominal current IN | | 12 A | 10 A |

<https://www.phoenixcontact.com/gb/products/1758021>



Phoenix Contact 2019 © - all rights reserved
<http://www.phoenixcontact.com>



SCATTERGOOD & JOHNSON LTD

ELECTRICAL ENGINEERING & FLUID CONTROL DISTRIBUTORS

Est.1899

At Scattergood & Johnson Ltd, we pride ourselves on being a technical distributor to specialist industries.

Working with a range of quality product suppliers across a number of specialist markets, we are not your average 'box shifter' - we are your technical and supply chain partner.

We fully support every product we sell - for free! Our internal team and external sales engineers can answer any product or application question, no matter the complexity.

Backing up this technical ability is a range of 50,000+ products available from stock for nationwide next day delivery (same day if required!), or you can collect what you need from any of our trade counters around the UK.

Select your specialist interest below to learn more about how we can help.



Online, In Branch and On the Road - Scattergood & Johnson Ltd, there when you need us.

www.scatts.co.uk