

Feed-through header - GMSTBVA 2,5/ 4-G-7,62 - 1766796

Please be informed that the data shown in this PDF Document is generated from our Online Catalog. Please find the complete data in the user's documentation. Our General Terms of Use for Downloads are valid (<http://phoenixcontact.com/download>)

PCB headers, nominal current: 12 A, number of positions: 4, pitch: 7.62 mm, color: green, contact surface: Tin, mounting: Wave soldering



The figure shows a 10-position version of the product

Your advantages

- ✓ Maximum flexibility when it comes to device design – one header for connectors with different connection technologies
- ✓ Well-known mounting principle allows worldwide use
- ✓ Larger pitch for increased voltage requirements
- ✓ Closed contour for optimum stability of the plug-in connection
- ✓ Vertical connection enables multi-row arrangement on the PCB

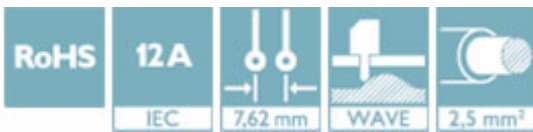

Key Commercial Data

Packing unit	250 pc
Minimum order quantity	250 pc
GTIN	 4 017918 032814
GTIN	4017918032814
Weight per Piece (excluding packing)	1.950 g
Custom tariff number	85366930
Country of origin	Germany

Technical data

Dimensions

Length [l]	8.6 mm
Width	30.48 mm
Pitch	7.62 mm
Dimension a	22.86 mm
Width [w]	30.48 mm
Height [h]	15.9 mm

Feed-through header - GMSTBVA 2,5/ 4-G-7,62 - 1766796

Technical data

Dimensions

Height	12 mm
Length of the solder pin	3.9 mm
Pin dimensions	1 x 1 mm
Length	8.6 mm

General

Range of articles	GMSTBVA 2,5/...-G
Insulating material group	I
Rated surge voltage (III/3)	6 kV
Rated surge voltage (III/2)	6 kV
Rated surge voltage (II/2)	6 kV
Rated voltage (III/3)	400 V
Rated voltage (III/2)	630 V
Rated voltage (II/2)	630 V
Connection in acc. with standard	EN-VDE
Nominal current I_N	12 A
Maximum load current	12 A
Insulating material	PA
Flammability rating according to UL 94	V0
Color	green
Number of positions	4

Standards and Regulations

Connection in acc. with standard	EN-VDE
	CSA
Flammability rating according to UL 94	V0

Environmental Product Compliance

China RoHS	Environmentally friendly use period: unlimited = EFUP-e
	No hazardous substances above threshold values

Drawings

Feed-through header - GMSTBVA 2,5/ 4-G-7,62 - 1766796

Drilling diagram

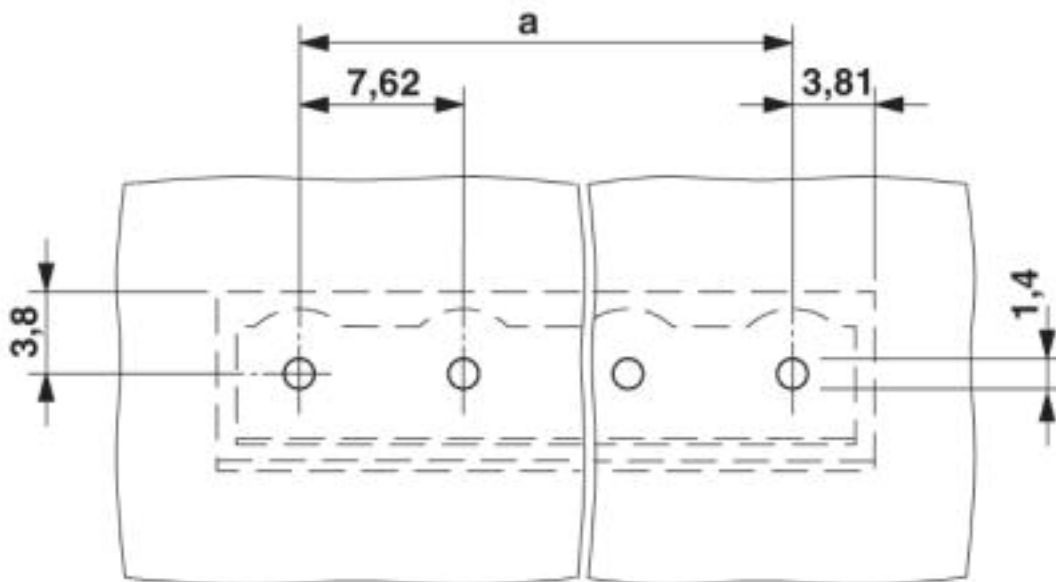

Diagram

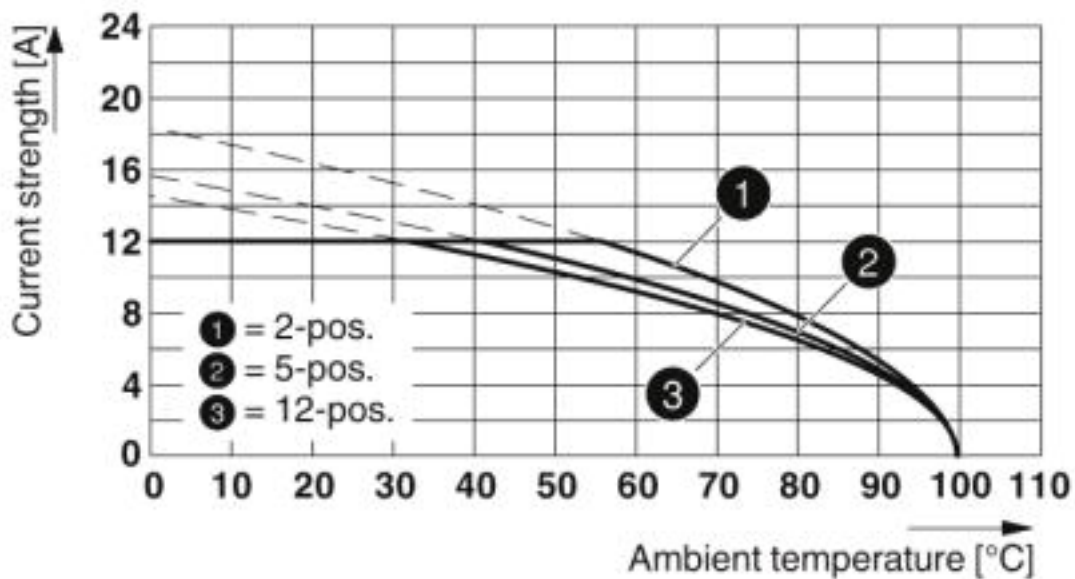

Type: GMSTB 2,5/...-ST-7,62 with GMSTBVA 2,5/...-G-7,62

Feed-through header - GMSTBVA 2,5/ 4-G-7,62 - 1766796

Dimensional drawing

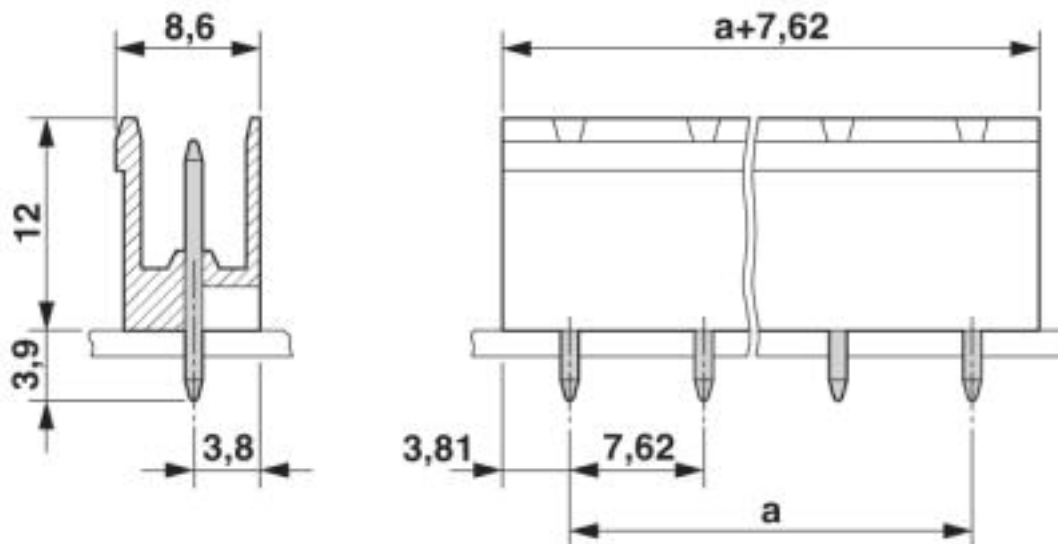

Classifications

eCl@ss

eCl@ss 4.0	27260700
eCl@ss 4.1	27260700
eCl@ss 5.0	27260700
eCl@ss 5.1	27260700
eCl@ss 6.0	27260700
eCl@ss 7.0	27440402
eCl@ss 8.0	27440402
eCl@ss 9.0	27440402

ETIM

ETIM 3.0	EC001121
ETIM 4.0	EC002637
ETIM 5.0	EC002637
ETIM 6.0	EC002637
ETIM 7.0	EC002637

UNSPSC

UNSPSC 6.01	30211810
UNSPSC 7.0901	39121409
UNSPSC 11	39121409
UNSPSC 12.01	39121409
UNSPSC 13.2	39121409

<https://www.phoenixcontact.com/gb/products/1766796>



Feed-through header - GMSTBVA 2,5/ 4-G-7,62 - 1766796

Approvals

Approvals

Approvals

CSA / IEC/EEB CB Scheme / VDE Gutachten mit Fertigungsüberwachung / EAC / cULus Recognized

Ex Approvals

Approval details

CSA		http://www.csagroup.org/services-industries/product-listing/	13631
		B	D
Nominal voltage UN		300 V	300 V
Nominal current IN		10 A	10 A

IECEE CB Scheme		http://www.iecee.org/	DE1-60988-B1B2
Nominal voltage UN		400 V	
Nominal current IN		12 A	

VDE Gutachten mit Fertigungsüberwachung		http://www2.vde.com/de/Institut/Online-Service/ VDE-gepruefteProdukte/Seiten/Online-Suche.aspx	40004701
Nominal voltage UN		400 V	
Nominal current IN		12 A	

EAC			B.01742
-----	---	--	---------

cULus Recognized		http://database.ul.com/cgi-bin/XYV/template/LISEXT/1FRAME/index.htm	E60425-19931013
		B	D
Nominal voltage UN		300 V	300 V
Nominal current IN		15 A	10 A

<https://www.phoenixcontact.com/gb/products/1766796>



Phoenix Contact 2019 © - all rights reserved
<http://www.phoenixcontact.com>



SCATTERGOOD & JOHNSON LTD

ELECTRICAL ENGINEERING & FLUID CONTROL DISTRIBUTORS

Est.1899

At Scattergood & Johnson Ltd, we pride ourselves on being a technical distributor to specialist industries.

Working with a range of quality product suppliers across a number of specialist markets, we are not your average 'box shifter' - we are your technical and supply chain partner.

We fully support every product we sell - for free! Our internal team and external sales engineers can answer any product or application question, no matter the complexity.

Backing up this technical ability is a range of 50,000+ products available from stock for nationwide next day delivery (same day if required!), or you can collect what you need from any of our trade counters around the UK.

Select your specialist interest below to learn more about how we can help.



Online, In Branch and On the Road - Scattergood & Johnson Ltd, there when you need us.

www.scatts.co.uk