

Printed-circuit board connector - PC 4/ 6-ST-7,62 - 1804946

Please be informed that the data shown in this PDF Document is generated from our Online Catalog. Please find the complete data in the user's documentation. Our General Terms of Use for Downloads are valid (<http://phoenixcontact.com/download>)



PCB connector, nominal current: 20 A, number of positions: 6, pitch: 7.62 mm, connection method: Screw connection with tension sleeve, color: green, contact surface: Tin

The figure shows a 5-pos. version of the product

Your advantages

- Well-known connection principle allows worldwide use
- Low temperature rise, thanks to maximum contact force
- Allows connection of two conductors
- Integrated double steel spring provides additional safety in the event of temperature and power fluctuations

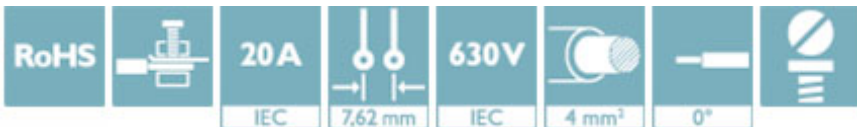

Key Commercial Data

Packing unit	50 pc
Minimum order quantity	50 pc
GTIN	 4 017918 046385
GTIN	4017918046385
Weight per Piece (excluding packing)	24.520 g
Custom tariff number	85366990
Country of origin	Germany

Technical data

Dimensions

Length [l]	30.7 mm
Width [w]	45.7 mm
Height [h]	18.1 mm
Pitch	7.62 mm
Dimension a	38.1 mm

General

Range of articles	PC 4/..-ST
-------------------	------------

Printed-circuit board connector - PC 4/ 6-ST-7,62 - 1804946

Technical data

General

Number of positions	6
Connection method	Screw connection with tension sleeve
Insulating material group	I
Rated surge voltage (III/3)	6 kV
Rated surge voltage (III/2)	6 kV
Rated surge voltage (II/2)	6 kV
Rated voltage (III/3)	400 V
Rated voltage (III/2)	630 V
Rated voltage (II/2)	1000 V
Connection in acc. with standard	EN-VDE
Nominal current I_N	20 A
Nominal cross section	4 mm ²
Maximum load current	20 A
Insulating material	PA
Flammability rating according to UL 94	V0
Internal cylindrical gage	A4
Stripping length	7 mm
Screw thread	M3
Tightening torque, min	0.5 Nm
Tightening torque max	0.6 Nm

Connection data

Conductor cross section solid min.	0.2 mm ²
Conductor cross section solid max.	4 mm ²
Conductor cross section flexible min.	0.2 mm ²
Conductor cross section flexible max.	4 mm ²
Conductor cross section flexible, with ferrule without plastic sleeve min.	0.25 mm ²
Conductor cross section flexible, with ferrule without plastic sleeve max.	4 mm ²
Conductor cross section flexible, with ferrule with plastic sleeve min.	0.25 mm ²
Conductor cross section flexible, with ferrule with plastic sleeve max.	4 mm ²
Conductor cross section AWG min.	24
Conductor cross section AWG max.	10
2 conductors with same cross section, solid min.	0.2 mm ²
2 conductors with same cross section, solid max.	2.5 mm ²
2 conductors with same cross section, stranded min.	0.2 mm ²
2 conductors with same cross section, stranded max.	1.5 mm ²
2 conductors with same cross section, stranded, ferrules without plastic sleeve, min.	0.25 mm ²
2 conductors with same cross section, stranded, ferrules without plastic sleeve, max.	1.5 mm ²
2 conductors with same cross section, stranded, TWIN ferrules with plastic sleeve, min.	0.5 mm ²

Printed-circuit board connector - PC 4/ 6-ST-7,62 - 1804946

Technical data

Connection data

2 conductors with same cross section, stranded, TWIN ferrules with plastic sleeve, max.	2.5 mm ²
Minimum AWG according to UL/CUL	30
Maximum AWG according to UL/CUL	10

Standards and Regulations

Connection in acc. with standard	EN-VDE
	CSA
Flammability rating according to UL 94	V0

Environmental Product Compliance

	Lead 7439-92-1
China RoHS	Environmentally Friendly Use Period = 50
	For details about hazardous substances go to tab "Downloads", Category "Manufacturer's declaration"

Drawings

Diagram

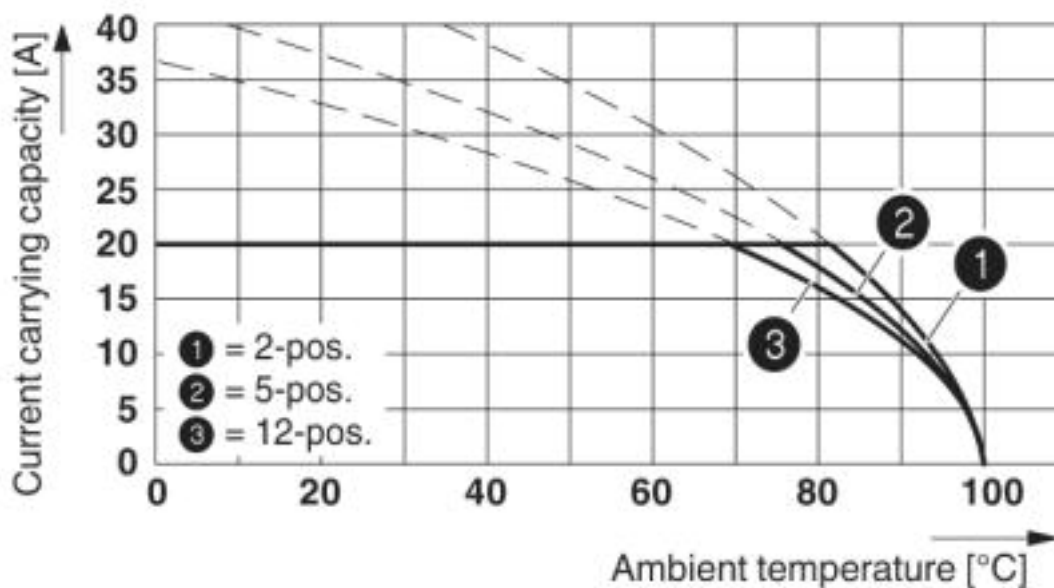

Derating curve for: PC 4/...-ST-7,62 with PC 4/...-G-7,62

Printed-circuit board connector - PC 4/ 6-ST-7,62 - 1804946

Diagram

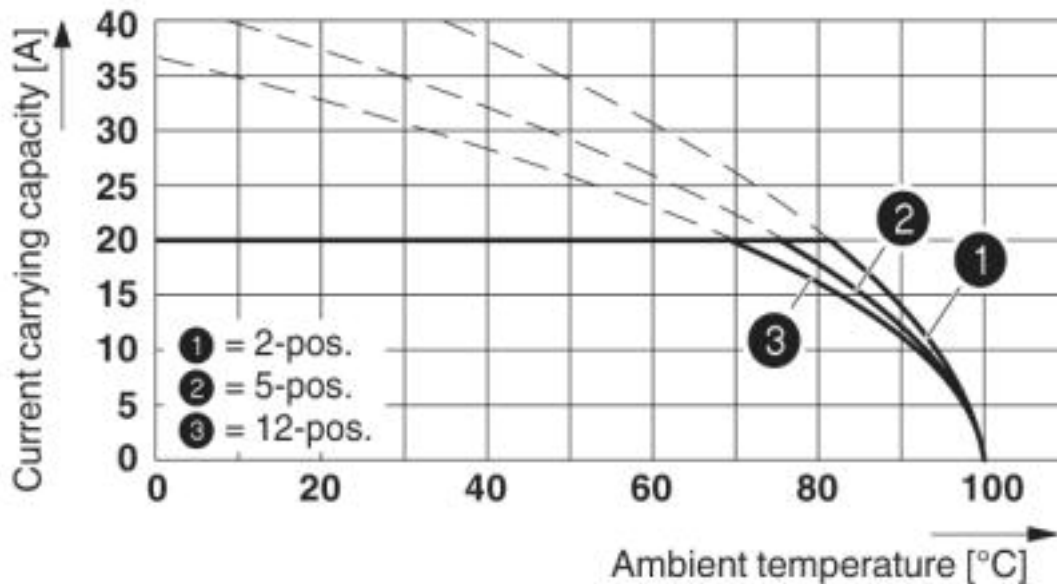

Derating curve for: PC 4/...-ST-7,62 with PCV 4/...-G-7,62

Dimensional drawing

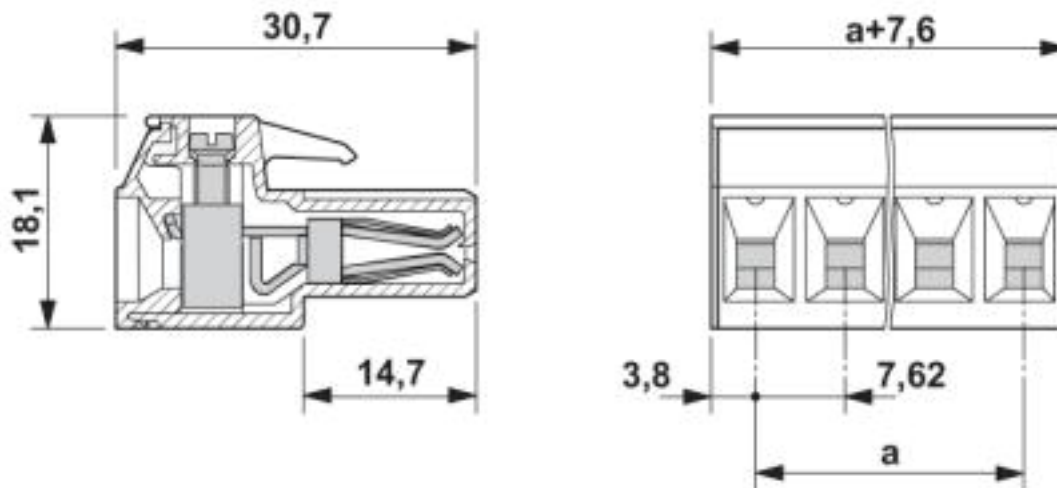

Classifications

eCl@ss

eCl@ss 4.0	27260700
eCl@ss 4.1	27260700
eCl@ss 5.0	27260700
eCl@ss 5.1	27260700
eCl@ss 6.0	27260700
eCl@ss 7.0	27440309

<https://www.phoenixcontact.com/gb/products/1804946>



Printed-circuit board connector - PC 4/ 6-ST-7,62 - 1804946

Classifications

eCl@ss

eCl@ss 8.0	27440309
eCl@ss 9.0	27440309

ETIM

ETIM 3.0	EC001121
ETIM 4.0	EC002638
ETIM 5.0	EC002638
ETIM 6.0	EC002638
ETIM 7.0	EC002638

UNSPSC

UNSPSC 6.01	30211810
UNSPSC 7.0901	39121409
UNSPSC 11	39121409
UNSPSC 12.01	39121409
UNSPSC 13.2	39121409

Approvals

Approvals

Approvals

CSA / RS / BV / EAC / cULus Recognized

Ex Approvals

Approval details

CSA		http://www.csagroup.org/services-industries/product-listing/	13631
	B	C	
Nominal voltage UN	300 V	300 V	
Nominal current IN	20 A	20 A	
mm ² /AWG/kcmil	28-10	28-10	

RS		http://www.rs-head.spb.ru/en/index.php	17.00014.272
----	-------------------------------------------------------------------------------------	---------------------------------------------------------------------------------------------	--------------

<https://www.phoenixcontact.com/gb/products/1804946>



Printed-circuit board connector - PC 4/ 6-ST-7,62 - 1804946

Approvals

BV		http://www.veristar.com/portal/veristarinfo/generalinfo/approved/approvedProducts/equipmentAndMaterials	35433/B0 BV
----	-----------------------------------------------------------------------------------	-------------------------------------------------------------------------------------------------------------------------------------------------------------------------------------------------------------------------------	-------------

EAC			B.01742
-----	-----------------------------------------------------------------------------------	--	---------

cULus Recognized		http://database.ul.com/cgi-bin/XYV/template/LISEXT/1FRAME/index.htm	E60425-19920722
	B	C	D
Nominal voltage UN	300 V	300 V	600 V
Nominal current IN	30 A	30 A	5 A
mm ² /AWG/kcmil	30-10	30-10	30-10

Phoenix Contact 2019 © - all rights reserved
<http://www.phoenixcontact.com>



SCATTERGOOD & JOHNSON LTD

ELECTRICAL ENGINEERING & FLUID CONTROL DISTRIBUTORS

Est.1899

At Scattergood & Johnson Ltd, we pride ourselves on being a technical distributor to specialist industries.

Working with a range of quality product suppliers across a number of specialist markets, we are not your average 'box shifter' - we are your technical and supply chain partner.

We fully support every product we sell - for free! Our internal team and external sales engineers can answer any product or application question, no matter the complexity.

Backing up this technical ability is a range of 50,000+ products available from stock for nationwide next day delivery (same day if required!), or you can collect what you need from any of our trade counters around the UK.

Select your specialist interest below to learn more about how we can help.



Online, In Branch and On the Road - Scattergood & Johnson Ltd, there when you need us.

www.scatts.co.uk