

Accessories - IC-DFR 9 - 1852095

Please be informed that the data shown in this PDF Document is generated from our Online Catalog. Please find the complete data in the user's documentation. Our General Terms of Use for Downloads are valid (<http://phoenixcontact.com/download>)



Panel mounting frame, number of positions: 9, pitch: 5.08 mm, color: green, This assembly frame can only be used in combination with IC 2,5/...-STGF-5,08

Your advantages

- Feed-through assembly frame for inverted COMBICON connector IC 2,5/-STGF-5,08
- Cable connection on the inside of the device enables flexible positioning of the panel feed-through
- Mounting flanges reduce the mechanical strain on the soldering spots
- Can be combined with the MSTB 2,5 range



Key Commercial Data

Packing unit	50 pc
Minimum order quantity	50 pc
GTIN	 4 017918 108977
GTIN	4017918108977
Weight per Piece (excluding packing)	2.600 g
Custom tariff number	39269097
Country of origin	Poland

Technical data

Dimensions

Length	19 mm
Height	16.75 mm
Width	69.39 mm
Pitch	5.08 mm
Dimension a	47.54 mm

General

Range of articles	IC-DFR
Insulating material group	I

Accessories - IC-DFR 9 - 1852095

Technical data

General

Nominal cross section	2.5 mm ²
Insulating material	PA
Flammability rating according to UL 94	V0
Number of positions	9

Standards and Regulations

Flammability rating according to UL 94	V0
--	----

Environmental Product Compliance

China RoHS	Environmentally friendly use period: unlimited = EFUP-e
	No hazardous substances above threshold values

Drawings

Drilling diagram

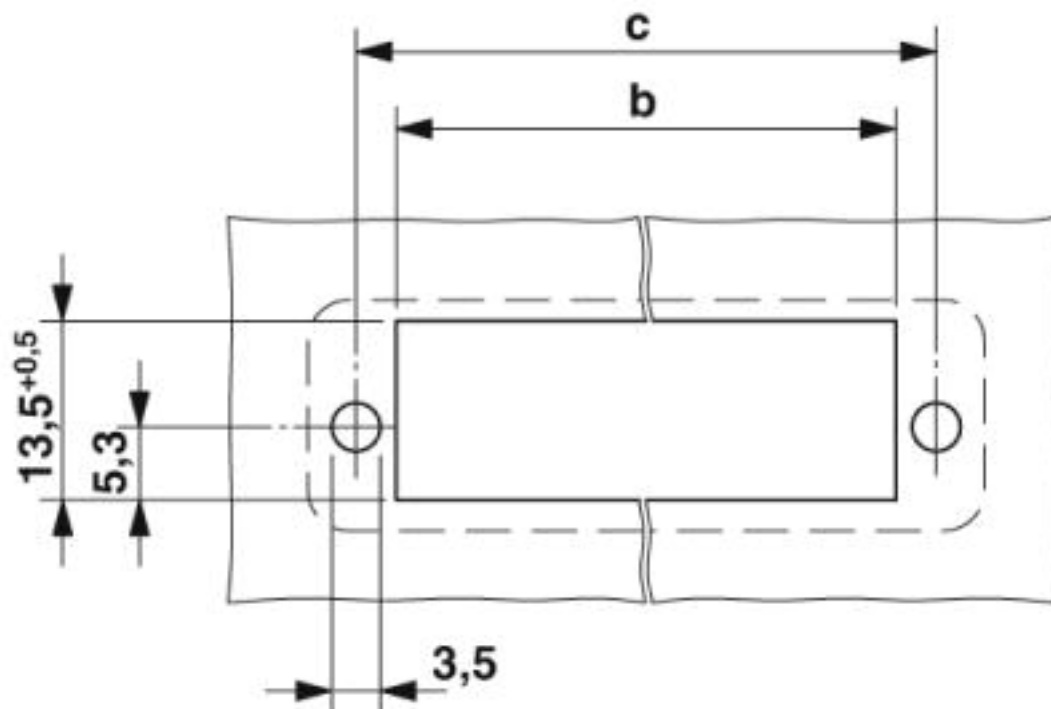

Dimension b: 10.84 mm + (no. of pos. x 5.08 mm)
 Dimension c: Dim. b + 5.83 mm

Accessories - IC-DFR 9 - 1852095

Dimensional drawing

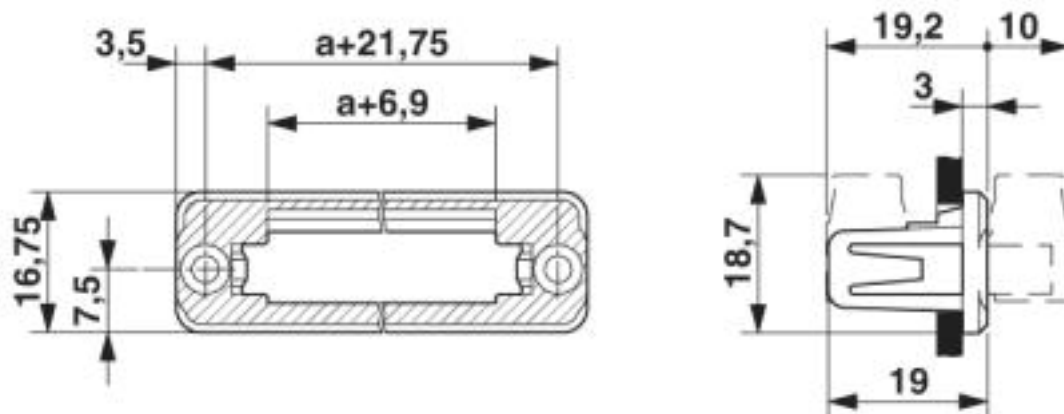

Classifications

eCl@ss

eCl@ss 4.0	27260700
eCl@ss 4.1	27260700
eCl@ss 5.0	27260700
eCl@ss 5.1	27260700
eCl@ss 6.0	27261200
eCl@ss 7.0	27440210
eCl@ss 8.0	27440210
eCl@ss 9.0	27440210

ETIM

ETIM 3.0	EC000879
ETIM 4.0	EC000879
ETIM 5.0	EC002310
ETIM 6.0	EC002310
ETIM 7.0	EC002310

UNSPSC

UNSPSC 6.01	30211810
UNSPSC 7.0901	39121409
UNSPSC 11	39121409
UNSPSC 12.01	39121409
UNSPSC 13.2	39121421

Approvals

Approvals

<https://www.phoenixcontact.com/gb/products/1852095>



Accessories - IC-DFR 9 - 1852095

Approvals

Approvals

EAC

Ex Approvals

Approval details

EAC		B.01742
-----	---	---------

Phoenix Contact 2019 © - all rights reserved
<http://www.phoenixcontact.com>



SCATTERGOOD & JOHNSON LTD

ELECTRICAL ENGINEERING & FLUID CONTROL DISTRIBUTORS

Est.1899

At Scattergood & Johnson Ltd, we pride ourselves on being a technical distributor to specialist industries.

Working with a range of quality product suppliers across a number of specialist markets, we are not your average 'box shifter' - we are your technical and supply chain partner.

We fully support every product we sell - for free! Our internal team and external sales engineers can answer any product or application question, no matter the complexity.

Backing up this technical ability is a range of 50,000+ products available from stock for nationwide next day delivery (same day if required!), or you can collect what you need from any of our trade counters around the UK.

Select your specialist interest below to learn more about how we can help.



Online, In Branch and On the Road - Scattergood & Johnson Ltd, there when you need us.

www.scatts.co.uk