

<https://www.phoenixcontact.com/gb/products/2770888>



## Double-level terminal block - UKK 3-MSTB-5,08 - 2770888

Please be informed that the data shown in this PDF Document is generated from our Online Catalog. Please find the complete data in the user's documentation. Our General Terms of Use for Downloads are valid (<http://phoenixcontact.com/download>)



Double-level modular terminal block with COMBICON plug-in zone, nominal current: 12 A, nominal voltage: 250 V, cross section: 0.2 mm<sup>2</sup> - 4 mm<sup>2</sup>, AWG: 24 - 12, mounting type: NS 35/7.5, NS 35/15, NS 32, pitch: 5.08 mm, width: 5.08, color: gray

RoHS

### Key Commercial Data

Packing unit	50 pc
GTIN	 4 017918 068110
GTIN	4017918068110
Weight per Piece (excluding packing)	8.180 g
Custom tariff number	85369010
Country of origin	Turkey

### Technical data

#### General

Number of levels	2
Number of connections	4
Color	gray
Insulating material	PA
Flammability rating according to UL 94	V2
Rated surge voltage	4 kV
Degree of pollution	3
Overvoltage category	III
Insulating material group	I
Nominal current $I_N$	10 A
Maximum load current	12 A (with 4 mm <sup>2</sup> conductor cross section)
Nominal voltage $U_N$	250 V
Open side panel	Yes
Number of positions	1

<https://www.phoenixcontact.com/gb/products/2770888>



## Double-level terminal block - UKK 3-MSTB-5,08 - 2770888

### Technical data

#### Connection data

Connection labeling	1st and 2nd level connection left
Conductor cross section solid min.	0.2 mm <sup>2</sup>
Conductor cross section solid max.	4 mm <sup>2</sup>
Conductor cross section flexible min.	0.2 mm <sup>2</sup>
Conductor cross section flexible max.	2.5 mm <sup>2</sup>
Conductor cross section AWG min.	24
Conductor cross section AWG max.	12
Conductor cross section flexible, with ferrule without plastic sleeve min.	0.25 mm <sup>2</sup>
Conductor cross section flexible, with ferrule without plastic sleeve max.	2.5 mm <sup>2</sup>
Conductor cross section flexible, with ferrule with plastic sleeve min.	0.25 mm <sup>2</sup>
Conductor cross section flexible, with ferrule with plastic sleeve max.	1.5 mm <sup>2</sup>
2 conductors with same cross section, solid min.	0.2 mm <sup>2</sup>
2 conductors with same cross section, solid max.	1.5 mm <sup>2</sup>
2 conductors with same cross section, stranded min.	0.2 mm <sup>2</sup>
2 conductors with same cross section, stranded max.	1 mm <sup>2</sup>
2 conductors with same cross section, stranded, ferrules without plastic sleeve, min.	0.25 mm <sup>2</sup>
2 conductors with same cross section, stranded, ferrules without plastic sleeve, max.	0.5 mm <sup>2</sup>
2 conductors with same cross section, stranded, TWIN ferrules with plastic sleeve, min.	0.5 mm <sup>2</sup>
2 conductors with same cross section, stranded, TWIN ferrules with plastic sleeve, max.	1 mm <sup>2</sup>
Connection method	Screw connection
Stripping length	8 mm
Internal cylindrical gage	A3
Screw thread	M3
Tightening torque, min	0.5 Nm
Tightening torque max	0.6 Nm

#### Standards and Regulations

Connection in acc. with standard	CSA
Flammability rating according to UL 94	V2

#### Environmental Product Compliance

	Lead 7439-92-1
China RoHS	Environmentally Friendly Use Period = 50
	For details about hazardous substances go to tab "Downloads", Category "Manufacturer's declaration"

### Drawings

## Double-level terminal block - UKK 3-MSTB-5,08 - 2770888

Dimensional drawing

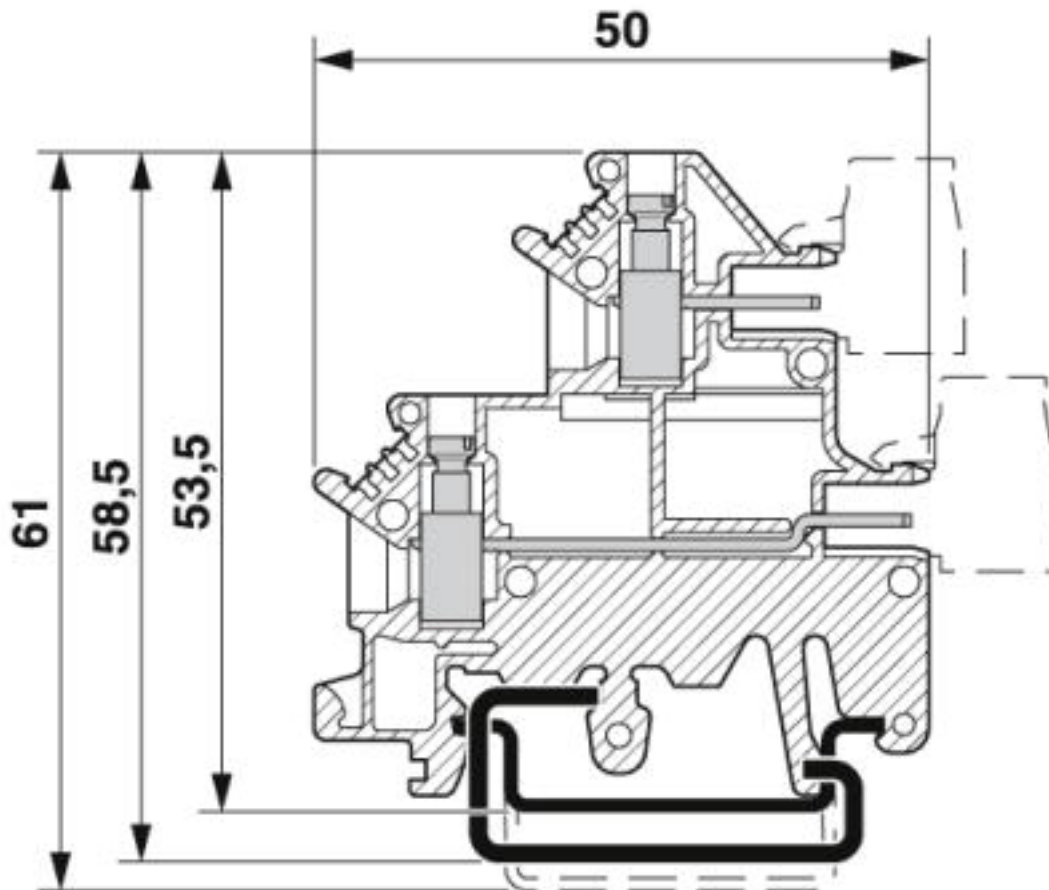

### Classifications

#### eCl@ss

eCl@ss 4.0	27141100
eCl@ss 4.1	27141100
eCl@ss 5.0	27141100
eCl@ss 5.1	27141100
eCl@ss 6.0	27141100
eCl@ss 7.0	27141120
eCl@ss 8.0	27141120
eCl@ss 9.0	27141120

#### ETIM

ETIM 2.0	EC000897
ETIM 3.0	EC000897
ETIM 4.0	EC000897
ETIM 5.0	EC000897
ETIM 6.0	EC000897

<https://www.phoenixcontact.com/gb/products/2770888>



## Double-level terminal block - UKK 3-MSTB-5,08 - 2770888

### Classifications

#### ETIM

ETIM 7.0	EC000897
----------	----------

#### UNSPSC

UNSPSC 6.01	30211811
UNSPSC 7.0901	39121410
UNSPSC 11	39121410
UNSPSC 12.01	39121410
UNSPSC 13.2	39121410

### Approvals

#### Approvals

#### Approvals

CSA / UL Recognized / cUL Recognized / IECCE CB Scheme / VDE Gutachten mit Fertigungsüberwachung / EAC / cULus Recognized

#### Ex Approvals

#### Approval details

CSA		<a href="http://www.csagroup.org/services-industries/product-listing/">http://www.csagroup.org/services-industries/product-listing/</a>	13631
Nominal voltage UN		300 V	
Nominal current IN		10 A	
mm <sup>2</sup> /AWG/kcmil		28-12	

UL Recognized		<a href="http://database.ul.com/cgi-bin/XYV/template/LISEXT/1FRAME/index.htm">http://database.ul.com/cgi-bin/XYV/template/LISEXT/1FRAME/index.htm</a>	FILE E 60425
	B	D	
Nominal voltage UN	300 V	300 V	
Nominal current IN	10 A	10 A	
mm <sup>2</sup> /AWG/kcmil	30-12	30-12	

<https://www.phoenixcontact.com/gb/products/2770888>



## Double-level terminal block - UKK 3-MSTB-5,08 - 2770888

### Approvals

cUL Recognized		<a href="http://database.ul.com/cgi-bin/XYV/template/LISEXT/1FRAME/index.htm">http://database.ul.com/cgi-bin/XYV/template/LISEXT/1FRAME/index.htm</a>	FILE E 60425
	B	D	
Nominal voltage UN	300 V	300 V	
Nominal current IN	10 A	10 A	
mm <sup>2</sup> /AWG/kcmil	30-12	30-12	

IECEE CB Scheme		<a href="http://www.iecee.org/">http://www.iecee.org/</a>	DE1-60988-B1B2
Nominal voltage UN	250 V		
Nominal current IN	12 A		
mm <sup>2</sup> /AWG/kcmil	0.2-4		

VDE Gutachten mit Fertigungsüberwachung		<a href="http://www2.vde.com/de/Institut/Online-Service/VDE-gepruefteProdukte/Seiten/Online-Suche.aspx">http://www2.vde.com/de/Institut/Online-Service/ VDE-gepruefteProdukte/Seiten/Online-Suche.aspx</a>	40047172
Nominal voltage UN	250 V		
Nominal current IN	12 A		
mm <sup>2</sup> /AWG/kcmil	0.2-2.5		

EAC		RU C- DE.A*30.B.01742
-----	---	--------------------------

cULus Recognized	
------------------	---

Phoenix Contact 2019 © - all rights reserved  
<http://www.phoenixcontact.com>



# SCATTERGOOD & JOHNSON LTD

ELECTRICAL ENGINEERING & FLUID CONTROL DISTRIBUTORS

Est.1899

At Scattergood & Johnson Ltd, we pride ourselves on being a technical distributor to specialist industries.

Working with a range of quality product suppliers across a number of specialist markets, we are not your average 'box shifter' - we are your technical and supply chain partner.

We fully support every product we sell - for free! Our internal team and external sales engineers can answer any product or application question, no matter the complexity.

Backing up this technical ability is a range of 50,000+ products available from stock for nationwide next day delivery (same day if required!), or you can collect what you need from any of our trade counters around the UK.

Select your specialist interest below to learn more about how we can help.



Online, In Branch and On the Road - Scattergood & Johnson Ltd, there when you need us.

# [www.scatts.co.uk](http://www.scatts.co.uk)