

PCB bottom side
PCB top side

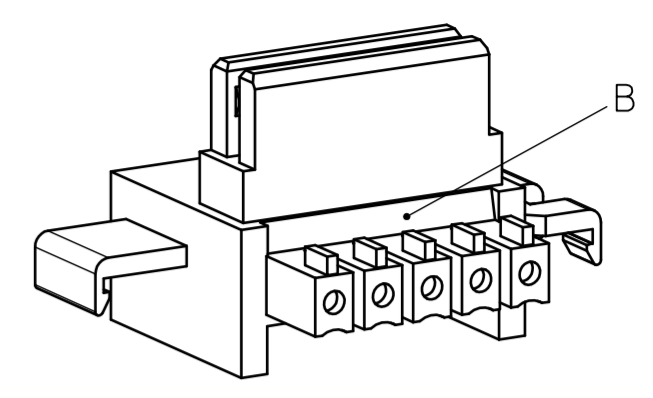
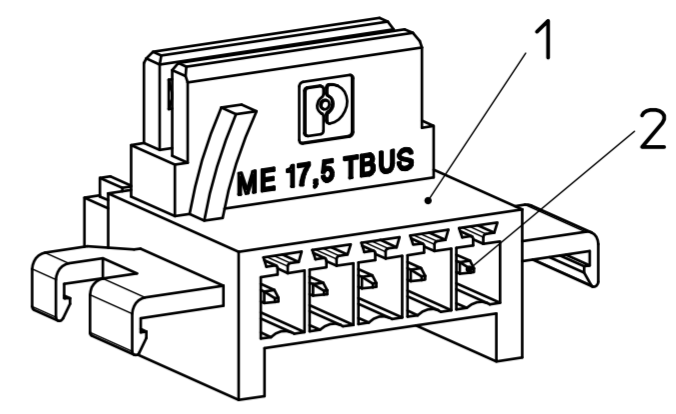
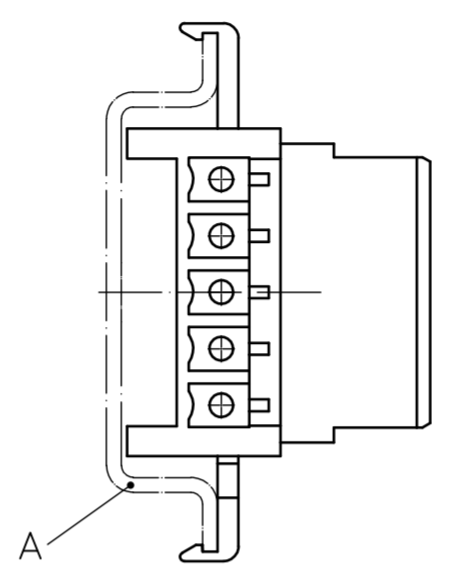
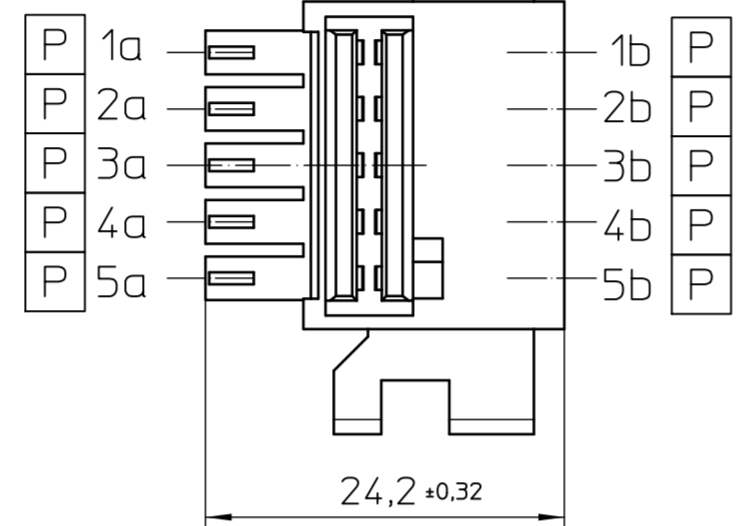
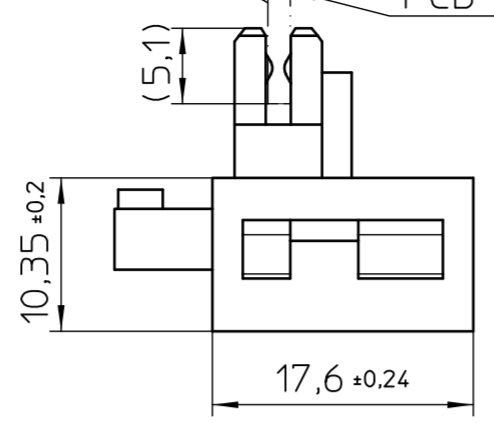

Wiring Diagram

schematic symbol	circuit type	circuit symbol
	parallel	

recommended PCB

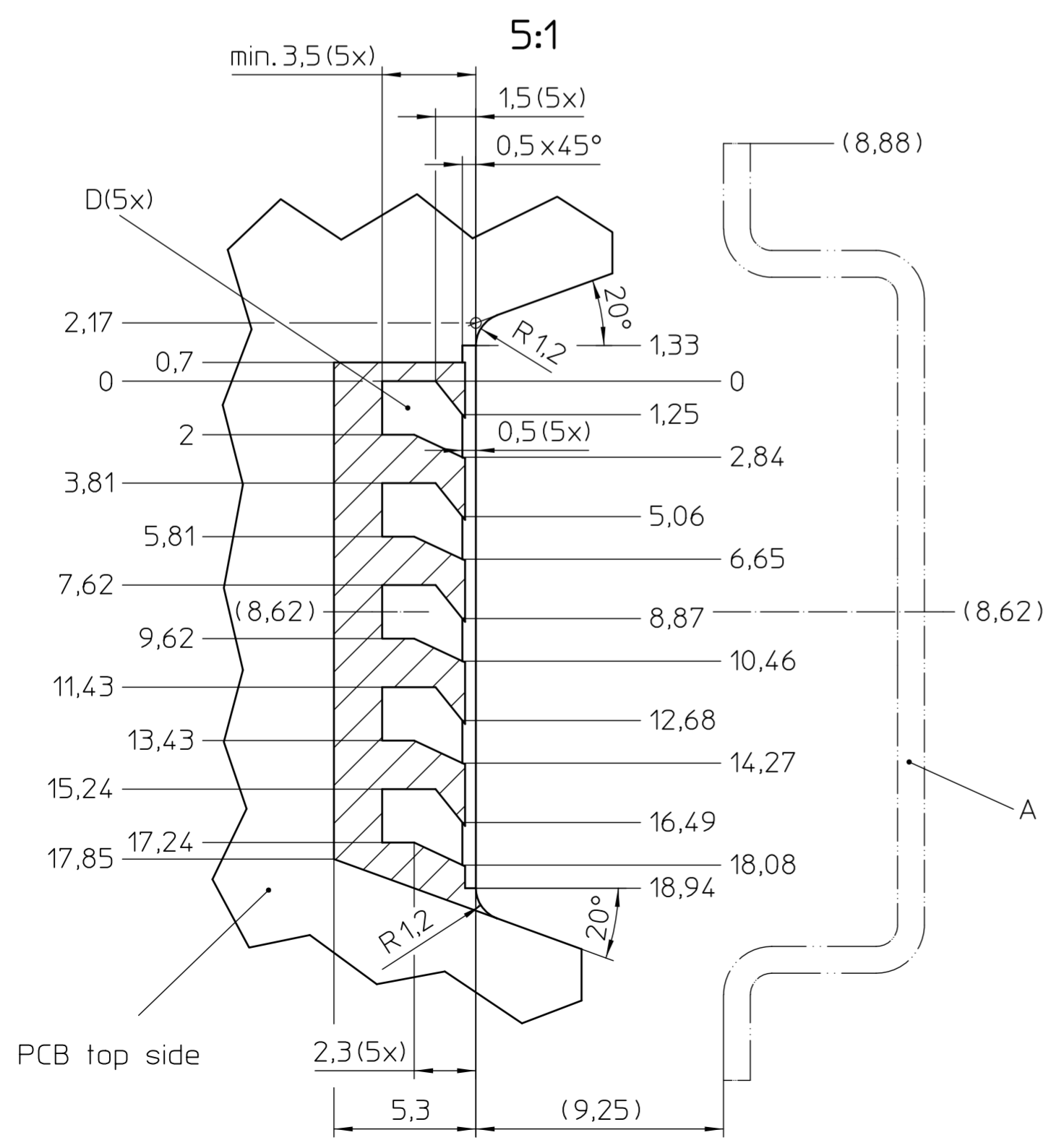

pad numbering

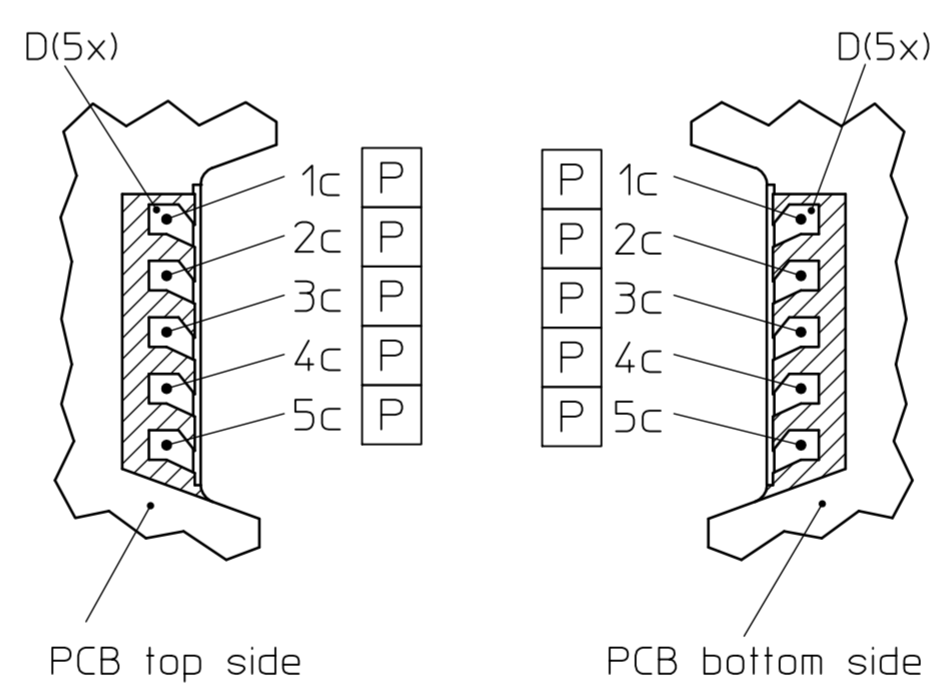

General tolerances PCB:
 dimensions ≤ 30: ±0,1/R±0,2/±1°
 dimensions > 30: ±0,15/R±0,2/±1°
 symmetry: 0,2

General Information:

- Simplified representation
- Document excluded from change process
- Linear dimensions [mm]
- Tolerances apply in a normal climate according to DIN EN ISO 291-23/50-2, PA plastic parts with about 2% (% by weight) moisture content.
- Web: www.phoenixcontact.com
- Restricted area, no components

Additional Information:

- A) Mounting rail like EN 6075: TH 35-7,5 or mounting rail TH 35-15x1,5 similar to EN 60715
- B) Disassembly notch to separate BUS modules with screwdriver.
- C) PCB t=1,6/+0,2
- D) ME...TBUS... contact pad's, surface: Ni 2-10µm / Au (hardgold) 0,8-1,4µm

Pos.	QTY	Description	Material
1	1	HOUSING	PA
2	5	CONTACT	Cu alloy, Au plated

	DIN A2	document-No. / RI	00899952 / 03	date	20.12.2017	scale	2:1
	ident.-No.	document-type	2709561	TECDOC 2D_Productdrawing			
page 1	of 1	description	ME 17,5 TBUS 1,5/ 5-ST-3,81 GN				

Transfer or duplication of this document as well as the utilisation or communication of its content are not permitted unless express consent is granted. Violations give rise to claims for damages. All rights reserved in case of patent, utility model or design patent registrations.

Weitergabe sowie Vervielfältigung dieses Dokuments, Verwertung und Mitteilung seines Inhalts sind verboten, soweit nicht ausdrücklich gestattet. Zuwiderhandlungen verpflichten zu Schadensersatz. Alle Rechte für den Fall der Patent-, Gebrauchsmuster- oder Designeintragung vorbehalten.



SCATTERGOOD & JOHNSON LTD

ELECTRICAL ENGINEERING & FLUID CONTROL DISTRIBUTORS

Est.1899

At Scattergood & Johnson Ltd, we pride ourselves on being a technical distributor to specialist industries.

Working with a range of quality product suppliers across a number of specialist markets, we are not your average 'box shifter' - we are your technical and supply chain partner.

We fully support every product we sell - for free! Our internal team and external sales engineers can answer any product or application question, no matter the complexity.

Backing up this technical ability is a range of 50,000+ products available from stock for nationwide next day delivery (same day if required!), or you can collect what you need from any of our trade counters around the UK.

Select your specialist interest below to learn more about how we can help.



Online, In Branch and On the Road - Scattergood & Johnson Ltd, there when you need us.

www.scatts.co.uk