

Bus coupler - AXL F BK EC - 2688899

Please be informed that the data shown in this PDF Document is generated from our Online Catalog. Please find the complete data in the user's documentation. Our General Terms of Use for Downloads are valid (<http://phoenixcontact.com/download>)



Axioline F, Bus coupler, EtherCAT[®], RJ45 socket, transmission speed in the local bus: 100 Mbps, degree of protection: IP20, including bus base module and Axioline F connector

Product Description

The bus coupler is intended for use within an EtherCAT[®] network and represents the link to the Axioline F I/O system. Up to 63 Axioline F devices can be connected to the bus coupler.

EtherCAT[®] is a registered trademark and patented technology, licensed by Beckhoff Automation GmbH, Germany.

A corresponding ESI file is available for integrating the Axioline F station into the programming system.

It can be downloaded at: phoenixcontact.net/product/2688899

Your advantages

- 2 RJ45 connections
- Rotary encoding switch
- Automatic addressing
- Station mapped as a modular EtherCAT[®] device using a modular device profile (MDP)
- Station can be mapped as a block device
- Acyclic data communication (mailbox protocols)
- Cyclic data communication
- Firmware can be updated
- Typical cycle time of the Axioline F local bus is around 10 µs



Key Commercial Data

Packing unit	1 pc
GTIN	 4 046356 658355
GTIN	4046356658355
Weight per Piece (excluding packing)	219.900 g
Custom tariff number	85176200
Country of origin	Germany

Technical data

Dimensions

Bus coupler - AXL F BK EC - 2688899

Technical data

Dimensions

Width	45 mm
Height	126.1 mm
Depth	74 mm
Note on dimensions	The depth is valid when a TH 35-7,5 DIN rail is used (according to EN 60715).

Ambient conditions

Ambient temperature (operation)	-25 °C ... 60 °C (Mounting position: wall mounting on horizontal DIN rail)
	-25 °C ... 55 °C (Mounting position: any)
Ambient temperature (storage/transport)	-40 °C ... 85 °C
Permissible humidity (operation)	5 % ... 95 % (non-condensing)
Permissible humidity (storage/transport)	5 % ... 95 % (non-condensing)
Air pressure (operation)	70 kPa ... 106 kPa (up to 3000 m above sea level)
Air pressure (storage/transport)	70 kPa ... 106 kPa (up to 3000 m above sea level)
Degree of protection	IP20

Connection data

Designation	Axioline F connector
Connection method	Push-in connection
Note on the connection method	Please observe the information provided on conductor cross sections in the "Axioline F: system and installation" user manual.
Conductor cross section solid min.	0.2 mm ²
Conductor cross section solid max.	1.5 mm ²
Conductor cross section flexible min.	0.2 mm ²
Conductor cross section flexible max.	1.5 mm ²
Conductor cross section AWG min.	24
Conductor cross section AWG max.	16
Stripping length	8 mm

General

Mounting type	DIN rail
Color	traffic grey A RAL 7042
Net weight	219.9 g
Note on weight specifications	with connector and bus base module
Diagnostics messages	Emergency messages
	Messages via object 10F3 _{hex} Diagnosis history
Mounting position	any (observe temperature derating)

Interfaces

Designation	EtherCAT [®]
No. of channels	2
Connection method	RJ45 socket
Note on the connection method	Auto negotiation and autocrossing

Bus coupler - AXL F BK EC - 2688899

Technical data

Interfaces

Transmission speed	100 Mbps (full duplex)
Transmission physics	Ethernet in RJ45 twisted pair
Designation	Axioline F local bus
Connection method	Bus base module
Transmission speed	100 Mbps
Designation	Service
Connection method	Micro USB type B

System limits of the bus coupler

Amount of process data	1024 Byte (for each data direction)
Number of supported devices	max. 63 (per station)
Number of local bus devices that can be connected	max. 63
Designation	EtherCAT [®]
System-specific protocols	Mailbox protocols CAN application protocol over EtherCAT [®]
	Mailbox protocols File access over EtherCAT [®]
Type of addressing	Auto-increment addressing
	Fixed position addressing
	Logical addressing
	Explicit device ID
Specification	ETG.1000 V1.02

Axioline potentials

Designation	Communications power U_L feed-in (the supply of the Axioline F local bus U_{BUS} is generated from U_L)
Supply voltage	24 V DC
Supply voltage range	19.2 V DC ... 30 V DC (including all tolerances, including ripple)
Current consumption	max. 570 mA (with 2 A at U_{BUS} for the I/Os and $U_L = 24$ V)
Power consumption	max. 13.7 W (with 2 A load at U_{BUS} for the I/Os)
Designation	Axioline F local bus supply (U_{BUS})
Supply voltage	5 V DC (via bus base module)
Power supply unit	2 A
Protective circuit	Surge protection of the supply voltage electronic
	Polarity reversal protection of the supply voltage electronic

Standards and Regulations

Mechanical tests	Vibration resistance in acc. with EN 60068-2-6/IEC 60068-2-6 5g
	Shock in acc. with EN 60068-2-27/IEC 60068-2-27 30g
	Continuous shock according to EN 60068-2-27/IEC 60068-2-27 10g
Protection class	III (IEC 61140, EN 61140, VDE 0140-1)

Environmental Product Compliance

	Lead 7439-92-1
China RoHS	Environmentally Friendly Use Period = 50

Bus coupler - AXL F BK EC - 2688899

Technical data

Environmental Product Compliance

	For details about hazardous substances go to tab "Downloads", Category "Manufacturer's declaration"
--	---

Drawings

Connection diagram

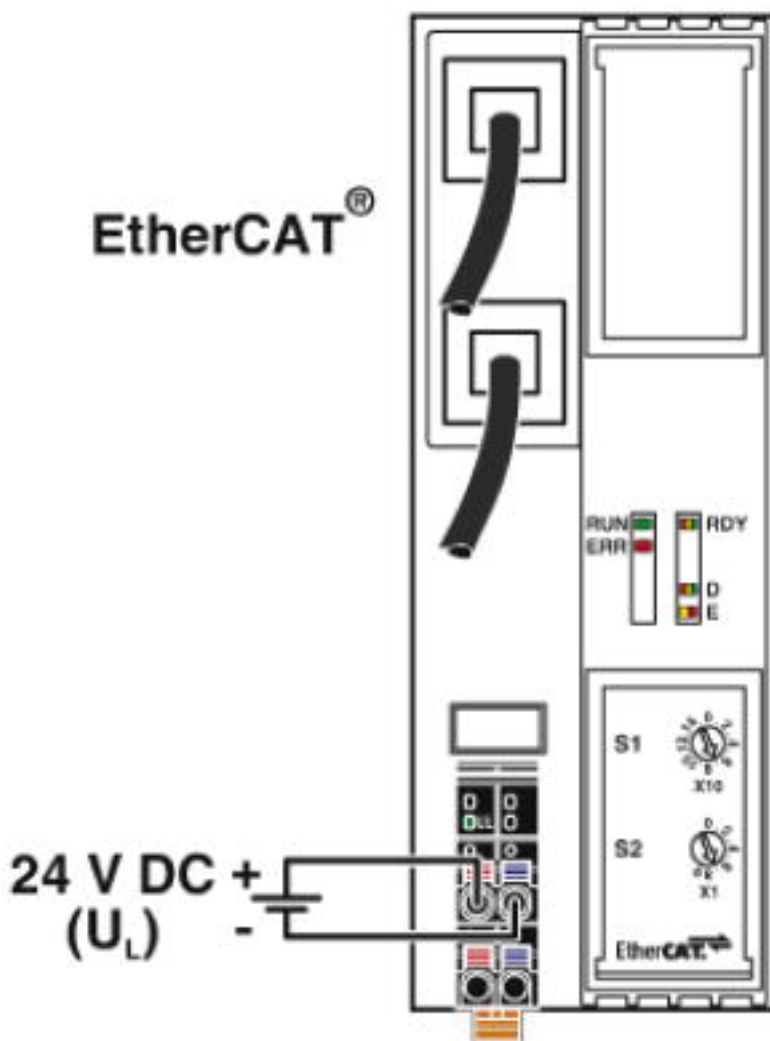

Bus coupler - AXL F BK EC - 2688899

Block diagram

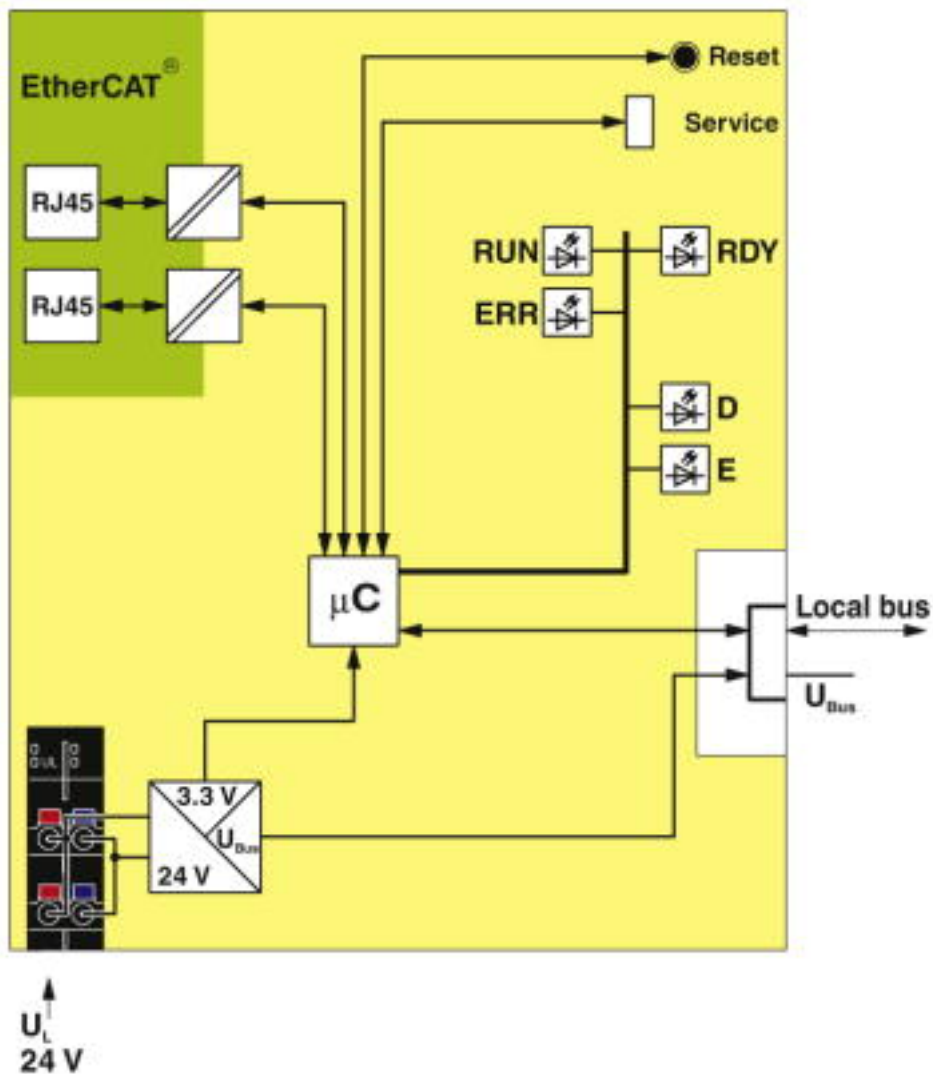

Internal wiring of the terminal points

Bus coupler - AXL F BK EC - 2688899

Dimensional drawing

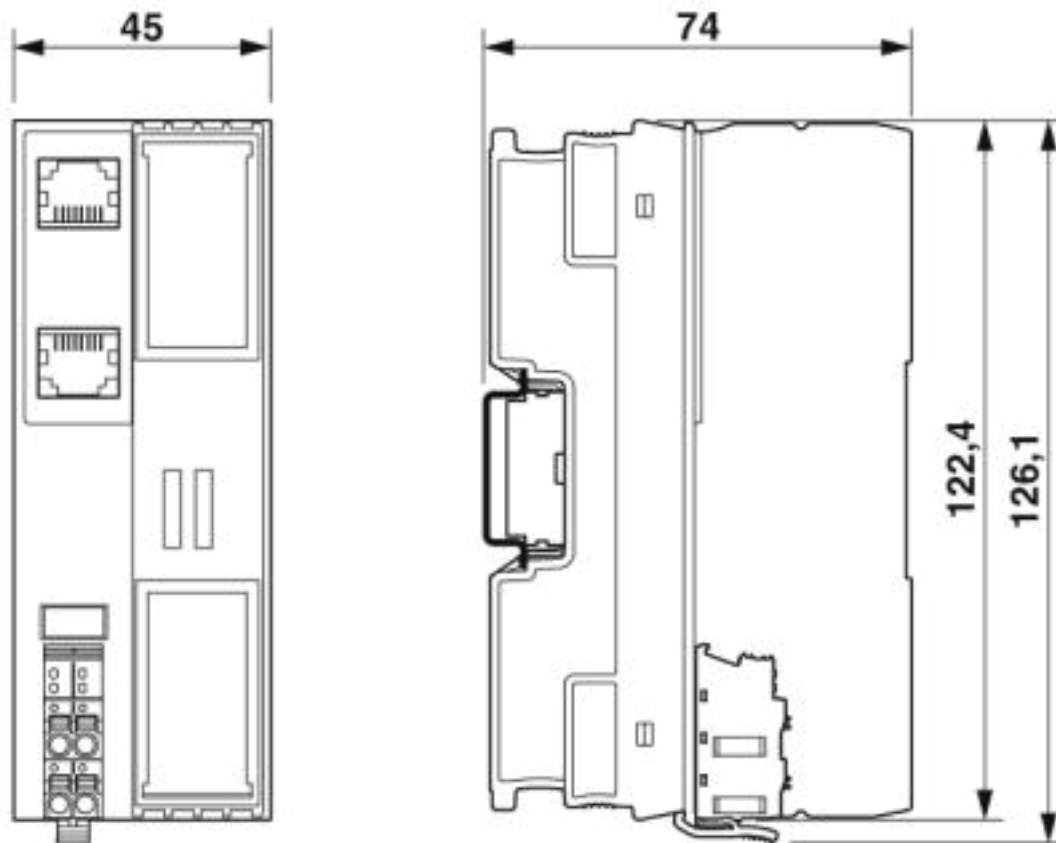

Classifications

eCl@ss

eCl@ss 4.0	27240400
eCl@ss 4.1	27240400
eCl@ss 5.0	27242200
eCl@ss 5.1	27242600
eCl@ss 6.0	27242600
eCl@ss 7.0	27242608
eCl@ss 8.0	27242608
eCl@ss 9.0	27242608

ETIM

ETIM 3.0	EC001604
ETIM 4.0	EC001604
ETIM 5.0	EC001604
ETIM 6.0	EC001604
ETIM 7.0	EC001604

<https://www.phoenixcontact.com/gb/products/2688899>



Bus coupler - AXL F BK EC - 2688899

Classifications

UNSPSC

UNSPSC 6.01	43172015
UNSPSC 7.0901	43201404
UNSPSC 11	39121311
UNSPSC 12.01	39121311
UNSPSC 13.2	32151602

Approvals





Approvals

Approvals

DNV GL / KR / NK / ABS / BSH / RINA / UL Listed / cUL Listed / EtherCAT / LR / PRS / BV / cULus Listed

Ex Approvals

Approval details







DNV GL		https://approvalfinder.dnvgl.com/	TAA00000DF
KR		http://www.krs.co.kr/eng/main/main.aspx	HMB17372-AC002
NK		http://www.classnk.or.jp/hp/en/	14A006
ABS		http://www.eagle.org/eagleExternalPortalWEB/	18-HG1767360-PDA
BSH		http://www.bsh.de/de/index.jsp	840
RINA		http://www.rina.org/en	ELE256518XG
UL Listed		http://database.ul.com/cgi-bin/XYV/template/LISEXT/1FRAME/index.htm	FILE E 238705

<https://www.phoenixcontact.com/gb/products/2688899>



Bus coupler - AXL F BK EC - 2688899

Approvals

cUL Listed		http://database.ul.com/cgi-bin/XYV/template/LISEXT/1FRAME/index.htm	FILE E 238705
EtherCAT			0x290783
LR		http://www.lr.org/en	14-20019
PRS		http://www.prs.pl/	TE/2239/880590/19
BV		http://www.veristar.com/portal/veristarinfo/generalinfo/approved/approvedProducts/equipmentAndMaterials	36433/B0 BV
cULus Listed			

Phoenix Contact 2019 © - all rights reserved
<http://www.phoenixcontact.com>



SCATTERGOOD & JOHNSON LTD

ELECTRICAL ENGINEERING & FLUID CONTROL DISTRIBUTORS

Est.1899

At Scattergood & Johnson Ltd, we pride ourselves on being a technical distributor to specialist industries.

Working with a range of quality product suppliers across a number of specialist markets, we are not your average 'box shifter' - we are your technical and supply chain partner.

We fully support every product we sell - for free! Our internal team and external sales engineers can answer any product or application question, no matter the complexity.

Backing up this technical ability is a range of 50,000+ products available from stock for nationwide next day delivery (same day if required!), or you can collect what you need from any of our trade counters around the UK.

Select your specialist interest below to learn more about how we can help.



Online, In Branch and On the Road - Scattergood & Johnson Ltd, there when you need us.

www.scatts.co.uk