

# AXL E IOL AO1 I M12 S

**Axioline E IO-Link/analog converter  
for connecting an analog actuator,  
4 mA ... 20 mA, straight version**

Data sheet  
8596\_en\_08

© PHOENIX CONTACT 2019-09-24



## 1 Description

The IO-Link/analog converter is an IO-Link device that converts the IO-Link protocol into analog signals.

It therefore offers the option of transmitting signals to analog actuators via an IO-Link master.

### IO-Link features

- Connection to an IO-Link master with M12 connector (A-coded, 4-pin)
- IO-Link A port
- IO-Link specification V1.1.1

### General features

- Straight version
- 1 IO-Link interface
- 1 analog output
- Connection of the actuator in 3-wire technology via an M12 connector (A-coded, 5-pin)
- Current range: 4 mA ... 20 mA
- FE connection for local connection to functional earth ground
- Supply of the module electronics and the actuator via the IO-Link interface of the IO-Link master
- Local status indicator
- Degree of protection IP65/67



Make sure you always use the latest documentation.  
It can be downloaded from the product at [phoenixcontact.net/products](https://www.phoenixcontact.net/products).

<b>2</b>	<b>Table of contents</b>	
1	Description .....	1
2	Table of contents .....	2
3	Ordering data .....	3
4	Technical data .....	3
5	Additional tables .....	5
6	Internal circuit diagram .....	5
7	Pin assignment .....	6
	7.1 Connections on the device .....	6
	7.2 Pin assignment of the IO-Link interface .....	6
	7.3 Pin assignment of the analog output .....	6
8	Connection notes .....	6
9	Connection example.....	6
10	Assembly.....	7
11	Local status indicator.....	7
12	Process data.....	8
	12.1 IN process data .....	8
	12.2 OUT process data.....	8
	12.3 Parameterization via OUT process data .....	9
	12.4 Example .....	9
13	Significant values in various formats.....	10
	13.1 IB IL format .....	10
	13.2 Format S7 compatible.....	10
14	IO-Link objects .....	11
	14.1 Overview of the objects .....	11
	14.2 Parameterization (80 <sub>hex</sub> : ParaWord) .....	11

### 3 Ordering data

Description	Type	Order No.	Pcs./Pkt.
Axioline E-IO-Link/analog converter for connecting an analog actuator, 4 mA ... 20 mA, M12 fast connection technology, straight version	AXL E IOL AO1 I M12 S	2700351	1

### 4 Technical data

#### Dimensions (nominal sizes in mm)

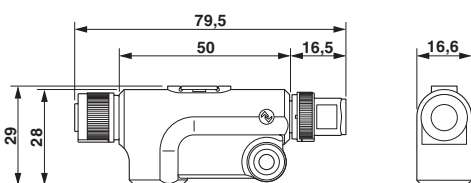

Width	16.6 mm
Height	29 mm
Depth	79.5 mm

#### General data

Weight	34 g
Ambient temperature (operation)	-25 °C ... 60 °C
Ambient temperature (storage/transport)	-25 °C ... 85 °C
Permissible humidity (operation)	5 % ... 95 %
Permissible humidity (storage/transport)	5 % ... 95 %
Air pressure (operation)	70 kPa ... 106 kPa (up to 3000 m above sea level)
Air pressure (storage/transport)	70 kPa ... 106 kPa (up to 3000 m above sea level)
Degree of protection	IP65/67
Protection class	III, IEC 61140, EN 61140, VDE 0140-1
Degree of pollution	2

#### IO-Link

Specification	V1.1.1
Reverse polarity protection	Yes
Transmission speed	230,4 kBit/s (COM3)
Frame type	1
Cycle Time	min. 2 ms
Process data update	2 ms
Amount of process data	16 Bit (Input data), 16 Bit (Output data)

**IO-Link ports**

Number of ports	1
Connection method	M12 connector, A-coded

**IO-Link port supply**

Nominal voltage for I/O supply	24 V DC (This supply voltage is provided via the IO-Link interface of the IO-Link master.)
Sensor supply voltage	24 V DC (This supply voltage is provided via the I/O supply.)
Current consumption	typ. 16.5 mA $\pm$ 15 % (at 24 V DC) max. 135 mA
Nominal current	max. 100 mA
Reverse polarity protection	yes
Short-circuit protection	yes
Overload protection	yes

**Analog output**

Number of outputs	1 (current)
Connection method	M12 connector, A-coded
Connection method	3-conductor
Current output signal	4 mA ... 20 mA
Load/output load current output	max. 500 $\Omega$
D/A resolution	12 bit
Data formats	IB IL, S7-compatible
Permissible cable length	max. 30 m (Shielded cable)

**Error messages to the higher level control or computer system**

Short circuit	Message in the diagnostic code (in the IB IL format)
Configuration invalid	Message in the diagnostic code (in the IB IL format)
Module faulty	Message in the diagnostic code (in the IB IL format)

**Mechanical tests**

Vibration resistance in acc. with EN 60068-2-6/ IEC 60068-2-6	Operation: 2g
Vibration resistance in acc. with EN 60068-2-6/ IEC 60068-2-6	Storage/transport: 5g
Shock in acc. with EN 60068-2-27/IEC 60068-2-27	Operation: 30g, 11 ms, three shocks in each space direction
Shock in acc. with EN 60068-2-27/IEC 60068-2-27	Storage/transport: 50g, 11 ms, three shocks in each space direction
Continuous shock according to EN 60068-2-27/ IEC 60068-2-27	10g, 16 ms, 1000 shocks, in all space directions

**Approvals**

For the latest approvals, please visit [phoenixcontact.net/products](http://phoenixcontact.net/products).

## 5 Additional tables

The data is valid for nominal operation (supply voltage = 24 V) in the default configuration (measuring range 4 mA ... 20 mA).

Tolerance and temperature response at $T_A = -25^\circ\text{C}$ to $+60^\circ\text{C}$	
Drift	
Typical	Maximum
$\pm 25$ ppm/K	$\pm 75$ ppm/K

The tolerance values refer to the measuring range final value.

Tolerances influenced by electromagnetic interference			
Type of electromagnetic interference	Standard	Tolerance	Criterion
Electromagnetic fields	EN 61000-4-3/ IEC 61000-4-3	$< \pm 1.0 \%$	A
Fast transients (burst)	EN 61000-4-4/ IEC 61000-4-4	$< \pm 1.0 \%$	A
Conducted interference	EN 61000-4-6/ IEC 61000-4-6	$< \pm 1.0 \%$	A

## 6 Internal circuit diagram

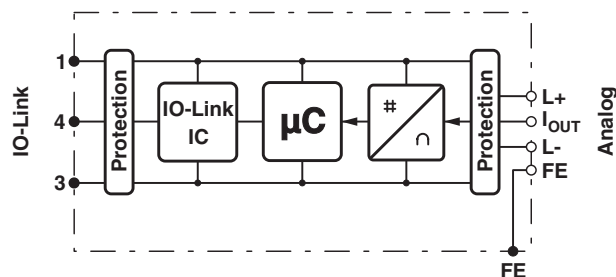
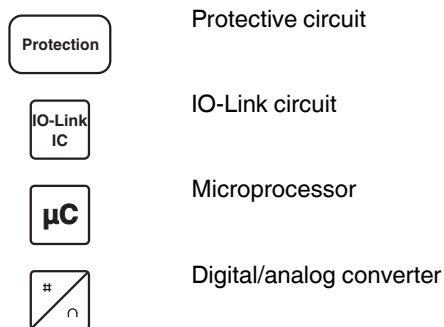

Figure 1 Internal wiring of connections

Key:



## 7 Pin assignment

### 7.1 Connections on the device

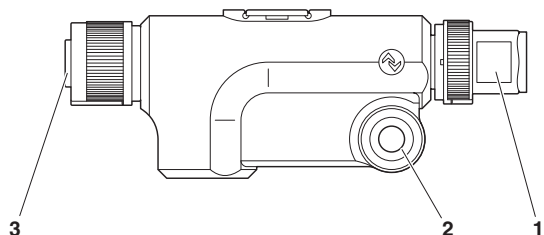

Figure 2 Connections on the converter

No.	Connection
1	IO-Link interface (indicated by IO-Link symbol)
2	Fixing options; options for connection to functional earth ground
3	Analog output

### 7.2 Pin assignment of the IO-Link interface

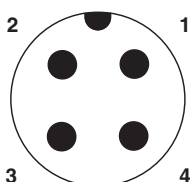

Figure 3 Pin assignment of the I/O link interface (M12 A-coded, pin)

Pin	Signal	Meaning
1	L+	+24 V supply voltage; from IO-Link master
2	-	Not used
3	L-	GND, reference potential for L+
4	C/Q	IO-Link data transmission channel

### 7.3 Pin assignment of the analog output

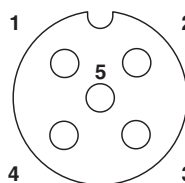

Figure 4 Pin assignment of the analog output (M12, A-coded, socket)

Pin	Assignment
1	+24 V, 100 mA
2	Current output 4 mA ... 20 mA
3	GND
4	Not used
5	Not used

## 8 Connection notes

Always connect the analog actuators using shielded twisted-pair cables.

## 9 Connection example

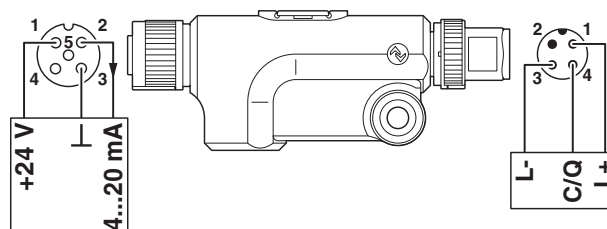

Figure 5 Connection example

## 10 Assembly

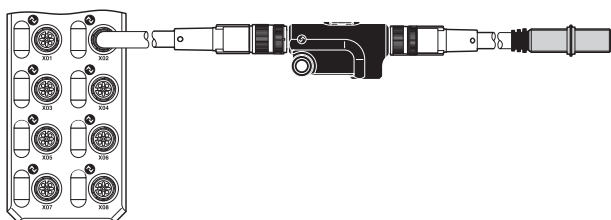

Figure 6 Connection of an actuator to an IO-Link master via the converter

- Connect the IO-Link interface of the converter to an IO-Link port of the higher-level IO-Link master using a standardized 3-pos. cable.
- Connect the analog actuator directly to the analog converter output or using a shielded 4-pos. cable.
- Fasten each connection using the M12 connectors.



In environments with high levels of interference, in particular, Phoenix Contact recommends connecting the converter to an appropriate functional earth ground point using an M4 screw.

## 11 Local status indicator

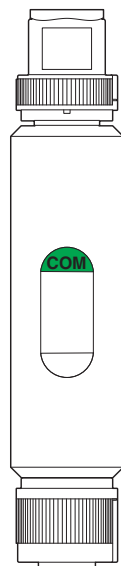

Figure 7 Local status indicator

Designation	Color	Meaning	State	Description
COM	Green	Status of IO-Link device	ON	Supply voltage OK
			Flashing	Supply voltage OK, SDCI communication active
			OFF	No supply voltage, no communication

## 12 Process data

The device occupies one word of IN process data and one word of OUT process data.

### 12.1 IN process data

The following data is transmitted in the input process data:

- During normal error-free operation, the output value is mirrored in the input process data for each channel.
- If an error occurs, the diagnostic message is mirrored in the input process data for each channel. The diagnostics message is deleted as soon as the error is eliminated.

#### Diagnostic messages in IB IL format

Code (hex)	Cause
8001	Overrange (Overflow)
8002	Open circuit
8040	Device faulty
8080	Underrange (Underflow)

#### Diagnostic messages in S7-compatible format

Code (hex)	Cause
7FFF	Overrange (Overflow)
8000	Open circuit/underrange (Underflow)

### 12.2 OUT process data

The output values are depicted in IB IL or S7-compatible format.

For both formats the output value is represented in bits 14 to 3. Bit 15 is available as a sign bit. Bits 2 to 0 are not relevant for the output value.

15	14	13	12	11	10	9	8	7	6	5	4	3	2	1	0
V	Analog value											x	x	x	

V Sign bit (= 0, not relevant)

x Not relevant for the output value (must be set to 0).

#### Parameterization

In addition, the device can be parameterized via the process data output word.

The following configurations are possible:

- Selection of formats for representing measured values
- Establishing substitute value behavior

15	14	13	12	11	10	9	8	7	6	5	4	3	2	1	0
Configuration	Reserved						Substitute value behavior in the event that IO-Link communication is aborted			Format		Reserved			



For the exact meaning of the individual bits, please refer to "Parameterization (80<sub>hex</sub>: ParaWord)".



Output values in the range from 8000 ... BFFF are interpreted as parameters.

### 12.3 Parameterization via OUT process data

Reparameterization can be carried out via the output process data, however this is not saved permanently on the device. The following sequence applies regardless of the format (IB IL or S7-compatible):



Only carry out re-parameterization when starting up the device!

The following sequence applies regardless of the format (IB IL or S7-compatible):

- The master interrupts the transmission of current process data and sends parameter data (OutputProcessData with bit 15 = 1)



In order to start configuration, bit 15 of the output word must be set to 1. If bit 15 = 0, the default configuration is active.

- The device interrupts the transmission of current process data and responds with the following diagnostic code in the process data:

Code (hex)	Cause
8800	Parameter OK
8801	Parameter ERROR

- If the diagnostic code is OK, the parameter data is accepted immediately. The master can end parameterization (OutputProcessData with bit 15 = 0). The device returns to normal operation with cyclic process data transmission.
- In the event of the ERROR diagnostic code, the master can abort parameterization without modified parameter data (OutputProcessData with bit 15 = 0) or transmit the modified parameterization (return to step 1).

### 12.4 Example

The example applies for the following changes:

- Switching the formats from S7-compatible (default) to IB IL
- For "hold last value"

15	14	13	12	11	10	9	8	7	6	5	4	3	2	1	0
Configuration	Reserved							Substitute value behavior in the event that IO-Link communication is aborted		Format		Reserved			
1	Reserved							1	0	1	0	Reserved			

## 13 Significant values in various formats

### 13.1 IB IL format

Resolution: 1 bit (0000 -> 0008) corresponds to 4.27  $\mu$ A.

Output data		4 mA ... 20 mA
hex	dec	mA
7F00	32512	21.339
7538	30008	20.00427
7530	30000	20.0
3A98	15000	12.0
0008	8	4.00463
0000	0	4.0



In the event of overrange, 8001<sub>hex</sub> is displayed on the input data.  
 In the event of underrange, 8080<sub>hex</sub> is displayed on the input data.  
 In the event of open circuit, 8002<sub>hex</sub> is displayed on the input data.  
 In the event of short circuit, the last value is held.

### 13.2 Format S7 compatible

Resolution: 1 bit (0000 -> 0008) corresponds to 4.63  $\mu$ A.

Output data		4 mA ... 20 mA
hex	dec	mA
7EF8	32504	22.81
6C08	27656	20.00463
3600	13824	12.0
0008	8	4.00463
0000	0	4.0
FFF8	-8	3.995
ED00	-4864	1.185



The S7 format enables the provision of currents < 4 mA. The range from FFF8<sub>hex</sub> to ED00<sub>hex</sub> is used for this.  
 This device can provide currents up to 1.185 mA, currents < 1 mA are not supported.



In the event of overrange, 7FFF<sub>hex</sub> is displayed on the input data.  
 In the event of underrange, 8000<sub>hex</sub> is displayed on the input data.  
 In the event of open circuit, 8000<sub>hex</sub> is displayed on the input data.  
 In the event of short circuit, the last value is held.

## 14 IO-Link objects

### 14.1 Overview of the objects

Index (hex)		Index (dec)		Object name	Length in bytes	Access	Meaning	Contents
DPP	ISDU	DPP	ISDU					
<b>Identification</b>								
0007		7		Vendor ID	2	R	Vendor ID	00 <sub>hex</sub>
0008		8						B0 <sub>hex</sub>
0009		9		Device ID	3	R	Device ID	01 <sub>hex</sub>
000A		10						00 <sub>hex</sub>
000B		11						3D <sub>hex</sub>
	0010		16	VendorName	64	R	Vendor name	Phoenix Contact
	0011		17	VendorText	64	R	Notes	phoenixcontact.com
	0012		18	ProductName	64	R	Product name	AXL E IOL AO1 I M12 S
	0013		19	Product ID	64	R	Order No.	2700351
	0014		20	ProductText	64	R	Product text	IO-Link/Analog-Converter Current Output Straight
	0015		21	SerialNumber	16	R	Serial number	Stored in the production process.
	0016		22	HardwareVersion	64	R	Hardware version	E.g., 01
	0017		23	FirmwareVersion	64	R	Firmware version	E.g., 001
<b>Diagnostics</b>								
	0020		32	ErrorCount	2	R	Errors since power up	Number of errors
	0029		41	OutputProcessData	2	R	Output process data	Last current data
<b>Parameter</b>								
	80		128	ParaWord	2	R/W	Parameterization	0000 <sub>hex</sub>

Abbreviation	Meaning
R	Read
W	Write

## 14.2 Parameterization (80<sub>hex</sub>: ParaWord)

Parameterize the device using this object. In the case of valid parameters, the parameterization is permanently stored on the device. After a reset, the device operates with the last permanently stored data. Upon delivery, the device operates with the default data (default settings).



Saving data to the device leads to a communication failure of around 30 ms.

15	14	13	12	11	10	9	8	7	6	5	4	3	2	1	0
Reserved								Substitute value behavior in the event that IO-Link communication is aborted		Format		Reserved			

In the following tables the values in **bold** are default settings.

Format	
Code (bin)	Meaning
<b>00</b>	<b>S7-compatible</b>
10	IB IL
Other	Reserved

Substitute value behavior in the event that IO-Link communication is aborted	
Code (bin)	Meaning
<b>00</b>	<b>Output of zero value (4 mA) at output</b>
01	Output of final value (20 mA) at output
10	Hold last value
11	Reserved
Other	Reserved



# SCATTERGOOD & JOHNSON LTD

ELECTRICAL ENGINEERING & FLUID CONTROL DISTRIBUTORS

Est.1899

At Scattergood & Johnson Ltd, we pride ourselves on being a technical distributor to specialist industries.

Working with a range of quality product suppliers across a number of specialist markets, we are not your average 'box shifter' - we are your technical and supply chain partner.

We fully support every product we sell - for free! Our internal team and external sales engineers can answer any product or application question, no matter the complexity.

Backing up this technical ability is a range of 50,000+ products available from stock for nationwide next day delivery (same day if required!), or you can collect what you need from any of our trade counters around the UK.

Select your specialist interest below to learn more about how we can help.



Online, In Branch and On the Road - Scattergood & Johnson Ltd, there when you need us.

# [www.scatts.co.uk](http://www.scatts.co.uk)