



**Installing and operating the
ILC 131 ETH, ILC 151 ETH,
ILC 171 ETH 2TX,
ILC 191 ETH 2TX, ILC 131 ETH/XC,
and ILC 151 ETH/XC Inline control-
lers**

User manual

User manual

Installing and operating the ILC 131 ETH, ILC 151 ETH, ILC 171 ETH 2TX, ILC 191 ETH 2TX, ILC 131 ETH/XC, and ILC 151 ETH/XC Inline controllers

2015-10-09

Designation: UM EN ILC 1X1

Version: 02

Order No.: —

This user manual is valid for:

| Designation | As of version (HW) | As of version (FW) | Order No. |
|-----------------|--------------------|--------------------|-----------|
| ILC 131 ETH | 00 | 4.00 | 2700973 |
| ILC 151 ETH | 00 | 4.00 | 2700974 |
| ILC 171 ETH 2TX | 00 | 4.00 | 2700975 |
| ILC 191 ETH 2TX | 00 | 4.00 | 2700976 |
| ILC 131 ETH/XC | 00 | 4.00 | 2701034 |
| ILC 151 ETH/XC | 00 | 4.00 | 2701141 |

Please observe the following notes

User group of this manual

The use of products described in this manual is oriented exclusively to qualified electricians or persons instructed by them, who are familiar with applicable standards and other regulations regarding electrical engineering and, in particular, the relevant safety concepts.

Explanation of symbols used and signal words



This is the safety alert symbol. It is used to alert you to potential personal injury hazards. Obey all safety measures that follow this symbol to avoid possible injury or death.

There are three different categories of personal injury that are indicated with a signal word.

DANGER This indicates a hazardous situation which, if not avoided, will result in death or serious injury.

WARNING This indicates a hazardous situation which, if not avoided, could result in death or serious injury.

CAUTION This indicates a hazardous situation which, if not avoided, could result in minor or moderate injury.



This symbol together with the signal word **NOTE** and the accompanying text alert the reader to a situation which may cause damage or malfunction to the device, hardware/software, or surrounding property.



This symbol and the accompanying text provide the reader with additional information or refer to detailed sources of information.

How to contact us

Internet

Up-to-date information on Phoenix Contact products and our Terms and Conditions can be found on the Internet at:

phoenixcontact.com

Make sure you always use the latest documentation.

It can be downloaded at:

phoenixcontact.net/products

Subsidiaries

If there are any problems that cannot be solved using the documentation, please contact your Phoenix Contact subsidiary.

Subsidiary contact information is available at phoenixcontact.com.

Published by

PHOENIX CONTACT GmbH & Co. KG
Flachsmarktstraße 8
32825 Blomberg
GERMANY

Should you have any suggestions or recommendations for improvement of the contents and layout of our manuals, please send your comments to:

tecdoc@phoenixcontact.com

Please observe the following notes

General terms and conditions of use for technical documentation

Phoenix Contact reserves the right to alter, correct, and/or improve the technical documentation and the products described in the technical documentation at its own discretion and without giving prior notice, insofar as this is reasonable for the user. The same applies to any technical changes that serve the purpose of technical progress.

The receipt of technical documentation (in particular user documentation) does not constitute any further duty on the part of Phoenix Contact to furnish information on modifications to products and/or technical documentation. You are responsible to verify the suitability and intended use of the products in your specific application, in particular with regard to observing the applicable standards and regulations. All information made available in the technical data is supplied without any accompanying guarantee, whether expressly mentioned, implied or tacitly assumed.

In general, the provisions of the current standard Terms and Conditions of Phoenix Contact apply exclusively, in particular as concerns any warranty liability.

This manual, including all illustrations contained herein, is copyright protected. Any changes to the contents or the publication of extracts of this document is prohibited.

Phoenix Contact reserves the right to register its own intellectual property rights for the product identifications of Phoenix Contact products that are used here. Registration of such intellectual property rights by third parties is prohibited.

Other product identifications may be afforded legal protection, even where they may not be indicated as such.

Table of contents

| | | |
|--------|--|----|
| 1 | Foreword | 9 |
| 1.1 | Purpose of this user manual | 9 |
| 1.2 | Hardware and software requirements | 9 |
| 1.3 | General safety notes..... | 10 |
| 1.4 | Intended use..... | 10 |
| 1.5 | Disposal..... | 10 |
| 2 | Description of the Inline controller | 11 |
| 2.1 | General description of the Inline controller..... | 11 |
| 2.2 | Possible fields of application of the Inline controller..... | 13 |
| 2.2.1 | ILC 131 ETH and ILC 131 ETH/XC | 13 |
| 2.2.2 | ILC 151 ETH, ILC 151 ETH/XC, ILC 171 ETH 2TX, and ILC 191 ETH 2TX | 13 |
| 2.2.3 | The Inline controller as a PROFINET device in a PROFINET network .. | 15 |
| 2.2.4 | Applicative system redundancy with ILC 171 ETH 2TX or ILC 191 ETH 2TX | 16 |
| 2.3 | Notes on using the Inline controller in potentially explosive areas | 17 |
| 2.4 | Unpacking the Inline controller..... | 18 |
| 2.5 | Connection and operating elements | 19 |
| 2.6 | Diagnostics and status indicators | 21 |
| 2.7 | Mode selector switch | 24 |
| 2.8 | Reset button (concealed) | 25 |
| 2.9 | Parameterization memory..... | 25 |
| 2.9.1 | Inserting/removing the parameterization memory | 26 |
| 2.10 | Internal basic circuit diagram | 27 |
| 2.11 | Mounting and removing the Inline controller | 28 |
| 2.12 | Communication paths..... | 32 |
| 2.12.1 | Ethernet | 33 |
| 2.12.2 | Serial PRG interface (mini-DIN socket) | 34 |
| 2.12.3 | Serial PRG interface - function blocks | 35 |
| 2.13 | INTERBUS | 36 |
| 2.13.1 | Local bus | 36 |
| 2.13.2 | Remote bus | 36 |
| 2.14 | Power supply | 37 |
| 2.14.1 | Sizing of the power supply | 37 |
| 2.14.2 | Connecting the power supplies | 38 |
| 2.14.3 | 24 V segment supply/24 V main supply | 40 |
| 2.14.4 | 24 V segment supply | 40 |
| 2.14.5 | 24 V main voltage | 40 |
| 2.14.6 | 24 V ILC supply | 40 |
| 2.14.7 | Jumpering | 40 |
| 2.15 | Digital inputs and outputs | 41 |

ILC 1X1

| | | |
|----------|--|-----------|
| 3 | The Inline controller under PC Worx/PC Worx Express | 43 |
| 3.1 | Software version..... | 43 |
| 3.2 | Creating a new project..... | 44 |
| 3.3 | Assigning the IP address for the controller..... | 45 |
| 3.3.1 | Dynamic Configuration Protocol (DCP) | 45 |
| 3.3.2 | BootP server | 46 |
| 3.4 | The Inline controller as a PROFINET device..... | 49 |
| 3.5 | Setting the realtime clock under PC Worx Express..... | 55 |
| 3.6 | Download changes | 55 |
| 3.7 | Functions of the plug-in parameterization memory (SD card)..... | 56 |
| 3.7.1 | Main memory | 56 |
| 3.7.2 | Additional memory | 58 |
| 3.7.2.1 | SD card as memory for log files | 59 |
| 3.8 | Parameterization memory and Internet Explorer..... | 62 |
| 3.8.1 | Internet Explorer FTP functionality | 63 |
| 3.8.2 | Activating/deactivating the FTP server | 64 |
| 3.8.3 | Access restriction for FTP access | 65 |
| 3.8.4 | Activating/deactivating the HTTP server | 68 |
| 3.8.5 | Using the Hypertext Transfer Protocol Secure (HTTPS) | 69 |
| 3.9 | Sending secure e-mails | 69 |
| 3.10 | Enabling/disabling specific ports | 70 |
| 3.11 | Activating/deactivating the journaling function | 71 |
| 3.12 | Activating/deactivating the MRP client function | 72 |
| 3.13 | Function blocks for handling files on the parameterization memory..... | 73 |
| 3.14 | Function blocks for Ethernet communication | 74 |
| 3.15 | Function blocks for PCP communication | 75 |
| 3.16 | Alignment | 76 |
| 4 | System variables and status information | 79 |
| 4.1 | General notes | 79 |
| 4.2 | Status register for local digital inputs and outputs..... | 79 |
| 4.3 | Diagnostic status register | 80 |
| 4.4 | Diagnostic parameter register..... | 81 |
| 4.5 | PROFINET register..... | 82 |
| 4.6 | IEC 61131 runtime system..... | 83 |
| 4.7 | Control processor | 84 |
| 4.8 | Power storage, realtime clock..... | 84 |
| 4.9 | Power supplies | 85 |
| 4.10 | Mode selector switch | 85 |

Table of contents

| | | |
|----------|---|------------|
| 4.11 | System time | 85 |
| 5 | Technical data and ordering data | 87 |
| 5.1 | Technical data | 87 |
| 5.2 | Ordering data..... | 95 |
| 5.2.1 | Modules | 95 |
| 5.2.2 | Accessories | 95 |
| 5.2.3 | Software | 95 |
| 5.2.4 | Documentation | 95 |
| A | Appendix: service, maintenance, derating, and ambient conditions | 97 |
| A 1 | Error causes and remedies..... | 97 |
| A 2 | Updating the Inline controller firmware..... | 97 |
| A 3 | Connecting unshielded cables..... | 98 |
| A 4 | Derating..... | 99 |
| A 5 | Tested successfully: use under extreme ambient conditions..... | 101 |
| B | Appendix for document lists..... | 103 |
| B 1 | List of figures | 103 |
| B 2 | List of tables | 107 |
| B 3 | Index..... | 109 |

ILC 1X1

1 Foreword

1.1 Purpose of this user manual

This user manual helps you to start up and operate the following Inline controllers:

- ILC 131 ETH,
- ILC 151 ETH,
- ILC 171 ETH 2TX,
- ILC 191 ETH 2TX,
- ILC 131 ETH/XC or
- ILC 151 ETH/XC.

1.2 Hardware and software requirements

| HW/SW | Description | | | | | |
|--|--|---|---|---|---|---|
| Inline controller | ILC 131 ETH | ILC 151 ETH | ILC 171 ETH 2TX | ILC 191 ETH 2TX | ILC 131 ETH/XC | ILC 151 ETH/XC |
| Parameterization memory, plug-in | For ordering data, see Section "Accessories" on page 95 | For ordering data, see Section "Accessories" on page 95 | For ordering data, see Section "Accessories" on page 95 | For ordering data, see Section "Accessories" on page 95 | For ordering data, see Section "Accessories" on page 95 | For ordering data, see Section "Accessories" on page 95 |
| Ethernet cable | Ethernet cable for connecting the Inline controller to a PC | | | | | |
| Connecting cable | Connecting cable for connecting the Inline controller to a PC (RS-232 cable, optional) | | | | | |
| Automation software versions (Service Pack = SP) | | | | | | |
| PC Worx | ≥ 6.20 * | ≥ 6.20 * | ≥ 6.20 SP 1 ** | ≥ 6.20 SP 1 ** | ≥ 6.20 * | ≥ 6.20 * |
| PC Worx Express | ≥ 6.20 * | ≥ 6.20 * | ≥ 6.20 SP 1 ** | ≥ 6.20 SP 1 ** | ≥ 6.20 * | ≥ 6.20 * |

* Part of the AUTOMATIONWORX Software Suite 2012 1.70

** Part of the AUTOMATIONWORX Software Suite 2012 1.70 Service Pack 1



For the ordering data for hardware, software, and additional documentation, please refer to Section "Technical data and ordering data" on page 87.

PROFINET device function



The PROFINET device function of the controllers is not supported by the PC Worx Express software.

1.3 General safety notes

Observe the country-specific installation, safety, and accident prevention regulations.

During startup and maintenance work, proceed in accordance with the five safety rules of DIN EN 50110-1. In general, the rules should be observed in the specified order:

- Disconnect safely
- Ensure power cannot be switched on again
- Verify safe isolation from the supply
- Ground and short circuit
- Cover or safeguard adjacent live parts

Once the work is complete, perform the above steps again in reverse order.



NOTE:

The IP20 degree of protection (IEC 60529/EN 60529) of the device is intended for a clean and dry environment. Do not subject the device to mechanical and/or thermal loads that exceed the specified limits.



NOTE: Risk of unauthorized network access

Connecting devices to a network via Ethernet always entails the risk of unauthorized access to the network.

Please check your application for any option of deactivating active communication channels (for instance SNMP, FTP, BootP, DCP, etc.), or setting passwords to prevent third parties from unauthorizedly accessing the controller and modifying the system.

With regard to the controller's communication interfaces, we recommend not to use the controller in safety-critical applications unless using additional security devices.

So, please take additional protective measures according to the IT security requirements and the standards applicable to your application (for instance virtual networks (VPN) for remote maintenance access, firewalls, etc.) for protection against unauthorized network access.

For the protection of networks for remote maintenance via VPN, Phoenix Contact offers the mGuard product series security devices which you can find described in the latest Phoenix Contact catalog (phoenixcontact.net/products).

1.4 Intended use

The Inline controller is a modular small-scale controller that can be used for small and medium-size applications. The device corresponds to IP20 protection and can be used in closed control cabinets or in control boxes (terminal boxes) with IP54 protection or higher. This device is designed for use in industrial environments.

1.5 Disposal



Do not dispose of the device with household waste, it should instead be disposed of in accordance with the currently applicable national regulations. The device can also be returned to Phoenix Contact.

2 Description of the Inline controller

2.1 General description of the Inline controller

The Inline controller is a modular small-scale controller with integrated Ethernet and INTERBUS connections.



The ILC 131 ETH, ILC 151 ETH, ILC 171 ETH 2TX, ILC 191 ETH 2TX, ILC 131 ETH/XC, and ILC 151 ETH/XC Inline controllers have the same appearance and numerous identical functions.

The main difference lies in the varying memory sizes, which are available to the user.

The ILC 171 ETH 2TX and ILC 191 ETH 2TX Inline controllers also have a second Ethernet interface.

The ILC 131 ETH/XC and ILC 151 ETH/XC Inline controllers are approved for use under extreme ambient conditions. Observe the notes in Section “Ambient conditions” on page 93 and in Section “Tested successfully: use under extreme ambient conditions” on page 101.

In the following, the term Inline controller is used in general. Differences between the controllers are explicitly mentioned where necessary.

For additional information about the different memory sizes, please refer to Section 5.1, “Technical data”.

IEC 61131 controller performance

The Inline controller is consistently configured and programmed in accordance with IEC 61131 using the PC Worx automation software. PC Worx can be operated via the network (Ethernet). The powerful processor can be programmed in all five IEC 61131 programming languages and ensures quick control task processing.

Integrated Ethernet connection

The integrated Ethernet connection (via twisted pair cable) ensures Ethernet connectivity. Throughout the Ethernet network, the Inline controller can be accessed via TCP/IP or UDP/IP. A standardized Ethernet interface is available for each of the ILC 131 ETH, ILC 151 ETH, ILC 131 ETH/XC and ILC 151 ETH/XC Inline controllers. The ILC 171 ETH 2TX and ILC 191 ETH 2TX controllers have two fully implemented Ethernet connections, which are switched inside the device.

Integrated communication functions enable direct and effective data exchange via Ethernet. The Ethernet network provides universal options for communicating with the Inline controller. Using the IP_USEND and IP_URCV communication blocks, information, such as required coupling variables, can be exchanged between Inline controllers via Ethernet. This enables distributed, modular automation solutions to be configured.

The existing IEC 61131-5 blocks have therefore been extended to include a transparent TCP/IP mode and a transparent UDP/IP mode.

When using the AX OPC server provided in the AUTOMATIONWORX Software Suite Version 1.30 or later, Inline controller data is available in the Ethernet network in a standardized format and can be used for the different visualization packages.

ILC 1X1

PROFINET device functionality

The PROFINET protocol can be used via the Ethernet interfaces of the Inline controllers. In this case, the Inline controllers can be used as a PROFINET device. All the Inline controllers listed in Section 1.1 support this function from hardware version "01"/firmware version "4.10" or later together with the PC Worx software version 6.20 Service Pack 1 or later.



For information on how to configure the Inline controllers as a PROFINET device in the PC Worx software, please refer to Section "The Inline controller as a PROFINET device" on page 49.

Modbus functionality

The Modbus/TCP (UDP) communication protocol can be used via the Ethernet interfaces of the Inline controller. The Inline controller can be used as a Modbus/TCP client and/or as a Modbus/TCP server (as of firmware version 4.40 and AUTOMATIONWORX Software Suite Version 1.82 AddOn V1). For additional information, please refer to the AH EN MODBUS TCP application note.

MRP

The Media Redundancy Protocol MRP can be used via the Ethernet interfaces of the ILC 171 ETH 2TX and ILC 191 ETH 2TX Inline controllers. The controllers support the MRP client function, which can be enabled or disabled via PC Worx as an option. This function is disabled by default. If the function is enabled, it remains enabled after the supply voltage is switched off and on. If the controllers have been reset to the delivery state, the MRP client function will also be disabled again. In a ring with Media Redundancy Protocol, maximum switch-over times of up to 200 ms can be expected.

Integrated INTERBUS connection

An Inline local bus as well as an INTERBUS remote bus can be connected via the INTERBUS connection. In this way you can create a complete INTERBUS system (maximum of 4 remote bus levels) using the Inline controller as a distributed controller.

The I/O level is connected to the Inline controller via INTERBUS.



Please note: the ILC 131 ETH and ILC 131 ETH/XC controllers do not support connection of the INTERBUS remote bus.

RS-232 interface

This interface can be used to **either** assign the IP address of the Inline controller and to access the controller using the Diag+ diagnostics tool **or** to communicate with serial I/O devices via function blocks.



The Inline controller cannot be programmed via the RS-232 interface.

Parameterization memory/SD card

All Inline controllers can be operated using a plug-in parameterization memory in the form of an SD card. This memory can be used to save programs and configurations which belong to your project.

The plug-in parameterization memory is optional and is not required in order to operate the Inline controller.



The parameterization memory is not supplied as standard with the Inline controllers. Only use a parameterization memory provided by Phoenix Contact (for ordering data, see Section "Accessories" on page 95).



NOTE: Parameterization memory (SD card) – formatting note

The SD card is already formatted and is intended for use with Phoenix Contact devices. Make sure that the SD card is not reformatted.

2.2 Possible fields of application of the Inline controller

2.2.1 ILC 131 ETH and ILC 131 ETH/XC

The Inline controllers (ILC 131 ETH/ILC 131 ETH/XC) can be used as a distributed controller of an Inline station, which is connected to an Ethernet system. An Inline local bus (Figure 2-1) can then be connected to the Inline controller.

Inline local bus

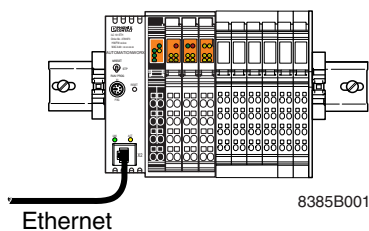

Figure 2-1 Connected Inline local bus



Please note: the Inline controllers (ILC 131 ETH / ILC 131 ETH/XC) do not support connection of the INTERBUS remote bus.

2.2.2 ILC 151 ETH, ILC 151 ETH/XC, ILC 171 ETH 2TX, and ILC 191 ETH 2TX

The Inline controllers (ILC 151 ETH/ILC 151 ETH/XC/ILC 171 ETH 2TX/ILC 191 ETH 2TX) can be used as a distributed controller of an Inline station, which is connected to an Ethernet system. A single Inline local bus (Figure 2-2) as well as a INTERBUS system with a maximum of 4 remote bus levels (Figure 2-3) can be connected to the Inline controller.

Inline local bus

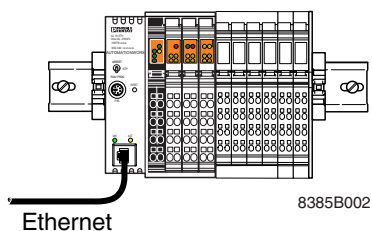
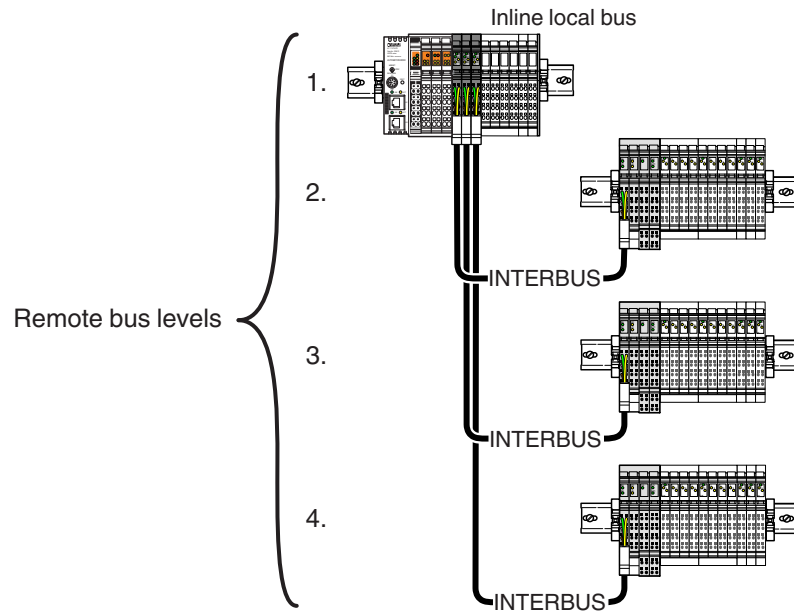

Figure 2-2 Connected Inline local bus

ILC 1X1

Remote bus levels



8385B003

Figure 2-3 Remote bus levels

2.2.3 The Inline controller as a PROFINET device in a PROFINET network

The following figure shows the example of an ILC 171 ETH 2TX as a PROFINET device in a PROFINET network.

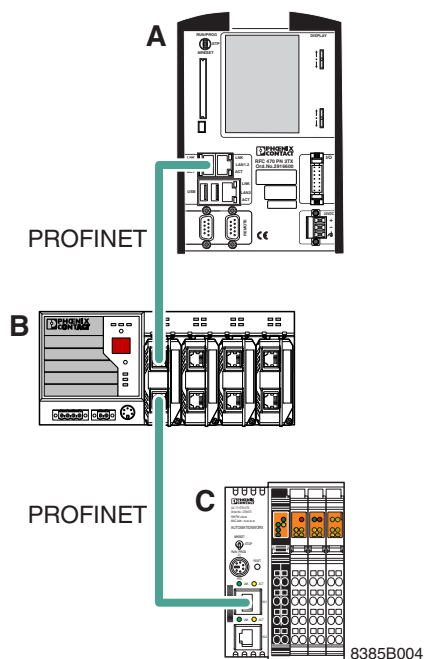

Figure 2-4 PROFINET device using the ILC 171 ETH 2TX as an example

Key:

- A** PROFINET controller (in the example: RFC 470 PN 3TX Remote Field Controller)
- B** Managed Switch
- C** PROFINET device (in the example: ILC 171 ETH 2TX)



For additional information on how to integrate the Inline controller into a PROFINET network as a PROFINET device, please refer to Section "The Inline controller as a PROFINET device" on page 49.

2.2.4 Applicative system redundancy with ILC 171 ETH 2TX or ILC 191 ETH 2TX

The following figure shows an example of applicative system redundancy. The example shows a PROFINET device with control function (ILC 171 ETH 2TX) that is connected to a PROFINET network by means of a switch. Identical application programs run on both higher-level PROFINET controllers. To achieve synchronization, both PROFINET controllers are connected via an Ethernet connection by means of a switch. PROFINET controller A operates as primary controller, PROFINET controller B operates as backup controller.

The ILC 191 ETH 2TX also supports applicative system redundancy.

Controllers with applicative (programmed) redundancy

Network redundancy with Media Redundancy Protocol (MRP)

PROFINET devices with Phoenix Redundancy Layer

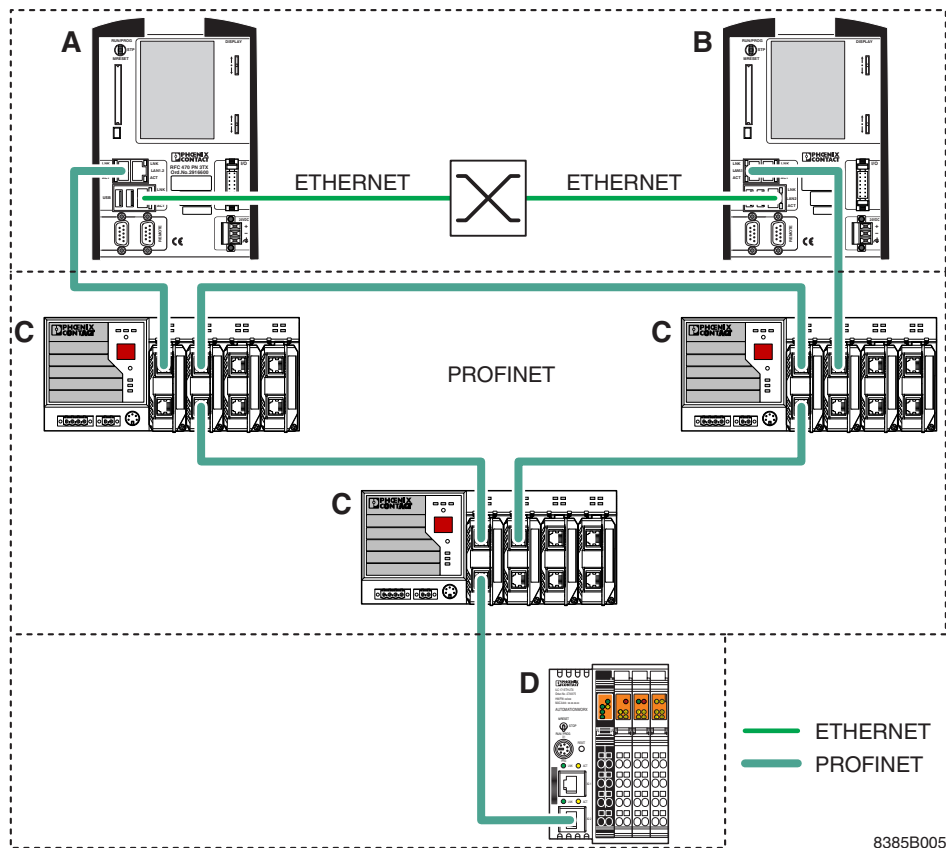

8385B005

Figure 2-5 Applicative system redundancy – example



For additional information on applicative system redundancy, please refer to the AH EN APPLICATIVE SYSTEM REDUNDANCY application note. This application note can be downloaded at phoenixcontact.net/products.

- A** Primary controller (in the example: RFC 470 PN 3TX Remote Field Controller)
- B** Backup controller (in the example: RFC 470 PN 3TX Remote Field Controller)
- C** Managed Switches
- D** PROFINET device with control function (in the example: ILC 171 ETH 2TX with PROFINET device function and Phoenix Redundancy Layer)

2.3 Notes on using the Inline controller in potentially explosive areas

Approval according to directive 94/9/EC

 II 3G Ex nA IIC T4 Gc X



WARNING: Explosion hazard

Make sure that the following notes and instructions are observed.

Installation notes

1. The Inline controller conforms to the requirements of protection type “n” and can be installed in a zone 2 potentially explosive area. The Inline controller is a category 3G item of electrical equipment.
The Inline controller meets the requirements of EN 60079-0:2009 and EN 60079-15:2010.
2. The Inline controller must only be installed, started up, and maintained by qualified specialist personnel.
3. Please follow the installation instructions given in the user manual and the package slip.
4. When installing and operating the device, the applicable safety directives (including national safety directives), accident prevention regulations, as well as general technical regulations must be observed.
5. For the safety data, please refer to the corresponding documentation (user manual, package slip) and the certificates (declaration of conformity and other approvals, if applicable).
6. Access to the circuits inside the Inline controller is not permitted. Do not repair the Inline controller yourself but replace it with an approved controller of the same type. Repairs may only be performed by the manufacturer. The manufacturer is not liable for damage resulting from noncompliance.
7. The IP20 (EN 60529) degree of protection for the device is designed for a clean and dry environment.
8. Do not subject the Inline controller to mechanical strain and/or thermal loads that exceed the limits specified in the product documentation.
9. The Inline controller is not designed for use in potentially dust-explosive atmospheres. If dust is present, install the device in suitable, approved housing. Please note the surface temperature of the housing.

Installation in zone 2

1. Observe the specified conditions for use in potentially explosive areas.
2. Install the device in a suitable approved housing (with at least IP54 protection according to EN 60529) that meets the requirements of EN 60079-15.
3. In potentially explosive areas, only snap the device onto the DIN rail and remove it from the DIN rail and connect and disconnect the cables when the power is disconnected.
4. Connect the DIN rail to protective earth ground.
5. Only connect devices to the supply and signal circuits in zone 2 that are suitable for operation in potentially explosive areas of zone 2 and for the conditions at the installation location.
6. To ensure safe operation, the RJ45 connector needs to have a fully functioning locking clip. Repair any damaged connectors immediately.

7. For safe operation with the plug-in parameterization memory (SD card), this must be fully plugged and snapped in. In potentially explosive areas, use the SD card as main memory only. Don't insert or remove the SD card during operation.
8. The programming interface may only be used if there is no potentially explosive atmosphere.

Restrictions/limit values

1. **Only Inline terminals that are approved for use in potentially explosive areas may be snapped next to the Inline controller.**
Before using the Inline terminal in a zone 2 potentially explosive area, check whether this Inline terminal has been approved for installation within this area.
For a list of terminals that are approved for zone 2 potentially explosive areas, please refer to the AH EN IL EX ZONE 2 application note.
2. Please make sure that the maximum permissible current of 4 A flowing through potential jumpers U_M and U_S (total current) is not exceeded when using the Inline controller in potentially explosive areas.
3. Also make sure that the maximum permissible current of 2 A flowing through potential jumper U_L is not exceeded.
4. The maximum permissible current for each spring-cage contact is 2 A.

2.4 Unpacking the Inline controller

The Inline controller is supplied in an ESD bag together with a package slip with installation instructions. Read the complete package slip carefully before unpacking the Inline controller.



NOTE: Electrostatic discharge

The Inline controller contains components that can be damaged or destroyed by electrostatic discharge. When handling the Inline controller, observe the necessary safety precautions against electrostatic discharge (ESD) according to EN 61340-5-1 and IEC 61340-5-1.



NOTE:

To avoid possible damage to the module, unpack and pack the Inline controller in accordance with the ESD regulations.

2.5 Connection and operating elements

ILC 131 ETH,
ILC 151 ETH,
ILC 131 ETH/XC,
ILC 151 ETH/XC

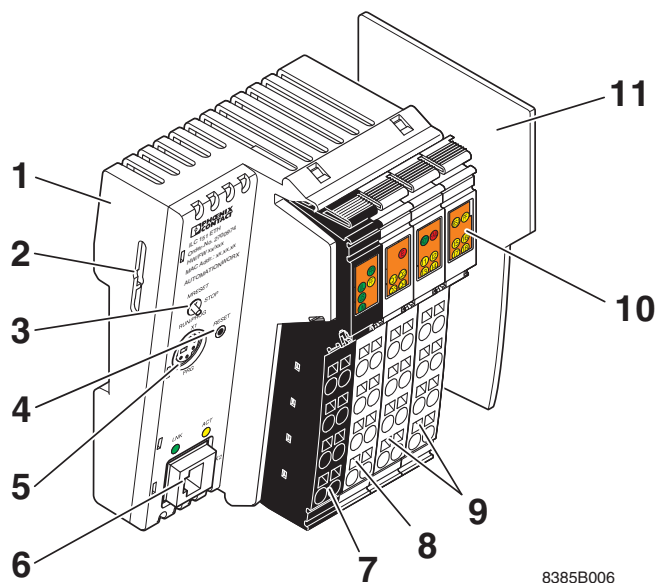

Figure 2-6 Structure of the Inline controller (ILC 131 ETH, ILC 151 ETH, ILC 131 ETH/XC, ILC 151 ETH/XC; shown in the figure: ILC 151 ETH)

The Inline controller consists of the following components:

- 1 Electronics base
- 2 Slot for the parameterization memory/card holder (SD card)



The SD card is not supplied as standard with the Inline controller.

Please refer to the ordering data in Section "Accessories" on page 95.

- 3 Mode selector switch
- 4 Reset button
- 5 RS-232 interface
- 6 Ethernet connection
- 7 Connector 1: terminal points for voltage supply
- 8 Connector 2: output terminal points
- 9 Connectors 3 and 4: input terminal points
- 10 Diagnostics and status indicators
- 11 End plate

ILC 1X1

ILC 171 ETH 2TX,
ILC 191 ETH 2TX

Figure 2-7 Structure of the Inline controller (ILC 171 ETH 2TX, ILC 191 ETH 2TX; shown in the figure: ILC 171 ETH 2TX) 8385B007

The Inline controller consists of the following components:

- 1 Electronics base
- 2 Slot for the parameterization memory/card holder (SD card).

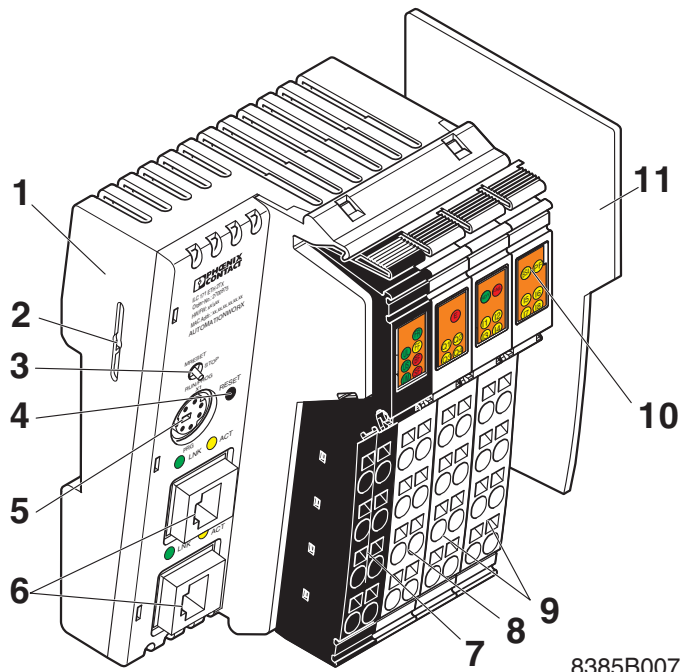

The SD card is not supplied as standard with the Inline controller.

Please refer to the ordering data in Section "Accessories" on page 95.

- 3 Mode selector switch
- 4 Reset button
- 5 RS-232 interface (X1)
- 6 Ethernet interfaces (X2.1/X2.2)
- 7 Connector 1: terminal points for voltage supply
- 8 Connector 2: output terminal points
- 9 Connectors 3 and 4: input terminal points
- 10 Diagnostics and status indicators
- 11 End plate

2.6 Diagnostics and status indicators



The descriptions for diagnostic and status indicators apply to all the Inline controllers listed on the inner cover page of this user manual.

The diagnostics and status indicators are used for quick local error diagnostics.

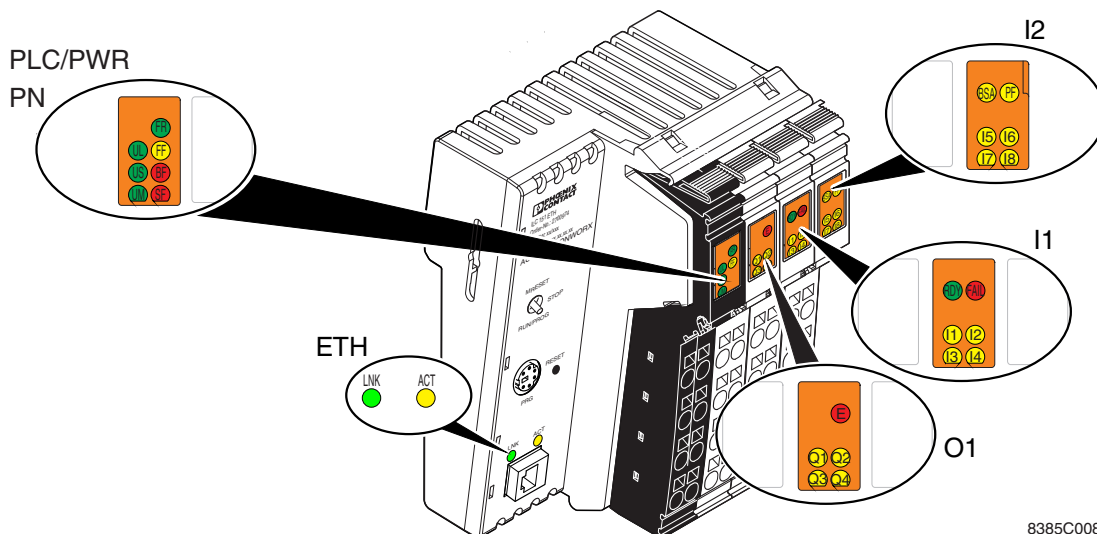

8385C008

Figure 2-8 Diagnostics and status indicators

Local diagnostics and status indicators

| Des. | Color | Status | Meaning |
|--|--------|--|---|
| ETH: state of the Ethernet interface (applies to both interfaces (X2.1, X2.2) for the ILC 171 ETH 2TX/ILC 191 ETH 2TX) | | | |
| LNK | Green | Off | Connection not established successfully |
| | | On | Connection established successfully (link): the Inline controller is able to contact another network device. |
| ACT | Yellow | Off | Data transmission inactive |
| | | On | Data transmission active (activity): the Ethernet interface is sending or receiving data |
| PN: PROFINET (for ILC 131 ETH(/XC) and ILC 151 ETH(/XC) from HW version 0.1 or later and FW version 4.10 or later) | | | |
| BF | Red | Status of PROFINET communication/communication error (BusFail) | |
| | | Off | The higher-level PROFINET controller has established an active communication connection to the PROFINET device. |
| | | On | The PROFINET device has not established an active communication connection to a higher-level PROFINET controller. |
| | | Flashing | The higher-level PROFINET controller establishes a communication connection to the PROFINET device. |

ILC 1X1

| Des. | Color | Status | Meaning |
|---|--------|----------|---|
| SF | Red | | Group error (PROFINET) |
| | | Off | PROFINET diagnostics not present. |
| | | On | PROFINET diagnostics present. |
| PLC: diagnostics of the Inline controller | | | |
| FR | Green | | Inline controller running |
| | | Off | IEC 61131 runtime system not ready to operate. |
| | | Flashing | IEC 61131 runtime system successfully initialized. Control function is in the READY/STOP state, program not processed. |
| | | On | IEC 61131 runtime system successfully initialized and a program is running. Control function is in the RUN state. |
| FF | Yellow | | Failure |
| | | On | A runtime error has occurred in the IEC 61131 runtime system program. |
| | | Off | No runtime error has occurred in the IEC 61131 runtime system program. |
| PWR: supply voltage (see also Section "Remote bus" on page 36) | | | |
| UL | Green | | 24 V supply U_{ILC} for generating voltages U_L and U_{ANA} |
| | | Off | Supply voltage not present |
| | | On | Supply voltage is present (the presence of the 24 V supply voltage U_{ILC} is indicated) |
| US | Green | | 24 V supply for segment circuit |
| | | Off | Supply voltage not present |
| | | On | Supply voltage is present. |
| UM | Green | | 24 V supply for main circuit |
| | | Off | Supply voltage not present |
| | | On | Supply voltage is present. |
| IL: INTERBUS diagnostics | | | |
| RDY | Green | | INTERBUS master ready to operate/data transmission active (INTERBUS ready/running) |
| | | Off | The INTERBUS master is not ready to operate. |
| | | Flashing | The INTERBUS master is in the READY or ACTIVE state. |
| | | On | The INTERBUS master is in the RUN state. |
| FAIL | Red | | Failure |
| | | Off | No error occurred: |
| | | On | One of the following errors has occurred: – Bus error in the connected bus (remote bus/local bus) – Controller error. |
| BSA | Yellow | | Bus segment aborted |
| | | Off | Bus segment(s) in the connected bus not switched off. |
| | | On | One or more bus segments in the connected bus are switched off. |

Description of the Inline controller

| Des. | Color | Status | Meaning |
|--|--------|--------|--|
| PF | Yellow | | Peripheral fault |
| | | Off | No peripheral fault on a device in the connected bus. |
| | | On | Peripheral fault on a device in the connected bus (local bus or remote bus). |
| I/O: digital inputs and outputs | | | |
| I1 to I8 | Yellow | | Inputs 1 to 8 |
| | | Off | Corresponding input is not set. |
| | | On | Corresponding input is set. |
| E | Yellow | | Error |
| | | Off | No short circuit/overload at one or more outputs |
| | | On | Short circuit/overload at at least one of the outputs (1 to 4). |
| Q1 to Q4 | Yellow | | Outputs 1 to 4 |
| | | Off | Corresponding output is not set. |
| | | On | Corresponding output is set. |

2.7 Mode selector switch

The mode selector switch is used to define the operating state of the controller.

The RUN/PROG and STOP positions have a latching function and the MRESET position has a momentary-action function. After releasing the switch in the MRESET position, it returns to STOP.

Table 2-1 Inline controller operating modes

| Operating mode | Explanation |
|----------------|---|
| RUN/PROG | <p>The controller is in the RUN state. The application program is being processed.</p> <p>The PC Worx/PC Worx Express software can be used for program and configuration modifications as well as for the online monitoring function.</p> <div style="border: 1px solid black; padding: 5px; margin-top: 10px;"> <p> The application program is not processed if a controller error has occurred or if the application program has been stopped by PC Worx/PC Worx Express.</p> </div> |
| STOP | <p>The controller is in the STOP state. Application program processing has been stopped.</p> |
| MRESET | <p>Retain data and the application program are deleted.</p> <p>Set the mode selector switch in the following sequence to delete the retain data and the application program:</p> <ul style="list-style-type: none"> • Set the switch to the MRESET position for three seconds. • Release the switch for less than three seconds. • Set the switch to the MRESET position for three seconds. |

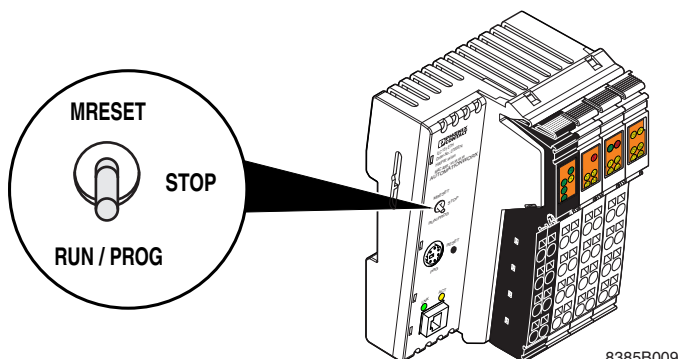

Figure 2-9 Mode selector switch

2.8 Reset button (concealed)

The reset button on the Inline controller (see item 4 in Figure 2-6 on page 19/item 4 in Figure 2-7 on page 20) can only be operated with a pointed object (such as a pen) and is therefore protected against accidental activation.

If you carry out a voltage reset simultaneously as you press the reset button, this resets the Inline controller to its default settings.

How to proceed

Hold down the reset button and switch the supply voltage of the Inline controller off and on again. Release the reset button only after the FF (yellow) LED starts flashing.

The Inline controller has been initialized successfully and reset to its default settings only after the FR (green) and RDY (green) LEDs are flashing. The control function is in the READY/STOP state, a program is not processed. This process may take around 1 minute.

2.9 Parameterization memory

The parameterization memory can be used to save programs and configurations which belong to your project. In addition, application-specific data can also be stored on the parameterization memory. Refer to the Section "Parameterization memory and Internet Explorer" on page 62.

The Inline controller has an integrated parameterization memory.

In addition, it is possible to use a plug-in parameterization memory in the form of an SD card. The SD card can be used as the main or additional memory of the Inline controller, refer to Section 3.7.

The SD card is optional and not required to operate the Inline controller.



NOTE: Parameterization memory (SD card) – formatting note

The SD card is already formatted and is intended for use with Phoenix Contact devices.

- Make sure that the SD card is not reformatted.



NOTE: Using the parameterization memory (SD card)

Only use a parameterization memory provided by Phoenix Contact (for ordering data, see Section "Accessories" on page 95).

2.9.1 Inserting/removing the parameterization memory

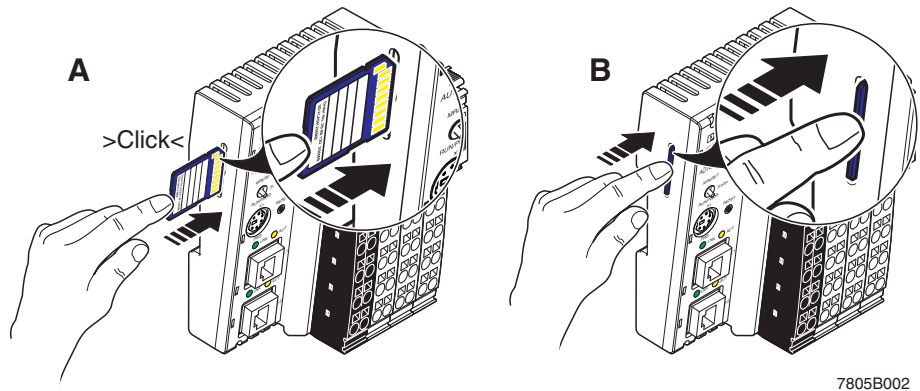

Figure 2-10 Inserting (A) and removing (B) the parameterization memory

Inserting the SD card

The Inline controller has an SD card holder with push/push technology.

- Insert the parameterization memory (SD card) into the slot as shown in Figure 2-10 (A).
- Gently push the parameterization memory into the slot until it engages with a click in the card holder.

Removing the SD card

- Gently push the parameterization memory into the slot in the direction shown in Figure 2-10 (B) until the snap-on mechanism releases the parameterization memory and partially ejects it from the slot. Remove the parameterization memory.



For additional information on the parameterization memory, please refer to Section “Functions of the plug-in parameterization memory (SD card)” on page 56 and Section “Parameterization memory and Internet Explorer” on page 62.

2.10 Internal basic circuit diagram

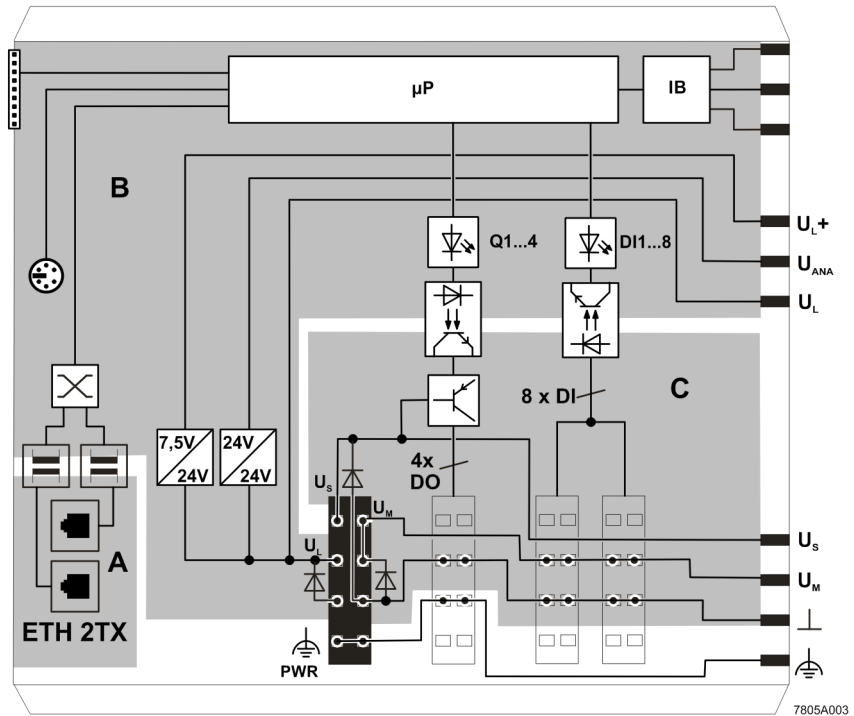













Figure 2-11 Internal basic circuit diagram (ILC 171 ETH 2TX)

Key:

| | | | |
|---|--|---|-----------------|
|  | Microprocessor |  | Inverter |
|  | Protocol chip |  | LED |
|  | RS-232 interface |  | Optocoupler |
|  | Transmitter |  | NPN transistor |
|  | RJ45 socket |  | Ethernet switch |
|  | SD card holder (the SD card is not supplied as standard) | | |

The gray areas in the basic circuit diagram represent electrically isolated areas:

- A: Ethernet interface
- B: Logic
- C: I/O



Other symbols used are explained in the IL SYS INST UM E user manual.

2.11 Mounting and removing the Inline controller



For notes and instructions on mounting and removing Inline terminals, please refer to the IB IL SYS PRO UM E user manual (for INTERBUS), the IL SYS INST UM E Inline installation manual or the Inline system manual for your bus system.



NOTE:

Before mounting or removing the controller, make sure that the supply voltage is switched off and cannot be switched on again by unauthorized persons.

An Inline station is set up by mounting the individual components side by side. No tools are required. Mounting the components side by side automatically creates potential and bus signal connections between the individual station components.

The controller is mounted perpendicular to the DIN rail.

Mounting location

Like all other terminals in the Inline product range, the Inline controller has IP20 protection and is designed for use in a closed control cabinet or control box (terminal box) with IP54 protection or higher.

DIN rail

The Inline controller is mounted on a 35 mm standard DIN rail.



Fix the DIN rail on which the Inline controller is mounted several times, especially in the area around the Inline controller. This makes it easier to remove the Inline controller.

End brackets

Mount end brackets on both sides of the Inline station. The end brackets ensure that the Inline station is correctly mounted. End brackets secure the Inline station on both sides and keep it from moving from side to side on the DIN rail. Phoenix Contact recommends using CLIPFIX 35-5 end brackets (Order No. 3022276).

End plate

The mechanical end of an Inline station is the end plate. It has no electrical function. It protects the station against ESD pulses and the user against dangerous contact voltages. The end plate is supplied together with the Inline controller and does not need to be ordered separately.



NOTE:

When mounting or removing the Inline controller it must be tilted. This means that no Inline terminal should be installed directly to the right of the Inline controller during mounting and removal. The terminal must be removed prior to mounting or removing the Inline controller. Otherwise, the snap-in hooks and jumper contacts will be damaged.

Mounting position

Mount the Inline controller horizontally (as shown in Figure 2-12 on page 29). The temperature range specified in Section "Ambient conditions" on page 93 is only guaranteed if the Inline controller is mounted in this position.



The Inline controller must only be mounted or removed within a temperature range from -5°C to +55°C (ILC 131 ETH, ILC 151 ETH, ILC 171 ETH 2TX, ILC 191 ETH 2TX) or from -5°C to +60°C (ILC 131 ETH/XC, ILC 151 ETH/XC).

Mounting

When mounting the Inline controller, proceed as shown in Figure 2-12 and Figure 2-13:

- Disconnect the power to the station.
- Place the Inline controller onto the DIN rail from above (Figure 2-12, A) and push down (Figure 2-12, B).
- Then attach all the electronics bases required to set up the station. Observe the information provided in the aforementioned user manuals.



Make sure that **all** featherkeys and keyways on adjacent terminals are securely interlocked.

- Once all the bases have been snapped on, insert the connectors in the corresponding bases.

First, place the front connector shaft latching in the front snap-on mechanism (Figure 2-13, A).

Then press the top of the connector towards the base until it snaps into the back snap-on mechanism (Figure 2-13, B).

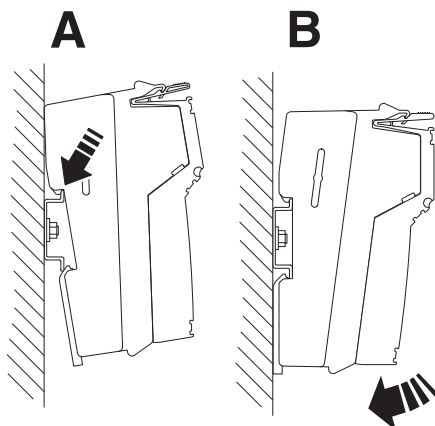

Figure 2-12 Snapping on the Inline controller (1)

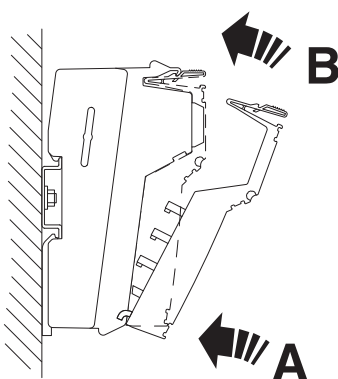

Figure 2-13 Snapping on the Inline controller (2)

ILC 1X1

Removal

When removing the Inline controller from the DIN rail, proceed as shown in Figure 2-15 on page 31:

- Disconnect the power to the station.



Unlike other Inline terminals, the Inline controller is removed by tilting it away from the DIN rail. This requires the Inline terminal to the right to be removed prior to removing the Inline controller. The right connector of the Inline controller must also be removed.

Remove the third and fourth connectors to access the right base latch.

It is therefore recommended that all connectors be removed prior to removing the Inline controller.

- If the connectors cause trouble during removal:
Remove all the connectors of the Inline controller.
 - Lever up each connector by pressing on the back connector shaft latching (Figure 2-15, A).
 - Remove the connectors (Figure 2-15, B).
- If Inline terminals are installed next to the Inline controller (see Figure 2-14):
 - Remove the following connectors:
 - All connectors of the terminal that is directly connected (A1 to A4)
 - The adjacent connector of the following terminal (B1)
 - Remove the directly adjacent Inline terminal (A).



Observe the information provided on Page 28 of the above user manuals.

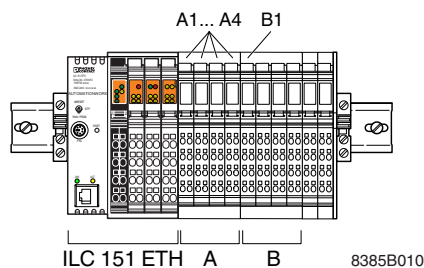

Figure 2-14 Connectors to be removed if terminals are installed next to the Inline controller

Description of the Inline controller

- Insert a tool in the base latches of the Inline controller and pull gently upwards (Figure 2-16, A). Pull out the Inline controller from the DIN rail (Figure 2-16, B, C).

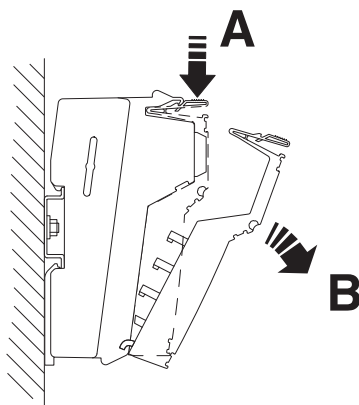

Figure 2-15 Removing the Inline controller (1)

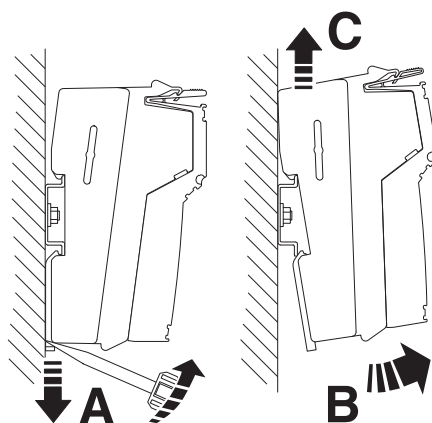

Figure 2-16 Removing the Inline controller (2)

Replacing an Inline controller

If you want to replace an Inline controller within an Inline station, proceed as described above (removing and mounting). Make sure that the terminal to the right is not installed when removing and mounting the Inline controller. Only reinstall this terminal once the Inline controller is mounted.



In particular, make sure that **all** featherkeys and keyways on adjacent terminals are securely interlocked.

Observe the following when replacing an Inline controller:
Enter the new MAC address when using the BootP server.

2.12 Communication paths

The communication path to the Inline controller must be determined before communication with the Inline controller can take place.

The following communication paths are available on the Inline controller:

**ILC 131 ETH, ILC 151 ETH,
ILC 131 ETH/XC,
ILC 151 ETH/XC:** (A1) 1 x Ethernet 10/100Base-T(X)

**ILC 171 ETH 2TX,
ILC 191 ETH 2TX:** (A2) 2 x Ethernet X2.1/X2.2: 10/100Base-T(X) (internally switched)

**ILC 131 ETH, ILC 151 ETH,
ILC 171 ETH 2TX,
ILC 191 ETH 2TX,
ILC 131 ETH/XC,
ILC 151 ETH/XC:** (B) PRG The serial interface of your PC is directly connected to the Inline controller (not for programming).

For additional information on using the serial interface (e.g., IP address assignment), please refer to Section "Serial PRG interface - function blocks" on page 35.



The Inline controller cannot be programmed via the RS-232 PRG interface.

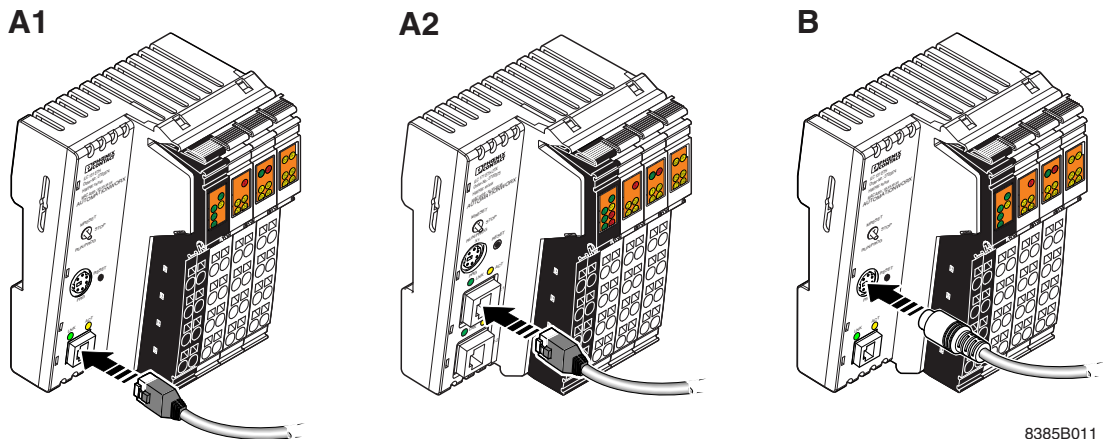

8385B011

Figure 2-17 Communication paths: (A1/A2) Ethernet (B) PRG

2.12.1 Ethernet

For connecting the Ethernet network, a standardized Ethernet interface is available on each of the ILC 131 ETH, ILC 151 ETH, ILC 131 ETH/XC and ILC 151 ETH/XC Inline controllers. Using the ILC 171 ETH 2TX and ILC 191 ETH 2TX Inline controllers, two standardized Ethernet interfaces (X2.1/X2.2) are provided for connection to the Ethernet network.

The Ethernet network is connected via RJ45 sockets.



Use an Ethernet cable which corresponds to CAT5 of IEEE 802.3 at least.
Observe the bending radii of the Ethernet cables used.

The contact assignment of the interface is as follows:

| | | |
|-----------------|-----|---|
| Transmit data + | T + | 1 |
| Transmit data - | T - | 2 |
| Receive data + | R + | 3 |
| - | | 4 |
| - | | 5 |
| Receive data - | R - | 6 |
| - | | 7 |
| - | | 8 |

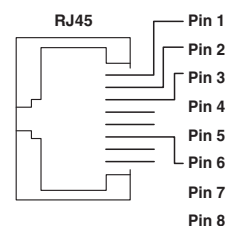
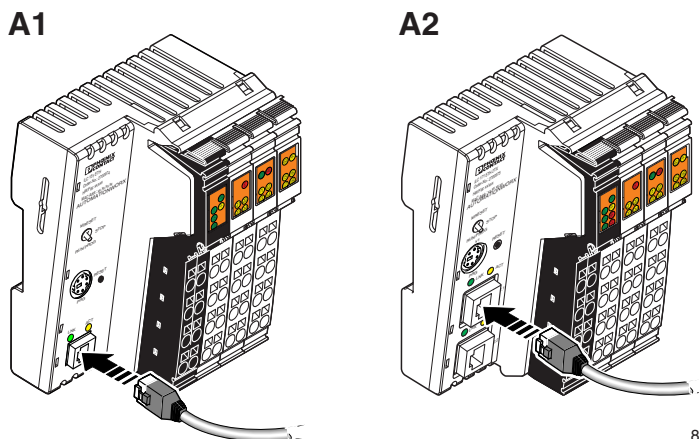

Figure 2-18 Ethernet interface



8385B012

Figure 2-19 Connecting the Ethernet cable to the Inline controller
A1: ILC 131 ETH, ILC 151 ETH, ILC 131 ETH/XC, ILC 151 ETH/XC
A2: ILC 171 ETH 2TX, ILC 191 ETH 2TX



The interface is able to switch over the transmitter and receiver automatically (auto cross-over).

2.12.2 Serial PRG interface (mini-DIN socket)

In addition to providing the Ethernet interface, this serial interface enables communication with the Inline controller from a PC.

A connecting cable is required for direct connection of the Inline controller to a PC with PC Worx via the serial PRG interface. Connect the connecting cable to the programming interface of the Inline controller (PRG designation) and the serial interface of the PC.



This interface can be used to **either** assign the IP address of the Inline controller and to access the Inline controller using the Diag+ diagnostics tool **or** to communicate with special I/O devices via function blocks (see Section 2.12.3, "Serial PRG interface - function blocks").

The Inline controller cannot be programmed via the RS-232 interface.

Assembly instruction

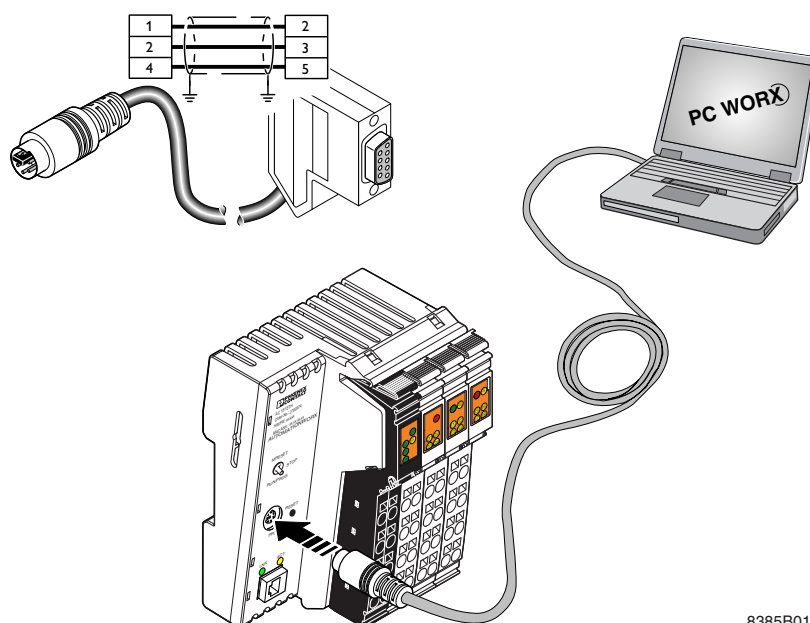

8385B013

Figure 2-20 Connecting cable between PC and Inline controller



Ordering data:
Connecting cable for connecting the Inline controller to a PC (RS-232) for PC Worx, length 3 m (Designation COM CAB MINI DIN, Order No. 2400127).

2.12.3 Serial PRG interface - function blocks

This interface can be used to:

- Assign the IP address or work with Diag+
- Communicate with input/output devices via function blocks

The following function blocks are available in the PC Worx/PC Worx Express software:

Table 2-2 Function block overview

| Function block | Short description |
|----------------|---|
| RS232_INIT | Parameterization of the serial interface. You can use this function block to specify the following parameters of the serial interface: <ul style="list-style-type: none"> - Protocol: transparent - Baud rate: 1200, 2400, 4800, 9600, 19200, 38400, 57600 or 115200 - Data width: 8 data bits, even parity - Number of stop bits: 1 - Hardware flow control: not supported |
| RS232_RECEIVE | Reading the internal receive memory of the serial interface. |
| RS232_SEND | Data transmission to the internal transmit memory of the serial interface. |

Once the RS232_INIT function block has been activated, the interface is parameterized accordingly so that it is only possible to communicate with the connected input or output devices.

Deactivating the RS232_INIT function block or performing another cold restart or warm start enables the IP address to be assigned and the controller to be accessed with Diag+.



For additional information on the function blocks, please refer to the online help for the PC Worx/PC Worx Express software.

I/O devices that can be connected

Various I/O devices (e.g., modem, printer, barcode scanner) can be connected to the Inline controller via the serial PRG interface. The connected devices are addressed from the application program using function blocks.

2.13 INTERBUS



The descriptions for INTERBUS apply to all Inline controllers listed on the inner cover page of this user manual.



Observe the information in the “Configuring and installing the INTERBUS Inline product range” user manual IB IL SYS PRO UM E when creating an Inline system (local bus and/or remote bus).



Please note that the Inline controller does not support the following functions:

- Switching of devices
- Single-channel diagnostics
- Fiber optic diagnostics/optical regulation
- Logical addressing

Only INTERBUS devices with SUPI 3 and SUPI 3 OPC protocol chip or later can be used with INTERBUS as local bus/remote bus devices.

2.13.1 Local bus

The local bus is automatically created by directly connecting I/O modules to the Inline controller.

2.13.2 Remote bus



Please note: the ILC 131 ETH and ILC 131 ETH/XC controllers do not support connection of the INTERBUS remote bus.

Connect the remote bus to the Inline Controller using the IBS IL 24 RB-T-PAC branch terminal (Order No. 2861441; including accessories).



The **first branch terminal** must always be placed directly after the Inline controller. In terms of topology, it opens a **remote bus**.

If **additional branch terminals** are used after the first branch terminal, they must be installed directly one after the other (see also notes in the terminal-specific data sheet). In terms of topology, the additional branches are **remote bus branches** with the branch terminal being the first device in the corresponding remote bus branch.

A maximum of 3 branch terminals can be connected to the Inline controller, each of which opens a remote bus (see Figure 2-3 on page 14).

2.14 Power supply



The descriptions for the power supply apply to all the Inline controllers listed on the inner cover page of this user manual.

2.14.1 Sizing of the power supply

Choose a power supply unit that is suitable for the currents in your application. The selection depends on the bus configuration, the resulting maximum currents, and the type of supply (separate supply of U_{ILC} , U_M , and U_S , or supply from a power supply unit).



A power supply without a fall-back characteristic curve must be used for correct operation of the Inline controller (see Figure 2-22). When the Inline controller is switched on, an increased switch-on current is temporarily triggered. The Inline controller behaves like a capacitive load when it is switched on.

Some electronically controlled power supplies have a fall-back characteristic curve (see Figure 2-21). They are not suitable for operation with capacitive loads.

A primary-switched power supply (without fall-back characteristic curve) from the QUINT POWER series (see current catalog from Phoenix Contact) is recommended for Inline controller operation.

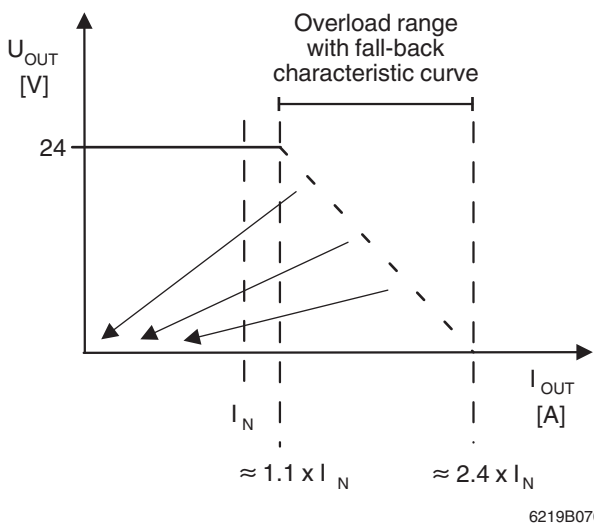

Figure 2-21 Overload range **with** fall-back characteristic curve

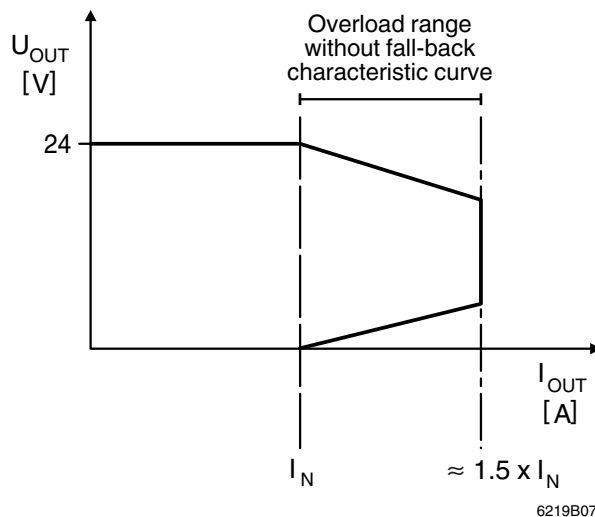

Figure 2-22 Overload range **without** fall-back characteristic curve

2.14.2 Connecting the power supplies

Supply the Inline controller using external 24 V DC voltage sources. The permissible voltage ranges from 19.2 V DC to 30 V DC (ripple included).



Only use power supplies that are suitable for operation with capacitive loads (increased switch-on current) (see Section "Sizing of the power supply" on page 37).

1. Connect the power supplies to the connector for power supply as shown in Figure 2-23.
2. Insert the connector in the Inline controller.
3. Switch on the power supplies.
4. The UL, UM, and US LEDs light up and, after around 10 seconds, the FR and RDY LEDs start flashing.

The Inline controller is now fully initialized.

If the LEDs do not light up or start flashing, there is a serious fault on the Inline controller. In this case, please contact Phoenix Contact.

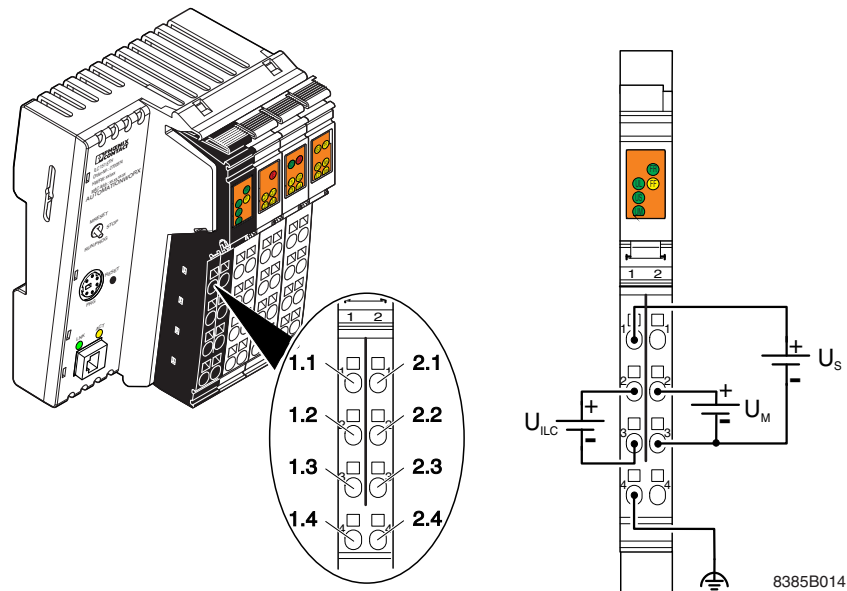





Figure 2-23 Supply voltage connection

Description of the Inline controller

| Terminal point | Assignment | | Note |
|----------------|-----------------------------|------------------------------------|---|
| Connector 1 | Power connectors | | |
| 1.1 | 24 V DC (U _S) | 24 V segment voltage supply | The supplied voltage is directly routed to the potential jumper.  NOTE: Protect the supply voltage externally according to the connected load (local bus devices) with 8 A, maximum . Make sure the external fuse blows in the event of an error. |
| 1.2 | 24 V DC (U _{ILC}) | 24 V supply | The 7.5 V communications power (U _L) for the ILC and the connected local bus devices is generated from this voltage. The 24 V analog voltage (U _{ANA}) for the local bus devices is also generated.  NOTE: Protect the supply voltage externally according to the connected load (local bus devices) with 2 A, maximum . Make sure the external fuse blows in the event of an error. |
| 2.1, 2.2 | 24 V DC (U _M) | 24 V main voltage supply | The main voltage is routed to the local bus devices via the potential jumpers.  NOTE: Protect the supply voltage externally according to the connected load (local bus devices) with 8 A, maximum . Make sure the external fuse blows in the event of an error. |
| 1.3 | LGND | Logic ground reference potential | The potential serves as the reference ground for the communications power. |
| 2.3 | SGND | Segment ground reference potential | The reference potential is directly routed to the potential jumper and is, simultaneously, reference ground for the main and segment supply. |
| 1.4, 2.4 | FE | Functional earth ground (FE) | Functional earth ground must be connected through the power supply. The contacts are directly connected to the potential jumper and FE springs on the bottom of the housing. The Inline controller is grounded when it is snapped onto a grounded DIN rail. Functional earth ground is only used to discharge interference. |

**NOTE:**The **maximum total current** flowing through the potential jumpers is **8 A**.

2.14.3 24 V segment supply/24 V main supply

The segment supply and main supply must have the same reference potential. An electrically isolated voltage area is not possible.

2.14.4 24 V segment supply

There are several ways of providing the segment voltage at connector 1:

1. The segment voltage can be supplied separately at terminal points 1.1 and 2.3 (GND) (see Figure 2-23 on page 38).
2. Connections 1.1 and 2.1 (or 2.2) can be jumpered to ensure that the segment circuit is supplied from the main circuit.
3. A switched segment circuit can be created with a switch between terminal points 1.1 and 2.1 (or 2.2).



NOTE:

The 24 V segment supply has elements for protection against polarity reversal and transient surge voltage.

It does not have short-circuit protection.

The user must provide short-circuit protection. The rating of the fuse connected upstream must be such that the maximum permissible load current of 8 A is not exceeded (total current at U_M and U_S).

2.14.5 24 V main voltage



NOTE:

The 24 V main supply has elements for protection against polarity reversal and transient surge voltage.

It does not have short-circuit protection.

The user must provide short-circuit protection. The rating of the fuse connected upstream must be such that the maximum permissible load current of 8 A is not exceeded (total current at U_M and U_S).

2.14.6 24 V ILC supply



NOTE:

The 24 V ILC supply has elements for protection against polarity reversal and transient surge voltage. These protective elements are only used to protect the power supply unit.

The rating of the fuse connected upstream must be such that the maximum permissible load current of 2 A is not exceeded.

2.14.7 Jumpering



Terminals 1.3 and 2.3 on connector 1 can be jumpered if the communications power and the segment voltage are not to be electrically isolated.

2.15 Digital inputs and outputs



The descriptions for digital inputs and outputs apply to all the Inline controllers listed on the inner cover page of this user manual.

There are eight 24 V DC inputs and four 24 V DC outputs.

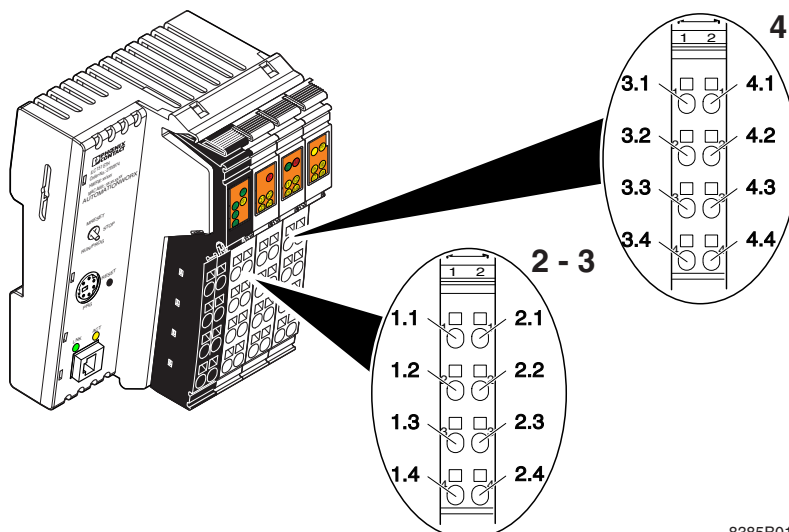

8385B015

Figure 2-24 Assignment of terminal points of connectors 2 to 4

Table 2-3 Terminal point assignment

| Terminal point | Assignment | Note |
|--|------------|---|
| Connector 2 Output terminal points | | |
| 1.1 | Q1 | Output 1 |
| 2.1 | Q2 | Output 2 |
| 1.2, 2.2 | GND | Ground connection for 2 and 3-conductor connection |
| 1.3, 2.3 | FE | Functional earth ground for 3-conductor connection |
| 1.4 | Q3 | Output 3 |
| 2.4 | Q4 | Output 4 |
| The outputs are supplied with 24 V DC from the segment supply (U_S). | | |
| Connector 3 Input terminal points | | |
| 1.1 | I1 | Input 1 |
| 2.1 | I2 | Input 2 |
| 1.2, 2.2 | 24 V | Supply voltage U_M for 2 and 3-conductor connection |
| 1.3, 2.3 | GND | Ground connection for 3-conductor connection |
| 1.4 | I3 | Input 3 |

ILC 1X1

Table 2-3 Terminal point assignment [...]

| Terminal point | Assignment | Note |
|--------------------|------------------------------|---|
| 2.4 | I4 | Input 4 |
| Connector 4 | Input terminal points | |
| 3.1 | I5 | Input 5 |
| 4.1 | I6 | Input 6 |
| 3.2, 4.2 | 24 V | Supply voltage U_M for 2 and 3-conductor connection |
| 3.3, 4.3 | GND | Ground connection for 3-conductor connection |
| 3.4 | I7 | Input 7 |
| 4.4 | I8 | Input 8 |



The inputs are supplied with 24 V DC from the main supply (U_M).



The outputs have protection against ground connection interrupt and must be wired accordingly.

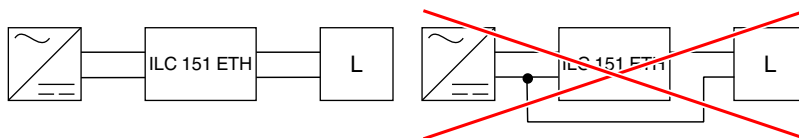

8385B016

Figure 2-25 Basic wiring of an output with a load (L)
(shown using the ILC 151 ETH as an example)



Phoenix Contact recommends that connectors for digital 4-channel or 16-channel Inline terminals are used to connect sensors or actuators in 3-wire technology (not supplied as standard, see Section “Accessories” on page 95).

3 The Inline controller under PC Worx/PC Worx Express

3.1 Software version

Using the Inline controller requires the following PC Worx/PC Worx Express version or later:

Table 3-1 Software version information

| Inline controller | Firmware version | | |
|-------------------|--|-----------------|----------------------------------|
| | ≥ 4.0 | | |
| | Software versions (Service Pack = SP, Hotfix = HF) | | |
| | PC Worx | PC Worx Express | AUTOMATIONWORX Software Suite |
| ILC 131 ETH | ≥ 6.20 | | 2012 1.70 |
| ILC 151 ETH | ≥ 6.20 | | 2012 1.70 |
| ILC 171 ETH 2TX | ≥ 6.20 SP 1 | | 2012 1.70 SP 1 |
| ILC 191 ETH 2TX | ≥ 6.20 SP 1 | | 2012 1.70 SP 1 |
| ILC 131 ETH/XC | ≥ 6.20 | | 2012 1.70 |
| ILC 151 ETH/XC | ≥ 6.20 | | 2012 1.70 |

PROFINET device function



The PROFINET device function of these controllers is not supported by the PC Worx Express software.



For information on installing and using PC Worx/PC Worx Express, please refer to the corresponding quick start guide. It can be downloaded at phoenixcontact.net/products and is supplied with the software.

3.2 Creating a new project

Before making the settings described below, create a new project in the PC Worx/PC Worx Express software.

- Select the “New Project...” command from the “File” menu to create a new project using a template.
- In the “New Project” dialog, select the “ILC 1...” template according to the version of the Inline controller you are using.
- Save the project using an appropriate name (in the example in Figure 3-1: “UM_ILC_1X1”).

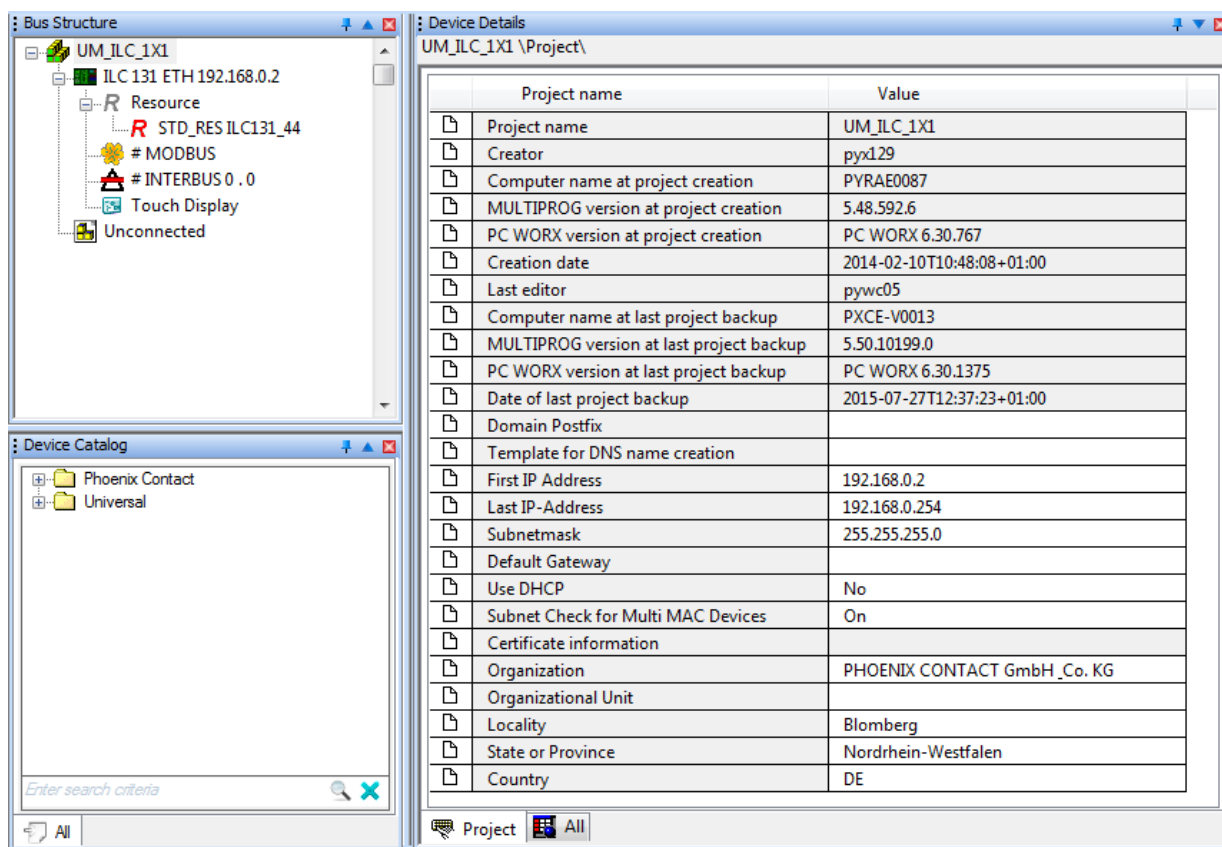

Figure 3-1 Project information after creating a new project

3.3 Assigning the IP address for the controller



The procedure for assigning the IP address is essentially the same in PC Worx and PC Worx Express for all Inline controllers described in this user manual.

By default, the Inline controller has no preset IP address. Initial setting of the IP address can be carried out with the PC Worx/PC Worx Express software manually via the serial interface, using the DCP protocol, or by means of a BootP server. The IP address can be changed later with the PC Worx/PC Worx Express software via the serial connection, Ethernet, or the DCP protocol.

3.3.1 Dynamic Configuration Protocol (DCP)



The Inline controllers support the DCP protocol from firmware version 4.20 or later and from PC Worx version 6.30.767 or later (part of the AUTOMATIONWORX Software Suite 1.81 including AddOn V1).

The IP address is assigned via the DCP protocol in the PC Worx/PC Worx Express software via the “Device Details” window:

- Select the “IP Settings” tab.
- Enter the IP address of the Inline controller.

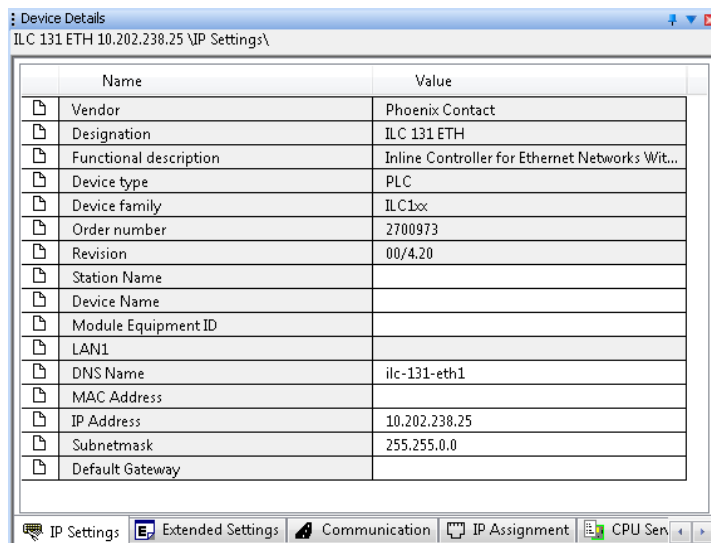

Figure 3-2 DCP: setting the IP address

The “IP Assignment” tab is used for the actual IP address assignment with DCP.

- Select the “IP assignment” tab.

After selecting the “IP Assignment” tab, the PROFINET network is searched for DCP devices.

- Click on “Assign IP” to start IP address assignment with DCP.

ILC 1X1

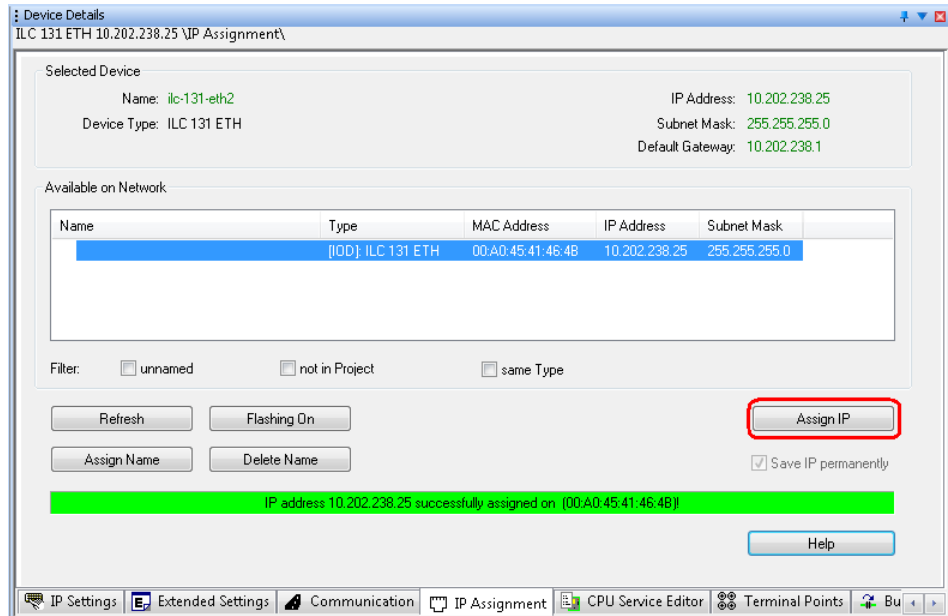

Figure 3-3 Starting IP address assignment via DCP

A green status indicator indicates successful IP address assignment.

The PROFINET device name is assigned in the same way.

3.3.2 BootP server

The following example describes IP address assignment using a BootP server in PC Worx Express for the ILC 151 ETH.

Bootstrap protocol (BootP)

In an Ethernet network, BootP is used to assign an IP address to a BootP client using a BootP server. For this example (delivery state of the ILC 151 ETH), the ILC 151 ETH (BootP client) sends a Boot_Request as a broadcast in the network. The MAC address of the transmitter is sent with the Boot_Request to provide unique identification. If the BootP server has been activated in PC Worx Express, PC Worx Express responds with a Boot_Reply. PC Worx Express uses this Boot_Reply to inform the ILC 151 ETH of its IP address and subnet mask. Please ensure that:

- The BootP server knows the MAC address sent by the BootP client.
- A corresponding IP address and subnet mask have been assigned in PC Worx Express for the MAC address.

Once the IP data has been transferred to the ILC 151 ETH successfully, PC Worx Express sends a corresponding acknowledgment message.

The Inline controller under PC Worx/PC Worx Express

PC/network adapter

To determine whether your network permits the IP settings used in the example project (see Figure 3-4 on page 47), proceed as follows:

- In the Windows Control Panel, check the settings for your PC network adapter.
- If necessary, adjust these settings so that the ILC 151 ETH can be accessed in your network via the IP address used in the example project.

If your network does not permit the use of the IP address used in the example project, adjust the settings in the project information accordingly (see Figure 3-1 on page 44).



Changes to project information are not applied automatically

If any modifications are made to the project information (see Figure 3-1) that affect the IP settings for the controller, a warning is displayed. However, the modification is not implemented automatically.

When a new project is created, the default settings are specified under “IP Settings”.

Assigning IP settings

To set the IP address in PC Worx/PC Worx Express, proceed as described below.



Please note that BootP is preset on the Inline controller by default.



The IP address that is assigned here for the controller is also implemented as the IP address for the communication path via TCP/IP.



After assigning the IP address, PC Worx Express automatically creates a link via TCP/IP as a communication path to the Inline controller.

- Establish an Ethernet connection between your PC and the controller.
- Switch to the bus configuration workspace.
- Select the controller node (in the example: “ILC 151 ETH”).
- In the “Device Details” window, select the “IP Settings” tab.
- Enter the MAC address of the controller (see Figure 3-4). It is printed on the device (“00.A0.45.xx.xx.xx”).

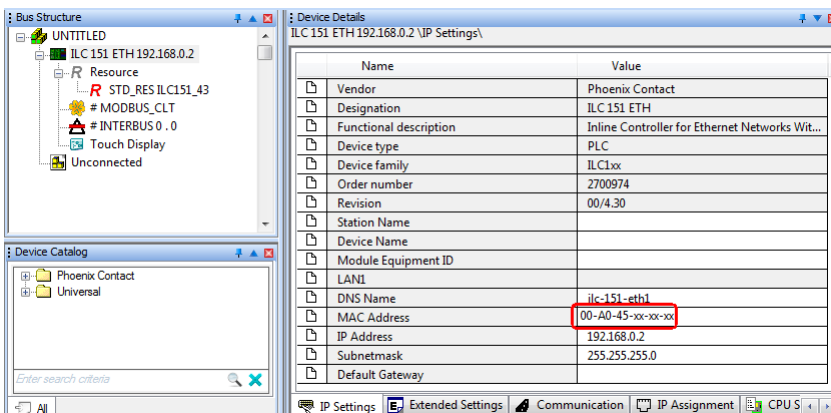
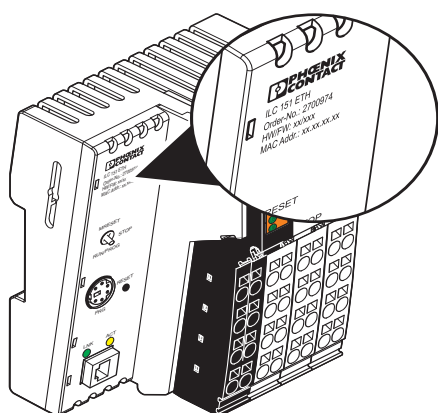

Figure 3-4 Entering the MAC address

- In the PC Worx Express menu bar, select the “Extras, BootP/SNMP/TFTP-Configuration...” menu.

ILC 1X1

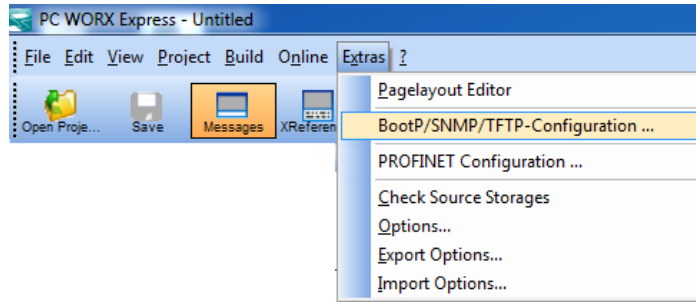

Figure 3-5 “Extras, BootP/SNMP/TFTP-Configuration...” menu

- Click on the “Activate BootP” button.

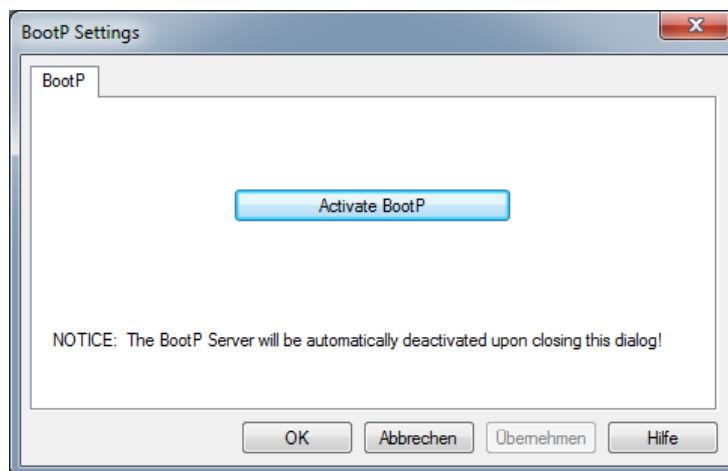

Figure 3-6 “Activate BootP” button

- Perform a cold restart for the controller. To do this, switch the supply voltage off and then on again after about 2 seconds.

The controller is assigned the IP address which is specified in the project for the controller. The following message appears in the message window in the “Bus Configurator” tab.

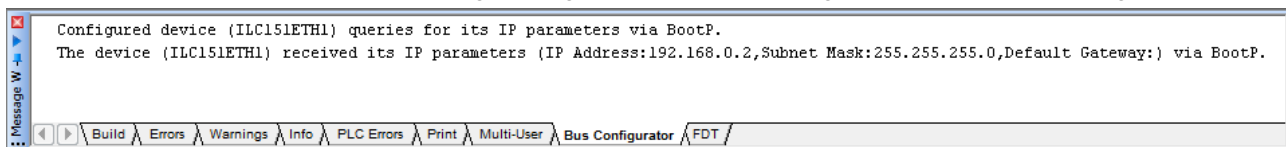

Figure 3-7 Message window following BootP

The IP address is now permanently stored on the controller's internal parameterization memory.



For additional information on setting the IP address with PC Worx/PC Worx Express, please refer to the quick start guides for the software used.

3.4 The Inline controller as a PROFINET device



Please note that it is only possible to integrate the Inline controller into the **PC Worx** software as a **PROFINET device**.

The PROFINET device function of the Inline controller can also be activated in the PC Worx Express software.

This section uses an example to describe how to integrate the ILC 131 ETH as a PROFINET device. This procedure applies to all the Inline controllers listed in Section Section 1.1.



The PROFINET-specific system variables can be found in Section 4.5 on page 82.

Activating the PROFINET device function of the ILC 131 ETH

You can activate the PROFINET device function once you have assigned an IP address for the ILC 131 ETH as described in Section “Assigning the IP address for the controller” on page 45 (in the following example: 192.168.161.155).

- In the “Device Details” window, select the “PROFINET device activation” item under “Extended Settings”.
- Under “Settings”, select “PROFINET device activated”.

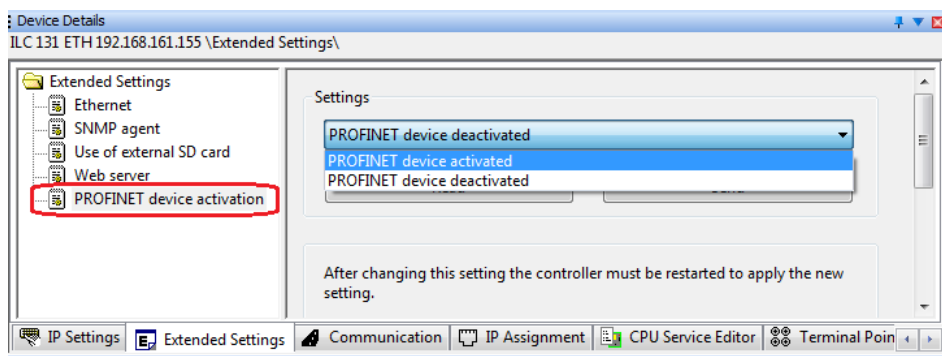

Figure 3-8 Switching on the PROFINET device function

- Click “Send” (hidden by the drop-down list in Figure 3-8).
- In the “Settings Communication Path” dialog, confirm the suggested IP address or the one you have set according to your application with “OK”.

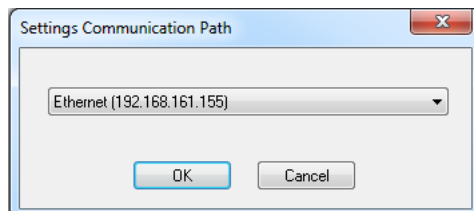

Figure 3-9 “Settings Communication Path” dialog

ILC 1X1

Successful execution of the service will be displayed in the status window.

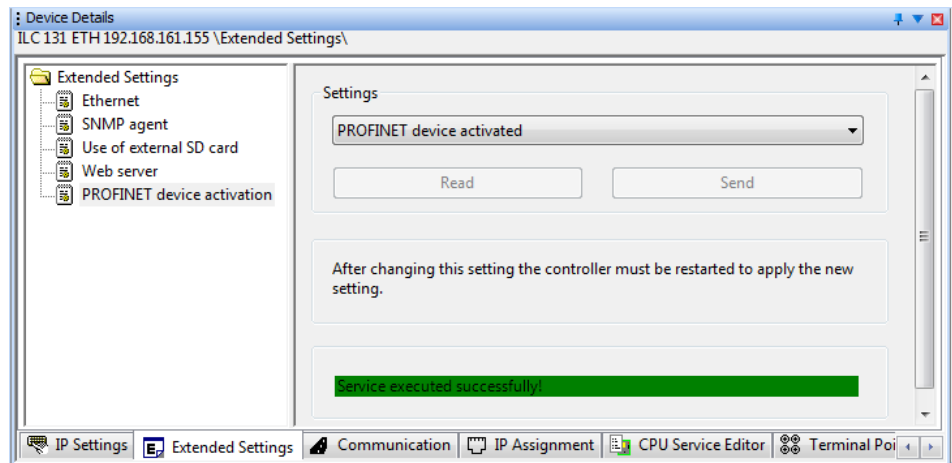

Figure 3-10 PROFINET device function/settings - Send: Service executed successfully

To apply the network settings, you have to restart the controller.

- In the "Device Details" window, select the "Ethernet" setting under "Extended Settings" (refer to Figure 3-11).
- In the "Activate Network Settings" area, click on the "Restart Controller" button (see Figure 3-11).

The Inline controller under PC Worx/PC Worx Express

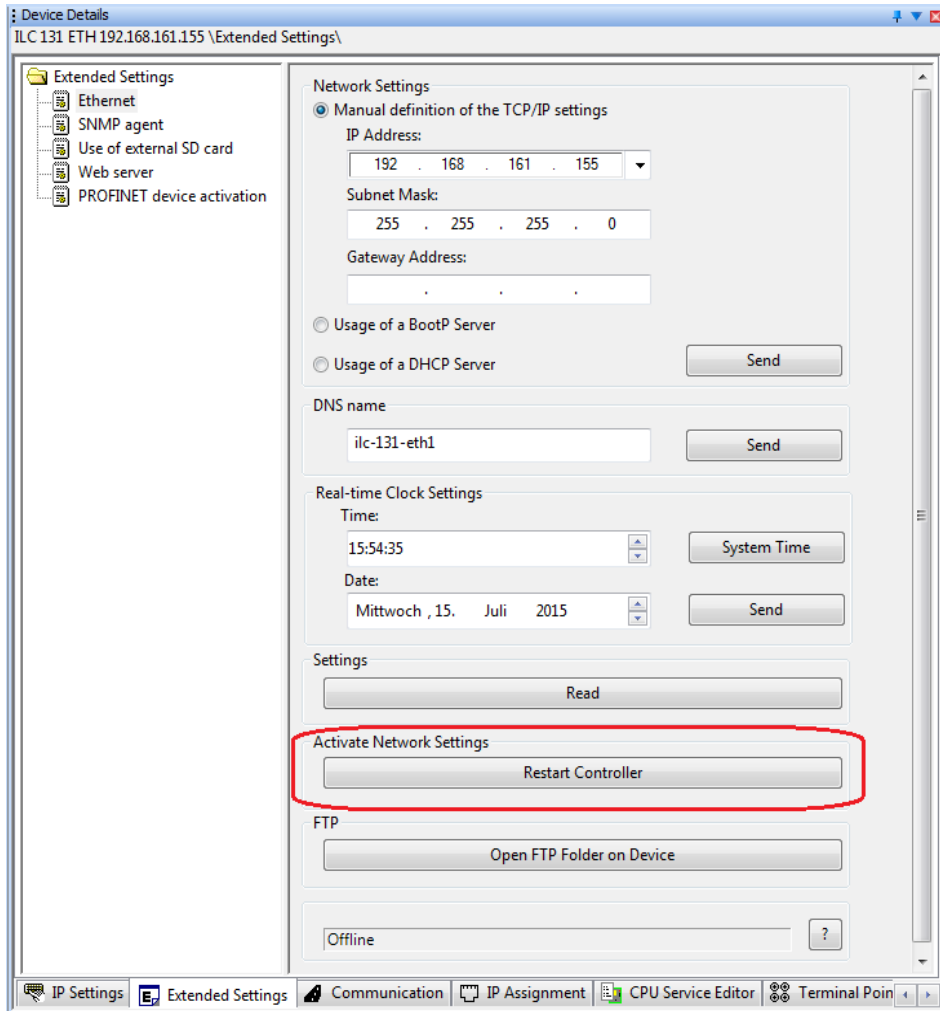

Figure 3-11 Activate Network Settings: Restart Controller

- In the “Settings Communication Path” dialog, confirm the suggested IP address or the one you have set according to your application with “OK”.

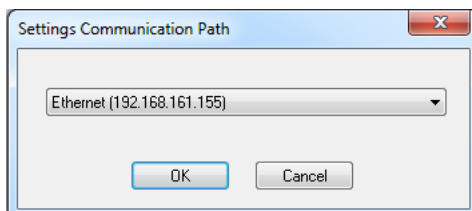

Figure 3-12 “Settings Communication Path” dialog

ILC 1X1

Successful execution of the service will be displayed in the status window.

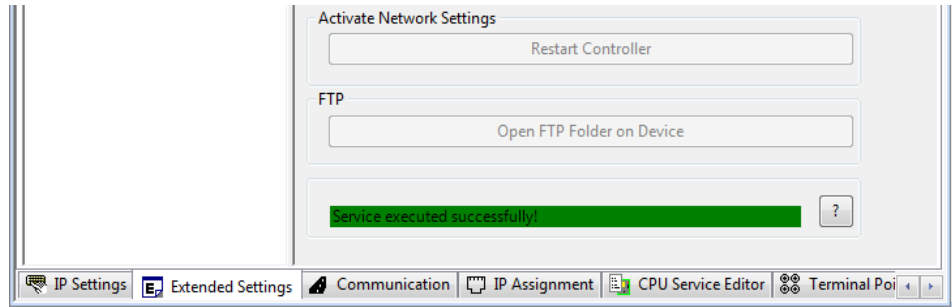

Figure 3-13 Activating the network settings: service executed successfully

Now you can read in the ILC 131 ETH as a PROFINET device in a PC Worx project.

Integrating the ILC 131 ETH as a PROFINET device



The following section describes how to read in the ILC 131 ETH as a PROFINET device in the PC Worx software.

Alternatively, you can also create the PC Worx project by selecting devices from the device catalog. For additional information on creating a PC Worx project, please refer to the online help or the quick start guide for the software.

The following conditions apply for the example project:

- Higher-level controller: AXC 1050
- Controller settings:
 - IP address: 192.168.161.162
 - Subnet mask: 255.255.255.0
 - PROFINET device name ("DNS name") axc-10501
- Settings of the ILC 131 ETH as a PROFINET device:
 - IP address: 192.168.161.155
 - Subnet mask: 255.255.255.0
 - PROFINET device name ("DNS name") ilc131eth

You can read in the ILC 131 ETH as a PROFINET device after you have done the following:

- Activated the PROFINET device function of the ILC 131 ETH
- Installed the PROFINET controller and the PROFINET devices (ILC 131 ETH and other PROFINET devices according to your application)
- Created a project in PC Worx and
- Configured the PROFINET controller according to your application.
- In the "Bus Structure" window, select the "Read PROFINET..." setting in the PROFINET context menu.

The Inline controller under PC Worx/PC Worx Express

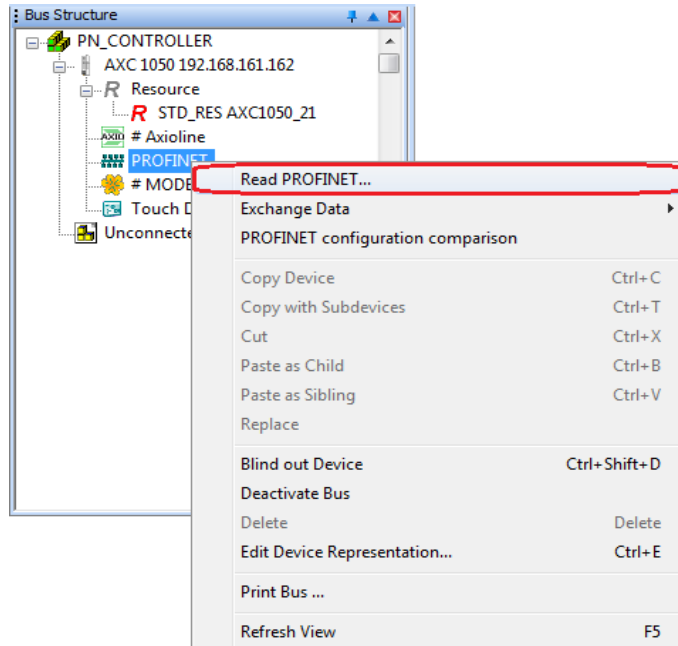

Figure 3-14 Bus Structure: PROFINET context menu “Read PROFINET...”

The “Read PROFINET” dialog that opens shows the PROFINET devices that have been detected in the connected network.

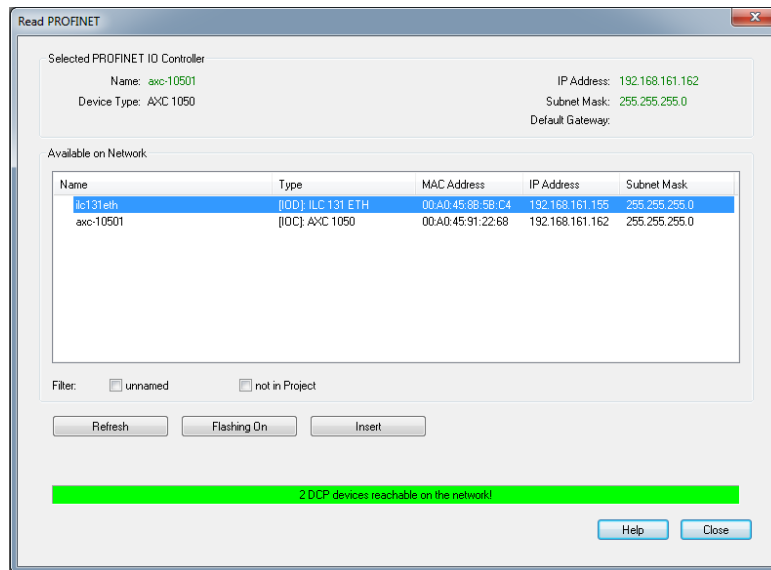

Figure 3-15 “Read PROFINET” dialog

- Select the ILC 131 ETH and insert it as a PROFINET device by clicking “Insert”.
- Close the dialog by clicking on the “Close” button.

ILC 1X1

The PROFINET device inserted earlier will be displayed in the “Bus Structure” window.

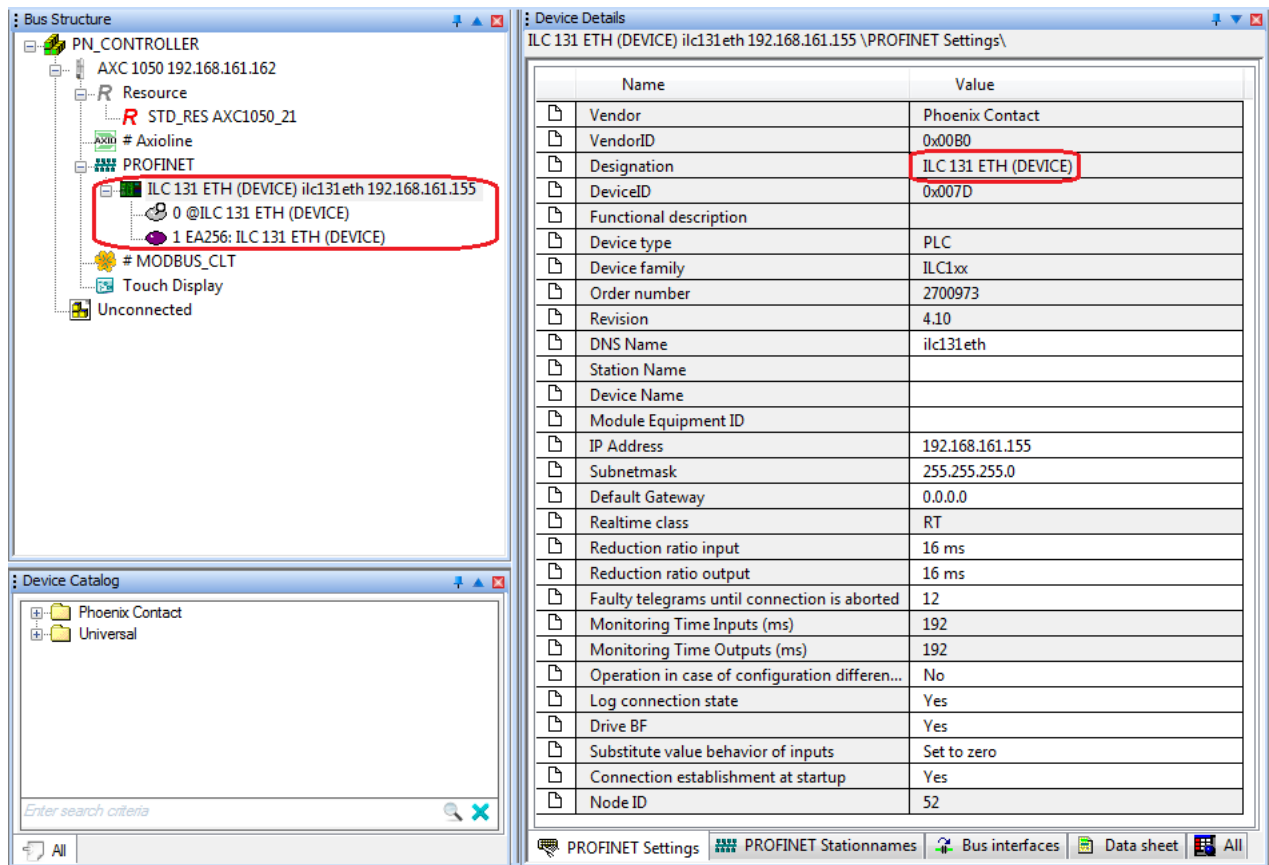

Figure 3-16 ILC 131 ETH inserted as a PROFINET device

The process data of the PROFINET device will be displayed on the “Process Data” tab in the “Device Details” window.

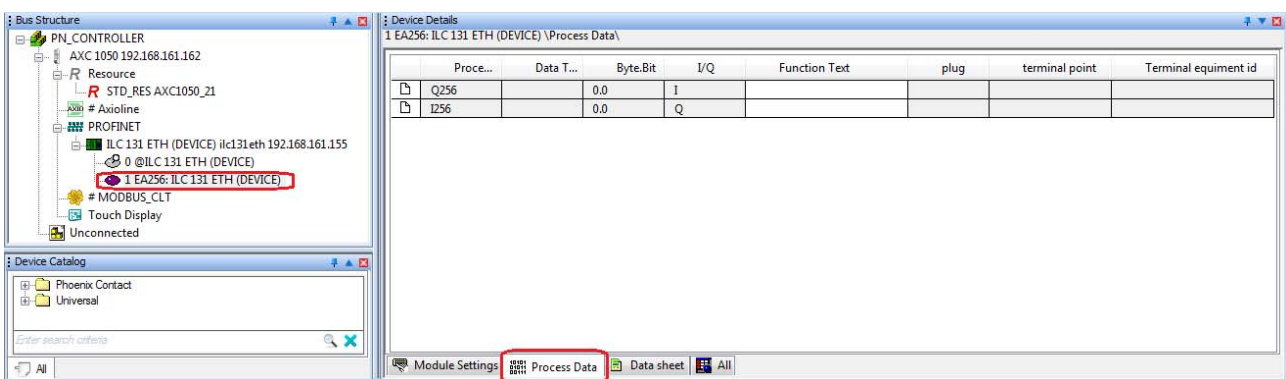

Figure 3-17 ILC 131 ETH as a PROFINET device: Process Data

The ILC 131 ETH is now available as a PROFINET device in the PC Worx project.

3.5 Setting the realtime clock under PC Worx Express



The procedure for setting the realtime clock is essentially the same in PC Worx and PC Worx Express. The following example describes the setting in PC Worx Express.

The time and date for the internal system clock of the Inline controller can be set under “Extended Settings” in the “Device Details” window for the controller in PC Worx Express.



To set the realtime clock, proceed as described in the quick start guide for the PC Worx Express version used.

3.6 Download changes

The “Download Changes” function supports the following Inline controllers from the specified device versions together with the specified versions of the PC Worx/PC Worx Express software tools.

Table 3-2 Version information for “Download Changes”

| Inline controller | Firmware version | PC Worx/PC Worx Express |
|-------------------|------------------|-------------------------|
| ILC 131 ETH | ≥ 4.00 | ≥ 6.20 |
| ILC 151 ETH | ≥ 4.00 | ≥ 6.20 |
| ILC 171 ETH 2TX | ≥ 4.00 | ≥ 6.20 Service Pack 1 |
| ILC 191 ETH 2TX | ≥ 4.00 | ≥ 6.20 Service Pack 1 |
| ILC 131 ETH/XC | ≥ 4.00 | ≥ 6.20 |
| ILC 151 ETH/XC | ≥ 4.00 | ≥ 6.20 |

3.7 Functions of the plug-in parameterization memory (SD card)



The function is available for Inline controllers with firmware versions ≥ 4.40 as of AUTOMATIONWORX Software Suite Version 1.82 AddOn V1.

The plug-in parameterization memory can be used as a main or additional memory.

Figure 3-18 shows how to proceed to use the SD card as the main or additional memory.

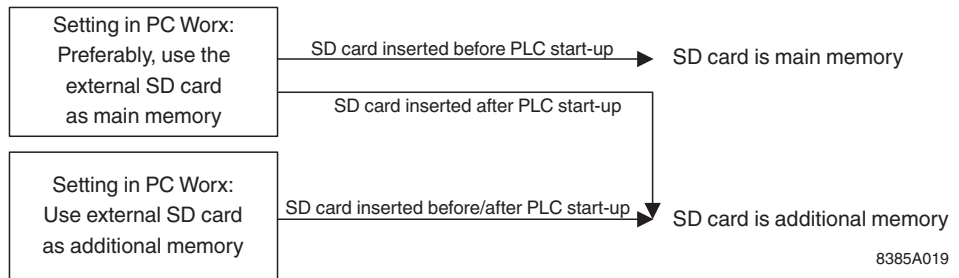

Figure 3-18 Procedure for using the external SD card as main or additional memory

Information on using the SD card as main or additional memory can be found in the following sections.

3.7.1 Main memory



The function is available for Inline controllers with firmware versions ≥ 4.40 as of AUTOMATIONWORX Software Suite Version 1.82 AddOn V1.

If the SD card is used as the main memory, all application-specific data is stored on the SD card.

The SD card is recognized during initialization of the Inline controller.

- Ensure that the SD card is inserted **before switching on the controller**, if it is to be used by the controller as the main memory.

Removing the SD card during operation



The SD card must not be removed while the Inline controller is in operation.

NOTE: Potential data loss

If you remove the SD card during operation, this could cause data loss.

- Do not remove the SD card during operation.

Should the SD card be accidentally removed during operation, the Inline controller will report an error, stop processing the application program, and switch to the READY state. The FAIL LED indicates an error. If an online connection to PC Worx is established, the message window will indicate that the SD card was unintentionally inserted or removed.

Changing operating modes

To change operating modes (operating the Inline controller with/without SD card), please note the following:

The Inline controller under PC Worx/PC Worx Express

Change: operation without SD card → operation with SD card

To change the Inline controller mode from “operation without SD card” to “operation with SD card”, proceed as follows:

- Switch off the supply voltage of the Inline controller.
- Insert the SD card, see Section 2.9.1 “Inserting/removing the parameterization memory”.
- Switch on the supply voltage of the Inline controller.



NOTE: Delete all data on the internal parameterization memory

When the Inline controller is switched on, all application-specific data is deleted from the internal parameterization memory. PC Worx projects and IP configurations stored on the parameterization memory are no longer available.

The Inline controller accesses the data stored on the SD card.

Change: operation with SD card → operation without SD card

To change the Inline controller mode from “operation with SD card” to “operation without SD card”, proceed as follows:

- Switch off the supply voltage of the Inline controller.
- Remove the SD card, see Section 2.9.1 “Inserting/removing the parameterization memory”.
- Switch on the supply voltage of the Inline controller.



NOTE: No data on the internal parameterization memory

Once the Inline controller has been operated with the SD card, there is no data available on the internal parameterization memory. The Inline controller therefore does not have an IP address.

- Assign the Inline controller an IP address as described in Section Section 3.3.

Settings in PC Worx

Figure 3-19 shows the settings in PC Worx required to use the SD card as the main memory.

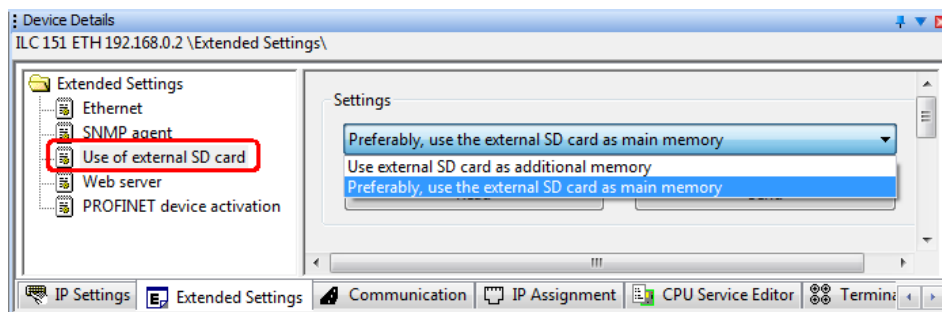

Figure 3-19 Setting the SD card as main memory

- In the “Device Details” window, select the “Use of external SD card” setting under “Extended Settings”.
- In the “Settings” area, in the drop-down list, select the setting “Preferably, use the external SD card as main memory”.
- Click “Send” (hidden by the drop-down list in Figure 3-19), to send the setting to the Inline controller.
- Restart the Inline controller.

Default setting

The setting “Preferably, use the external SD card as main memory” is activated by default in PC Worx.

If you do not change this setting, the following applies:

- If the SD card is **already inserted before starting up** the Inline controller (also refer to Figure 3-18 on page 56), the SD card is used as the **main memory**. All application-specific data is stored on the SD card.
- If the SD card is **only inserted after starting up** the Inline controller (also refer to Figure 3-18 on page 56), the SD card is used as an **additional memory** (also refer to Section 3.7.2). All application-specific data is stored on the internal parameterization memory of the Inline controller.

3.7.2 Additional memory



The function is available for Inline controllers with firmware versions ≥ 4.40 as of AUTOMATIONWORX Software Suite Version 1.82 AddOn V1.



WARNING: Explosion hazard

In potentially explosive areas, the SD card must not be used as additional memory. Use the SD card as main memory only. Don't insert or remove the SD card during operation.

If the SD card is used as an additional memory, all application-specific data is stored on the internal parameterization memory of the Inline controller. If an SD card with license key is used, the license is used despite this.



NOTE: In some circumstances, function blocks are no longer executed

If an SD card with license keys for the function block libraries (SD FLASH XXX APPLIC A) is removed from the Inline controller for longer than 60 minutes, function blocks that are required to execute a license are required may no longer be executed. If the SD card is removed and then inserted once again in the Inline controller before 60 minutes have passed, all function blocks will continue to run.

- Never remove an SD card with license keys for function block libraries from the Inline controller for longer than 60 minutes.

Use as additional memory

The SD card is used as an additional memory (also refer to Figure 3-18 on page 56), if

- The SD card is inserted **after starting up** the Inline controller
- or
- The setting “Use external SD card as additional memory” (default setting) has been selected in PC Worx.

Inserting/removing the SD card

The SD card can be inserted or removed before starting up or while the Inline controller is operating.



NOTE: Potential data loss

If you remove the SD card while read and/or write access to the SD card is activated, this could cause data loss.

- Only remove the SD card when it is not being accessed.

The Inline controller under PC Worx/PC Worx Express

Settings in PC Worx

Figure 3-20 shows the settings in PC Worx required to use the SD card as the additional memory.

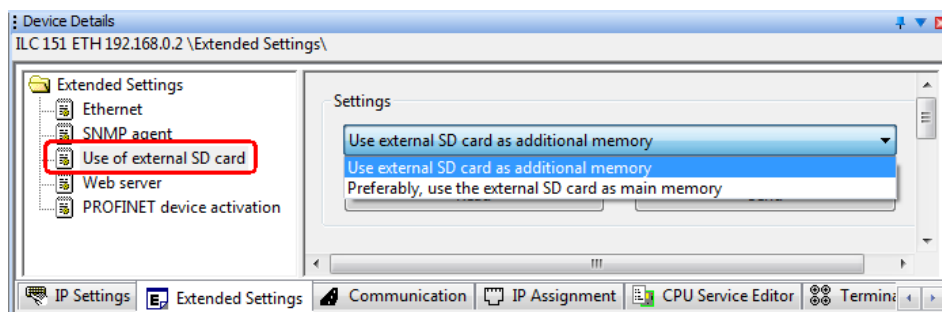

Figure 3-20 Setting the external SD card as additional memory

- In the “Device Details” window, select the “Use of external SD card” setting under “Extended Settings”.
- In the “Settings” area, select the “Use the external SD card as additional memory” setting in the drop-down list.
- Click “Send” (hidden by the drop-down list in Figure 3-20), to send the setting to the Inline controller.

In order for the settings to take effect on the Inline controller, it must be restarted.

3.7.2.1 SD card as memory for log files

The SD card can be used as memory for log files.

On the SD card, the contents of the “cfroot” directory are displayed in the “sddisk” directory. You can view the directories on the SD card by accessing the Inline controller via FTP (see Section “Parameterization memory and Internet Explorer” on page 62).

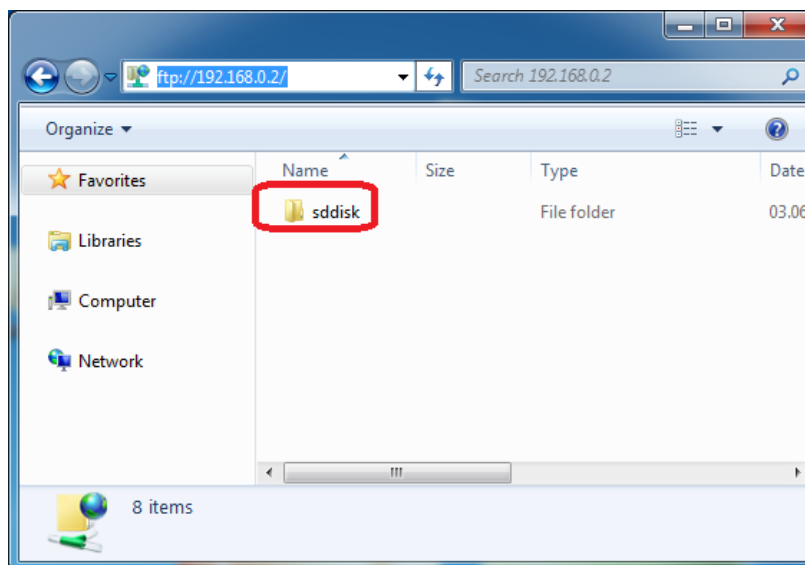

Figure 3-21 “sddisk” directory on the SD card

It is useful to create a new directory in the “sddisk” directory, in which the log files can be stored:

ILC 1X1

- Access the Inline controller via FTP.
- Open the “sddisk” directory by double clicking.
- In the “sddisk” directory, open the context menu by right clicking, and select “New, Folder”.
- Enter a name for the directory you are creating (in the example in Figure 3-22 “Logfile”).

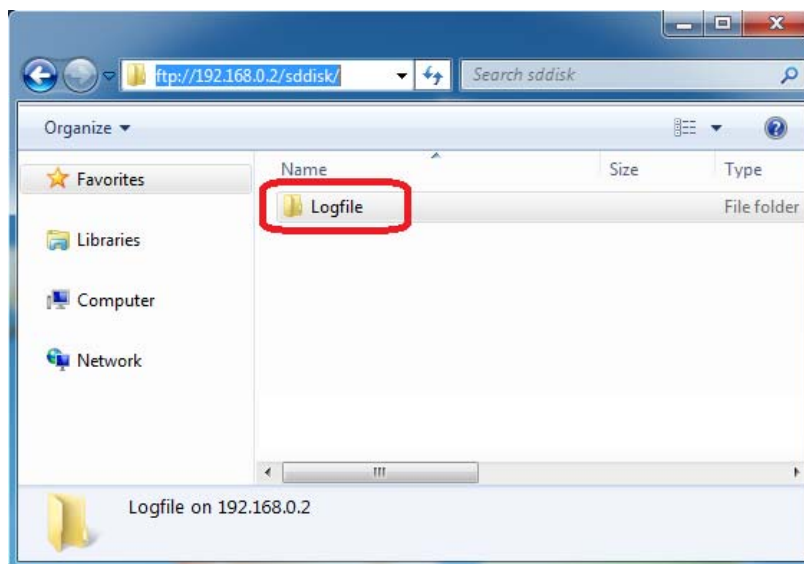

Figure 3-22 Newly created “Logfile” directory in the “sddisk” directory

To access the directories on the SD card, use the FILE function blocks in PC Worx (refer to Section 3.13 and online help on PC Worx).

If you program your application program accordingly, the log data is saved in the “Logfile.txt” file and stored in the “Logfile” directory. You can then access the file with the FILE_OPEN function block.

Figure 3-23 shows a FILE_OPEN function block for opening the “Logfile.txt” file in the “\sddisk\Logfile” directory.

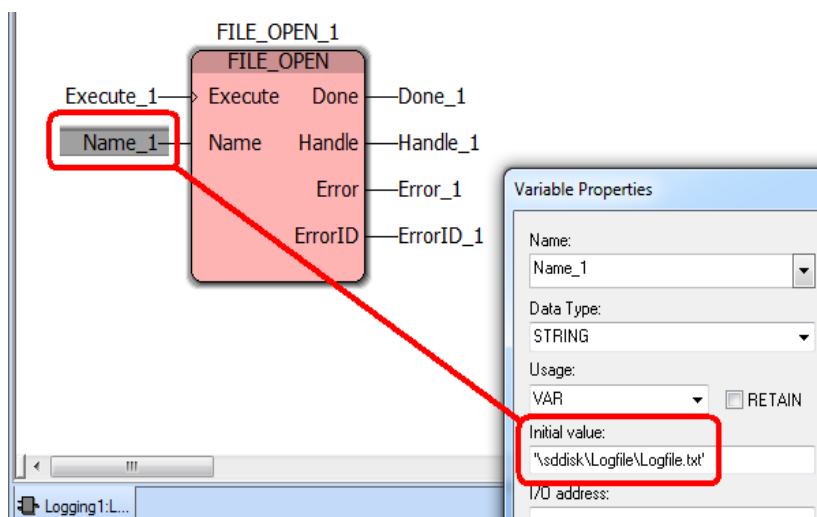

Figure 3-23 Opening the “Logfile.txt” file via the FILE_OPEN function block

The Inline controller under PC Worx/PC Worx Express

- In the “Variable Properties” dialog, (seen on the right in Figure 3-23) always enter the full path and file name.

3.8 Parameterization memory and Internet Explorer

To delete files or store user-specific files on the internal parameterization memory, proceed as follows:



The FTP functionality must be activated in Internet Explorer. See Section “Internet Explorer FTP functionality” on page 63.

- Switch to the bus configuration workspace in PC Worx.
- Select the controller, e.g., “ILC 151 ETH”, in the “Bus Structure” window.
- Select the “Extended Settings” tab in the “Device Details” window.
- Open Internet Explorer from this window by clicking on the “Open FTP Folder on Device” button.

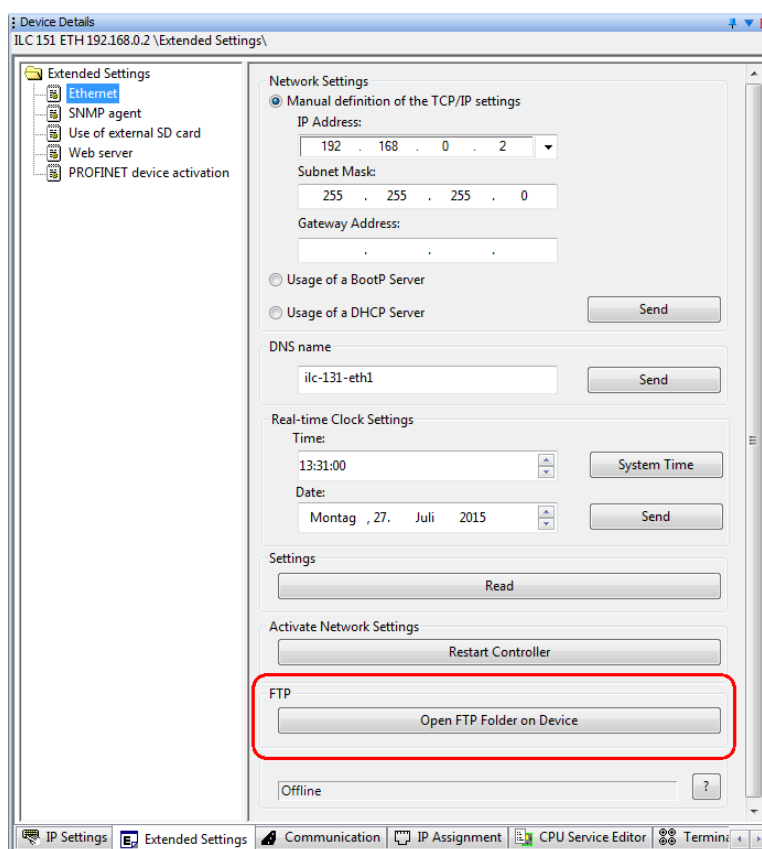

Figure 3-24 Extended Settings: Open FTP Folder on Device

The file structure, which is stored on the parameterization memory, is displayed in the Internet Explorer window.



Data may only be copied or deleted on the parameterization memory. Do not edit any files as Internet Explorer does not store modified data.

For the current state to be displayed, refresh the display after every action by means of the “View, Refresh” command.

3.8.1 Internet Explorer FTP functionality

- Activate this setting in Internet Explorer under “Tools, Internet Options, Advanced”.

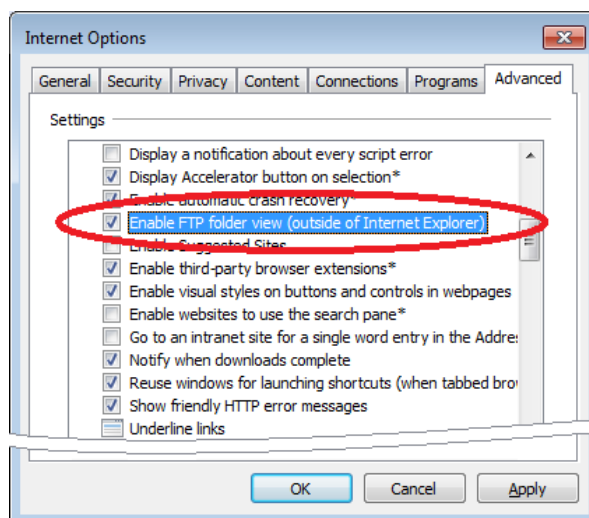

Figure 3-25 Internet Options: Enable FTP folder view

3.8.2 Activating/deactivating the FTP server

To protect the Inline controller against unauthorized access, it may be necessary to deactivate the FTP server. The CPU_Set_Value_Request service with Var ID 0172_{hex} is used for this. This service can be used to activate or deactivate the FTP server. The FTP server is deactivated immediately, once the corresponding service has been executed. If you activate the FTP server, the setting is only applied once the controller has been re-started. The set FTP server state is stored retentively and mapped to the ETH_SRV_FTP_ACTIVE system variable.

Value range for the CPU_Set_Value_Request service:

| | | |
|-----------|---------------------|-----------------------|
| Var Count | 1 | |
| Var ID | 0172 _{hex} | |
| Value | 0000 _{hex} | Deactivate FTP server |
| | 0001 _{hex} | Activate FTP server |

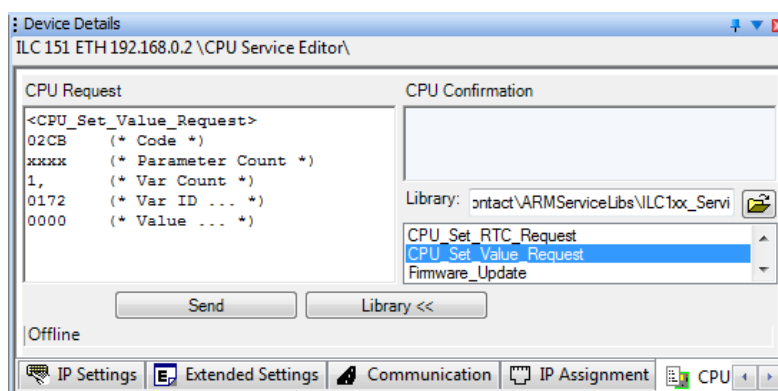

Figure 3-26 Deactivating the FTP server

3.8.3 Access restriction for FTP access



The function is available for Inline controllers with firmware versions ≥ 4.40 as of AUTOMATIONWORX Software Suite Version 1.82 AddOn V1.

To prevent unauthorized FTP access to the parameterization memory, you can specify a username (max. 12 characters) and a password (max. 12 characters). By default upon delivery, the Inline controller is set to the username “anonymous” and no password (“”) is set. This setting is also restored if you return the Inline controller to the default state upon delivery.

The CPU_Set_Value_Request service with Var ID 019A_{hex} is used to specify the username and password.

Specifying the username and password

To specify a username and password, proceed as follows:

- Switch to the bus configuration workspace in PC Worx.
- Select the controller, e.g., “ILC 151 ETH”, in the “Bus Structure” window.
- Select the “CPU Service Editor” tab in the “Device Details” window.
- Open the “ILC1xx_Service_Common.slb” library.
- Double-click to select the CPU_Set_Value_Request service.

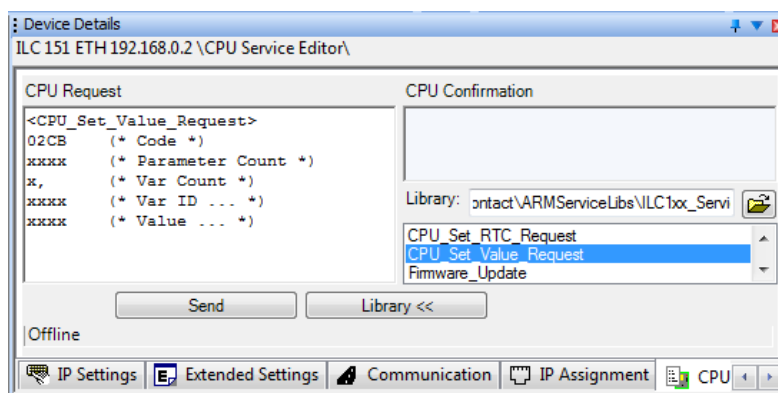

Figure 3-27 Open the library and select the service

- In the “CPU Request” area for (* Var Count *) enter the value “1”.
- In the “CPU Request” area for (* Var ID ... *) enter the value “019A”.
- In the “CPU Request” area for (* Value ... *) (changed to (* length username & username *) and (* length password & password *) in Figure 3-28) enter the desired username and password.

In doing so, the length of the username must be entered followed by the individual characters of the username in hexadecimal ASCII format. Following this, the length of the password must also be entered followed by the individual characters of the password in hexadecimal ASCII format.

ILC 1X1

Example (refer to Figure 3-28): username “USER” (length “04”), password “PASS” (length “04”)

| Charac- ter | ASCII | Charac- ter | ASCII |
|----------------|-------|----------------|-------|
| U | 55 | P | 50 |
| S | 53 | A | 41 |
| E | 45 | S | 53 |
| R | 52 | S | 53 |

For the example, for the username USER, the ASCII characters “0455 5345 52” must be entered (length of the username followed by the individual characters of the username) and subsequently, for the password PASS, the ASCII characters “04 5041 5353” must be entered (length of the password followed by the individual characters of the password).

Figure 3-28 shows the settings for defining the username “USER” and the password “PASS” in the “CPU Request” area.

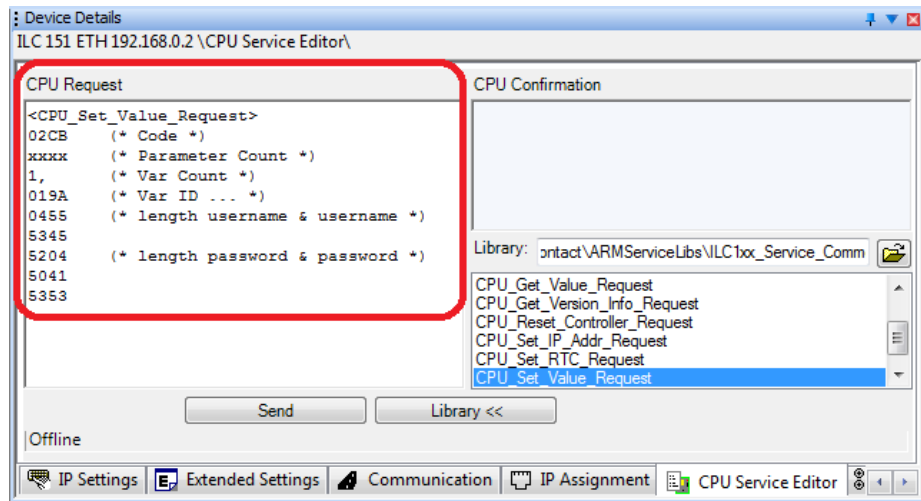

Figure 3-28 Specifying username and password for FTP access

- Click “Send” to send the settings to the Inline controller.

The new username and password are set.

Successful execution of the service is acknowledged as follows in the “CPU Confirmation” area:

```
<Cnf: CPU_Set_Value_Request>
82CB (*W1 : Confirmation_Code*)
0001 (*W2 : Parameter_Count*)
0000 (*W3 : Result*)
```

- Carry out a voltage reset on the Inline controller.

The Inline controller under PC Worx/PC Worx Express

If the parameterization memory is accessed via FTP, a dialog now appears in which the username and password must be entered.

The content of the parameterization memory is only displayed if the username and password are entered correctly.



Recommended:

If you wish to access the parameterization memory by means of a web browser, turn the cache off in the web browser.

Otherwise, in some circumstances, the contents of the parameterization memory may be displayed despite active access protection, as the data from the previous access attempt without access protection is still stored in the web browser cache.

Removing a username and password

To remove a username and password, proceed as described above, however in the “CPU Request” area, for (* Value ... *) enter the value “0000”, refer to Figure 3-29.

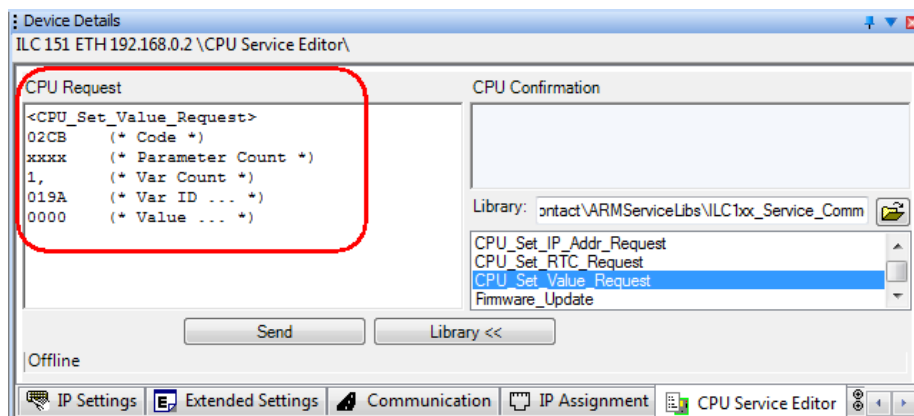

Figure 3-29 Removing the username and password for FTP access

3.8.4 Activating/deactivating the HTTP server



This function is supported by Inline controllers from firmware version 4.20 or later and from PC Worx version 6.30.767 or later (part of the AUTOMATIONWORX Software Suite 1.81 including AddOn V1).

Deactivating

To protect the Inline controller against unauthorized access, it may be necessary to deactivate the HTTP server. To do this, proceed as follows:

- Switch to the bus configuration workspace in PC Worx.
- Select the controller, e.g., “ILC 151 ETH”, in the “Bus Structure” window.
- Select the “Extended Settings” tab in the “Device Details” window.
- Select the “Web server” setting under “Extended Settings”.
- Select the setting “Disabled” from the drop-down list.
- Click “Send” (hidden by the drop-down list in Figure 3-30) to transmit the setting to the Inline controller.
- Restart the Inline controller.

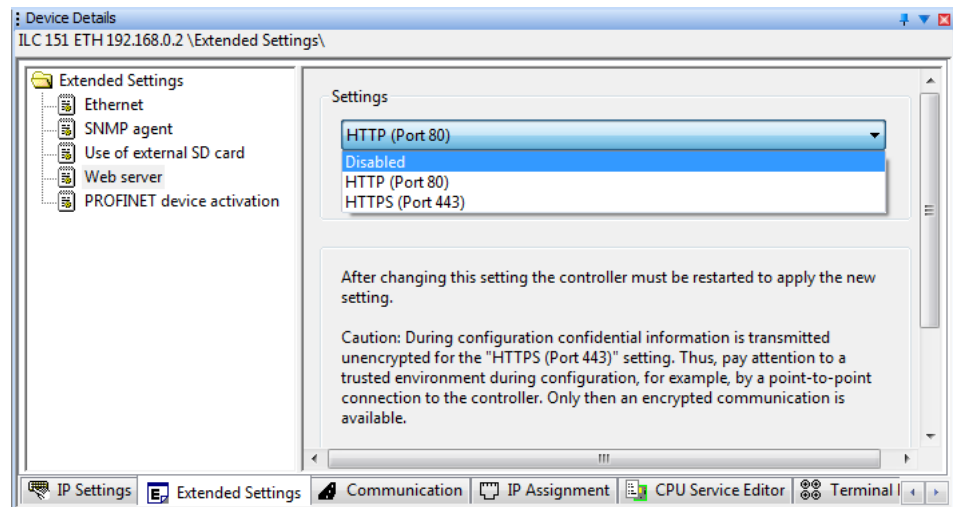

Figure 3-30 Disabling HTTP



If you have selected the “Disabled” function, the HTTP server (web server) is deactivated. HTTPS is also deactivated (refer to Section 3.8.5).

Activating

Proceed as follows to activate the HTTP server:

- Select the setting “HTTP (Port 80)” from the drop-down list.
- Click “Send” (hidden by the drop-down list in Figure 3-30) to transmit the setting to the Inline controller.
- Restart the Inline controller.

3.8.5 Using the Hypertext Transfer Protocol Secure (HTTPS)



The Inline controllers support the Hypertext Transfer Protocol Secure (HTTPS) from firmware version 4.20 or later and from PC Worx version 6.30.767 or later (part of the AUTOMATIONWORX Software Suite 1.81 including AddOn V1).

Hypertext Transfer Protocol Secure (HTTPS) can be used for the HTTP server communication.

The settings for using HTTPS are made via the “Device Details” window.

- Switch to the bus configuration workspace in PC Worx.
- Select the controller, e.g., “ILC 151 ETH”, in the “Bus Structure” window.
- Select the “Extended Settings” tab in the “Device Details” window.
- Select the “Web server” setting under “Extended Settings”.
- Select the setting “HTTPS (Port 443)” from the drop-down list.
- Click “Send” (hidden by the drop-down list in Figure 3-31) to transmit the setting to the Inline controller.
- Restart the Inline controller.

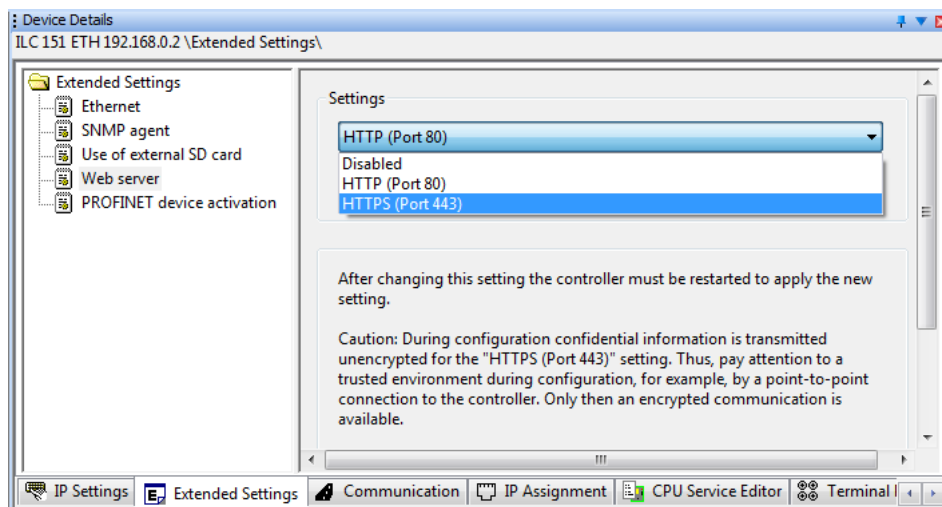

Figure 3-31 Setting HTTPS

3.9 Sending secure e-mails

You can use the SMTPS method (e-mail transmission via SMTP with SSL/TLS) to send e-mails securely. In order to use the SMTPS method, you need to import the IT library (≥ version 1_34) function block library. It can be downloaded via the product at phoenixcontact.net/products.

For more detailed information on the function block library, please refer to the online help for PC Worx.



Security certificates from the mail server are always accepted by the Inline controller and not checked.

3.10 Enabling/disabling specific ports



The function is available for Inline controllers with firmware versions ≥ 4.40 as of AUTOMATIONWORX Software Suite Version 1.82 AddOn V1.

Depending on your application, it may be necessary to disable certain ports. The CPU_Set_Value_Request service is used for this, with various Var IDs for the individual ports. This service can be used to enable or disable a port. The port is disabled immediately, once the corresponding service has been executed.

If you enable a port, the setting is only applied once the controller has been restarted.

Port 7

Value range for the CPU_Set_Value_Request service at port 7 (port for echo server):

| | | |
|-----------|---------------------|----------------|
| Var Count | 1 | |
| Var ID | 0214 _{hex} | |
| Value | 0000 _{hex} | Disable port 7 |
| | 0001 _{hex} | Enable port 7 |



If you disable port 7, the Inline controller will not be found by the AX OPC Server.

Port 1962

Value range for the CPU_Set_Value_Request service at port 1962 (port for communication with PC Worx):

| | | |
|-----------|---------------------|-------------------|
| Var Count | 1 | |
| Var ID | 0213 _{hex} | |
| Value | 0000 _{hex} | Disable port 1962 |
| | 0001 _{hex} | Enable port 1962 |

Port 41100

Value range for the CPU_Set_Value_Request service at port 41100 (port for OPC and debug mode in PC Worx):

| | | |
|-----------|---------------------|--------------------|
| Var Count | 1 | |
| Var ID | 0192 _{hex} | |
| Value | 0000 _{hex} | Disable port 41100 |
| | 0001 _{hex} | Enable port 41100 |



NOTE: Access to the Inline controller not possible

If you disable port 1962 and/or port 41100, you can no longer access the Inline controller from PC Worx.

- Only disable port 1962 and/or port 41100, if you no longer need to access the Inline controller from PC Worx.

Once you have disabled port 1962 and/or port 41100, these can only be re-enabled by resetting the Inline controller to factory defaults.

3.11 Activating/deactivating the journaling function

The file system of the Inline controller supports the journaling function. As a result, voltage failures during write processes do not destroy the file system. However, the access speed becomes slower.



The journaling function is deactivated by default.

It can be activated or deactivated via the CPU_Set_Value_Request service with Var ID 0194_{hex}.

Value range for the CPU_Set_Value_Request service:

| | | |
|-----------|---------------------|--------------------------------|
| Code | 02CB _{hex} | |
| Var Count | 0001 _{hex} | |
| Var ID | 0194 _{hex} | |
| Value | 0001 _{hex} | Activate journaling function |
| | 0000 _{hex} | Deactivate journaling function |

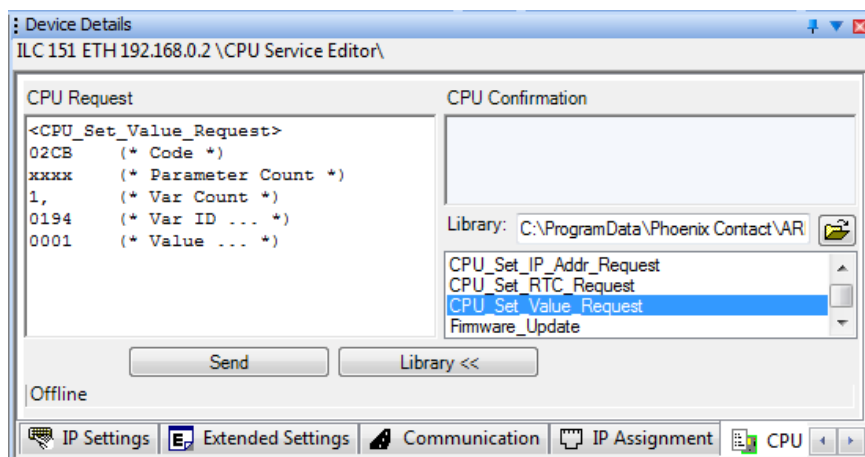

Figure 3-32 Activating the journaling function

3.12 Activating/deactivating the MRP client function

The Media Redundancy Protocol MRP can be used via the Ethernet interfaces of the ILC 171 ETH 2TX and ILC 191 ETH 2TX Inline controllers. The controllers support the MRP client function, which can be enabled or disabled via PC Worx as an option. This function is disabled by default. If the function is enabled, it remains enabled after the supply voltage is switched off and on. If the controllers have been reset to the delivery state, the MRP client function will also be disabled again. In a ring with Media Redundancy Protocol, maximum switch-over times of up to 200 ms can be expected.

To activate/deactivate the MRP client function, proceed as follows:

- Switch to the bus configuration workspace.
- Select the controller node (in the example: "ILC 171 ETH 2TX 192.168.0.2").
- Select the "Extended Settings" tab in the "Device Details" window.
- In the "Device Details" window, select the "MRP Client" setting under "Extended Settings".
- Under "Settings", select "activated" to activate the MRP client function.
or
- Under "Settings", select "deactivated" to deactivate the MRP client function.
- Click "Send".

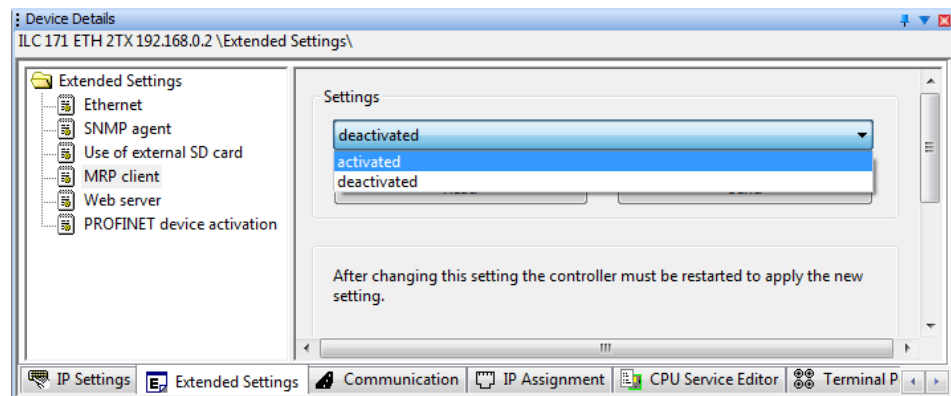

Figure 3-33 Activating the MRP client function

3.13 Function blocks for handling files on the parameterization memory

The function blocks are used to access files from within the application program. Some of the blocks support multiple instantiation. This means that it is possible to work with a number of different files within the same project. The blocks perform the standard functions that are required for typical file access operations.

The FILE_NOTIFY block is available in addition to the blocks for typical file access operations. This block can be used to detect files that have been modified in a directory containing user files. These modifications may include:

- Deletion of one or more files
- Writing one or more new files
- Modification of one or more existing files

Both modifications made to this directory via FTP (remote) and modifications made locally via function blocks or firmware services can be detected.



All file operations are subject to the following restrictions:
No directory hierarchies are supported. All file operations only affect the root directory of the parameterization memory.

The functional blocks are valid for:

| Order designation | As of hardware version | As of firmware version |
|-------------------|------------------------|------------------------|
| ILC 131 ETH | 00 | 4.00 |
| ILC 151 ETH | 00 | 4.00 |
| ILC 171 ETH 2TX | 00 | 4.00 |
| ILC 191 ETH 2TX | 00 | 4.00 |
| ILC 131 ETH/XC | 00 | 4.00 |
| ILC 151 ETH/XC | 00 | 4.00 |

Table 3-3 Overview of the function blocks

| Function block | Short description |
|----------------|---|
| FILE_OPEN | Opens a file with a specific name |
| FILE_CLOSE | Closes a file with a specific handle |
| FILE_READ | Reads from a file with a specific handle |
| FILE_WRITE | Writes to a file with a specific handle |
| FILE_REMOVE | Deletes a file with a specific name |
| FILE_TELL | Determines the current position of the file pointer in a file |
| FILE_SEEK | Moves the current file pointer to a new position |
| FILE_NOTIFY | Displays files that have recently been created, deleted or modified |



The function blocks for handling files on the parameterization memory are described in the PC Worx online help.

3.14 Function blocks for Ethernet communication

The function blocks are used to establish Ethernet communication between two communication partners.

The IP communication blocks listed below enable IEC 61131-5-compliant communication between controllers via Ethernet or communication between controllers and Ethernet devices via TCP/IP or UDP/IP.

Implement all time and connection monitoring in the application program.

The function blocks are valid for the Inline controllers listed in the table below in the specified hardware/firmware versions and enable the specified maximum number of TCP/IP or UDP/IP communication connections:

| Order designation | Blocks | As of hardware version (HW) | As of firmware version (FW) | Ethernet connections to other communication partners (maximum) |
|-------------------|-------------|-----------------------------|-----------------------------|--|
| ILC 131 ETH | IEC 61131-5 | 00 | 4.00 | 8 |
| | TCP/IP | | | |
| | UDP/IP | | | |
| ILC 151 ETH | IEC 61131-5 | 00 | 4.00 | 8 |
| | TCP/IP | | | |
| | UDP/IP | | | |
| ILC 171 ETH 2TX | IEC 61131-5 | 00 | 4.00 | 8 |
| | TCP/IP | | | 16 |
| | UDP/IP | | | |
| ILC 191 ETH 2TX | IEC 61131-5 | 00 | 4.00 | 8 |
| | TCP/IP | | | 16 |
| | UDP/IP | | | |
| ILC 131 ETH/XC | IEC 61131-5 | 00 | 4.00 | 8 |
| | TCP/IP | | | |
| | UDP/IP | | | |
| ILC 151 ETH/XC | IEC 61131-5 | 00 | 4.00 | 8 |
| | TCP/IP | | | |
| | UDP/IP | | | |

Table 3-4 Overview of the function blocks

| Function block | Short description |
|----------------|---|
| IP_CONNECT | Establishes a connection between two communication partners |
| IP_USEND | Sends data to a communication partner |
| IP_URCV | Receives data from a communication partner |



The communication blocks are described in the PC Worx online help. The extensions for the TCP/IP and UDP/IP function blocks are described in the "TCP/UDP COMMUNICATION" application note.

3.15 Function blocks for PCP communication

The function blocks are used to establish PCP communication between the Inline controller and PCP devices in INTERBUS.

The function blocks are valid for the Inline controllers listed in the table below in the specified hardware/firmware versions and enable the specified maximum number of PCP communication connections:

| Order designation | As of hardware version (HW) | As of firmware version (FW) | Connections to PCP devices (maximum) |
|-------------------|-----------------------------|-----------------------------|--------------------------------------|
| ILC 131 ETH | 00 | 4.00 | 8 |
| ILC 151 ETH | 00 | 4.00 | 16 |
| ILC 171 ETH 2TX | 00 | 4.00 | 24 |
| ILC 191 ETH 2TX | 00 | 4.00 | 24 |
| ILC 131 ETH/XC | 00 | 4.00 | 8 |
| ILC 151 ETH/XC | 00 | 4.00 | 16 |

Table 3-5 Overview of the function blocks

| Function block | Short description |
|----------------|--|
| PCP_CONNECT | This block can be used to set up communication connections to each PCP device in INTERBUS. |
| PCP_WRITE | This block enables PCP objects to be written. |
| PCP_READ | This block enables data to be read from PCP objects. |
| PCP_SERVER | This block enables PCP service indications to be received and responses to be sent. |



The communication blocks are described in the PC Worx online help.

3.16 Alignment

The alignment of the data elements in the Inline controller memory can result in “data gaps” when storing data in the memory. The compiler automatically fills these gaps with padding bytes during the compilation process in order to prevent incorrect processing.

The disadvantage of the “automatic” filling of data gaps becomes apparent when data is transmitted from the Inline controller to another controller. If this controller does not know the memory algorithm of the Inline controller, it will interpret the received data incorrectly.

It is therefore useful to program the filling of data gaps in your application program. Alternatively, you can use the PACK and UNPACK function blocks (see online help in PC Worx). Data transmissions to other controllers can therefore be taken into consideration. For example, use byte arrays with an even number of bytes and/or word arrays in order to avoid data gaps in your application program.

Please observe the following notes for program creation:

- Create data types in flat structures, i.e., do not nest user-defined data types.
- Insert padding bytes manually in order to ensure the uniform size and layout of the data types.
- When inserting padding bytes, observe the memory alignment method of the controllers used in the application (1-byte, 2-byte, or 4-byte alignment).

Program example with data gaps

The following program example shows how data gaps are filled.

```

1  TYPE
2      Struct1 :
3      STRUCT
4          ByteElement : BYTE;
5          WordElement : WORD;
6      END_STRUCT;
7
8      Struct2 :
9      STRUCT
10         WordElement : WORD;
11         ByteElement : BYTE;
12     END_STRUCT;
13
14     Struct3 :
15     STRUCT
16         ByteElement1 : BYTE;
17         ByteElement2 : BYTE;
18     END_STRUCT;
19
20     Struct4 :
21     STRUCT
22         Struct2Element : Struct2;
23         Struct3Element : Struct3;
24     END_STRUCT;
25
26     Array1 : ARRAY [0..1] OF Struct2;
27 END_TYPE

```

Figure 3-34 Example programming

The Inline controller under PC Worx/PC Worx Express

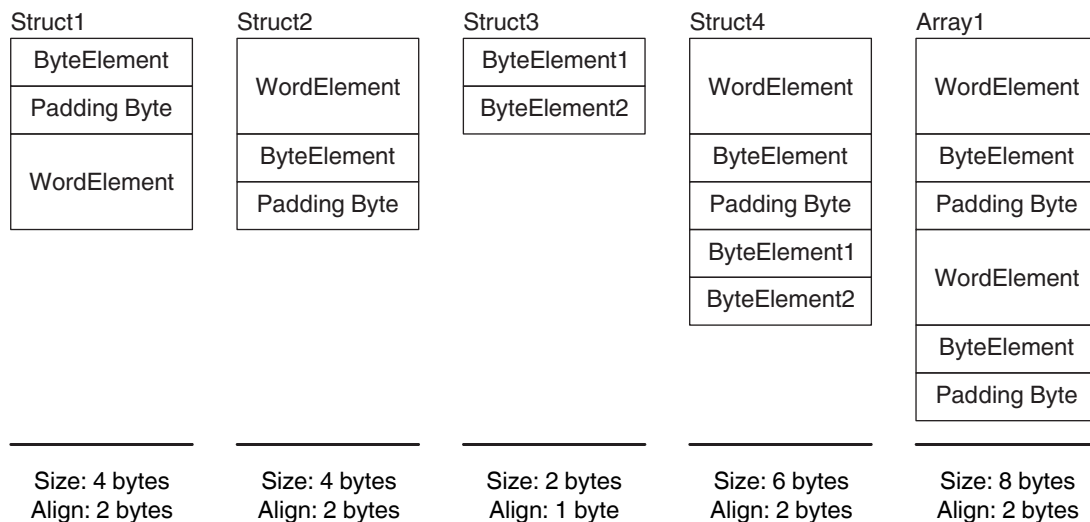

Figure 3-35 Alignment - padding bytes in data gaps

Struct1 receives a padding byte after the ByteElement so that the WordElement is at a WORD address (address that can be divided by 2 leaving no remainder). The alignment of the overall structure is based on the data type used with maximum alignment. In this case, the WordElement specifies the alignment.

The size of Struct2 is calculated based on the elements used and the resulting alignment. The corresponding number of padding bytes is inserted so that the size of the data type with the value of the alignment can be divided by 2 leaving no remainder (data type size modulo alignment = 0).

Struct3 does not receive any padding bytes as the maximum alignment corresponds to one byte.

Due to the padding byte that belongs to the Struct2 structure, the Struct3 structure starts at an even address in Struct4.

Array1 receives 2 padding bytes corresponding to two consecutive Struct2 structures.

ILC 1X1

Program example without data gaps

The following program shows an example of how to fill data gaps in your application program. Fill data gaps, which are to be expected due to the memory alignment, with application data (padding bytes in Figure 3-36).

```

1  TYPE
2  Struct1 :
3  STRUCT
4      ByteElement : BYTE;
5      ByteElement : BYTE; (*Padding-Byte*)
6      WordElement : WORD;
7  END_STRUCT;
8
9  Struct2 :
10 STRUCT
11     WordElement : WORD;
12     ByteElement : BYTE;
13     ByteElement : BYTE; (*Padding-Byte*)
14 END_STRUCT;
15
16 Struct3 :
17 STRUCT
18     ByteElement1 : BYTE;
19     ByteElement2 : BYTE;
20 END_STRUCT;
21
22 STRUCT4 :
23 STRUCT
24     Struct2Element : Struct2;
25     Struct3Element : Struct3;
26 END_STRUCT;
27
28 Array1 : ARRAY [0..1] OF Struct2;
29 END_TYPE

```

Figure 3-36 Example programming with padding bytes

4 System variables and status information

4.1 General notes

This section describes the special program functions of the PC Worx/PC Worx Express software that are available for the Inline controller.



The following descriptions of system variables and status information apply to PC Worx and PC Worx Express.

The Inline controller has a register set, which is used for diagnostics and easy control of the bus system. The diagnostic data is stored in the diagnostic status register and the diagnostic parameter register. These registers are available to the application program as system variables (system flags, global variables).

Operating states, error states, and additional information about the INTERBUS system can be evaluated in the application program.



For additional information on diagnostics, please refer to the following user manual:

- INTERBUS diagnostics guide
IBS SYS DIAG DSC UM E

Order No. 2747293

4.2 Status register for local digital inputs and outputs

The following system variables can be used to read the local digital input and output states and to write the local digital output states.

Table 4-1 System variables of the status register for local digital inputs and outputs

| System variable | Type | Meaning |
|-----------------------------|------|---|
| ONBOARD_INPUT | WORD | State of all local inputs |
| ONBOARD_INPUT_BIT0 | BOOL | State of local input IN1 |
| ONBOARD_INPUT_BIT1 | BOOL | State of local input IN2 |
| ONBOARD_INPUT_BIT2 | BOOL | State of local input IN3 |
| ONBOARD_INPUT_BIT3 | BOOL | State of local input IN4 |
| ONBOARD_INPUT_BIT4 | BOOL | State of local input IN5 |
| ONBOARD_INPUT_BIT5 | BOOL | State of local input IN6 |
| ONBOARD_INPUT_BIT6 | BOOL | State of local input IN7 |
| ONBOARD_INPUT_BIT7 | BOOL | State of local input IN8 |
| ONBOARD_OUTPUT_BIT0 | BOOL | State of local output OUT1 |
| ONBOARD_OUTPUT_BIT1 | BOOL | State of local output OUT2 |
| ONBOARD_OUTPUT_BIT2 | BOOL | State of local output OUT3 |
| ONBOARD_OUTPUT_BIT3 | BOOL | State of local output OUT4 |
| ONBOARD_OUTPUT_OVERLOAD_0_3 | BOOL | Overload at at least one of the local outputs |

4.3 Diagnostic status register

Information on the operating state of the Inline controller is stored in the diagnostic status register. Every bit in the diagnostic status register is assigned a certain Inline controller state.

The following system variables can be used to read the diagnostic status register information.

Table 4-2 System variables of the diagnostic status register

| System variable | Type | Meaning |
|--------------------------------|------|--|
| MASTER_DIAG_STATUS_REG_USER | BOOL | User error/parameterization error |
| MASTER_DIAG_STATUS_REG_PF | BOOL | I/O error |
| MASTER_DIAG_STATUS_REG_BUS | BOOL | Bus error |
| MASTER_DIAG_STATUS_REG_CTRL | BOOL | Error on Inline controller/hardware fault |
| MASTER_DIAG_STATUS_REG_DTC | BOOL | Diagnostic routine is active |
| MASTER_DIAG_STATUS_REG_RUN | BOOL | Data transmission is active |
| MASTER_DIAG_STATUS_REG_ACT | BOOL | Selected configuration is ready to operate |
| MASTER_DIAG_STATUS_REG_RDY | BOOL | Inline controller is ready to operate |
| MASTER_DIAG_STATUS_REG_BSA | BOOL | Bus segment aborted |
| MASTER_DIAG_STATUS_REG_SYSFAIL | BOOL | System failure |
| MASTER_DIAG_STATUS_REG_RES | BOOL | Standard function processed negatively |
| MASTER_DIAG_STATUS_REG_SYNCRES | BOOL | Synchronization error occurred |
| MASTER_DIAG_STATUS_REG_DCR | BOOL | Faulty data cycles |
| MASTER_DIAG_STATUS_REG_WARN | BOOL | Defined warning time exceeded |
| MASTER_DIAG_STATUS_REG_QUAL | BOOL | Defined error density exceeded |
| MASTER_DIAG_STATUS_REG_SSINFO | BOOL | A message is present |
| MASTER_DIAG_STATUS_REG_HI | BYTE | Master diagnostic status register, high byte |
| MASTER_DIAG_STATUS_REG_LOW | BYTE | Master diagnostic status register, low byte |

4.4 Diagnostic parameter register

The diagnostic parameter register provides additional information on the error indicated in the diagnostic status register. The following information is stored in the diagnostic parameter register:

- Error location
- Error code

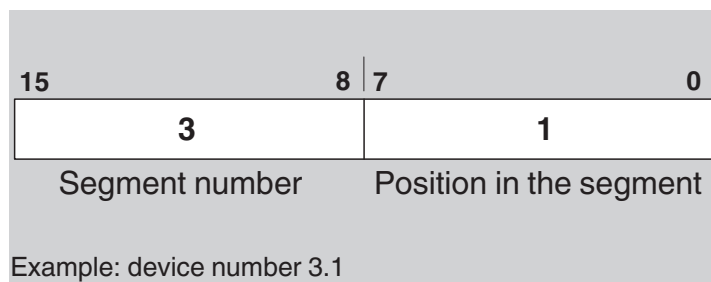

Figure 4-1 Error location in the diagnostic parameter register



Special case: if an interface error cannot be located, the value 128 is indicated in the diagnostic parameter register, i.e., bit 7 is set.

The diagnostic parameter register is rewritten whenever an error occurs. The diagnostic parameter register contains the value “0” if no errors are detected.

Table 4-3 System variables of the diagnostic parameter register

| System variable | Type | Meaning |
|-----------------------------|------|---|
| MASTER_DIAG_PARAM_REG_HI | BYTE | Diagnostic parameter register, high byte |
| MASTER_DIAG_PARAM_REG_LOW | BYTE | Diagnostic parameter register, low byte |
| MASTER_DIAG_PARAM_2_REG_HI | BYTE | Extended diagnostic parameter register, high byte |
| MASTER_DIAG_PARAM_2_REG_LOW | BYTE | Extended diagnostic parameter register, low byte |

4.5 PROFINET register



The PC Worx Express software does not support this function.

Table 4-4 PROFINET system variables (PROFINET device function)

| System variable | Type | Meaning |
|---------------------------|------------|--|
| PND_S1_PLC_RUN | BOOL | Status of the higher-level controller/PROFINET controller Information indicating whether the higher-level controller is active. The value is TRUE if the higher-level controller is in the RUN state (program). The display only applies when there is an existing PROFINET connection (PND_S1_VALID_DATA_CYCLE). |
| PND_S1_VALID_DATA_CYCLE | BOOL | The higher-level controller/higher-level PROFINET controller has established the connection. Information indicating whether a connection exists and cyclic data is being exchanged between the PROFINET controller and PROFINET device and whether the last frame received contained valid data. |
| PND_S1_OUTPUT_STATUS_GOOD | BOOL | IOP status of the higher-level controller/higher-level PROFINET controller Information indicating whether the IN process data of the PROFINET device (PND_S1_INPUTS) was received by the PROFINET device with "valid" status. The value is TRUE if the output data of the higher-level controller is valid (provider status). |
| PND_S1_DATA_LENGTH | WORD | Process data length that was configured for the PROFINET device. |
| PND_S1_OUTPUTS | PND_IO_256 | OUT process data Memory area for OUT process data that the PROFINET device sends to the higher-level controller/higher-level PROFINET controller. |
| PND_S1_INPUTS | PND_IO_256 | IN process data Memory area for IN process data that the PROFINET device receives from the higher-level controller/higher-level PROFINET controller. |
| PND_IO_DRIVEN_BY_PLC | INT | Applicative system redundancy Specifies from which higher-level PROFINET controller the data in the PROFINET device originates (refer to Figure 2-5 on page 16) 0: No PROFINET controller 1: Controller A 2: Controller B |

4.6 IEC 61131 runtime system

There is a separate group of system variables for the IEC 61131 runtime system.

Table 4-5 System variables of the IEC 61131 runtime system

| System variable | Type | Meaning |
|-----------------------|-----------------------|--|
| PLCMODE_ON | BOOL | PLC status ON: the runtime system on the Inline controller is ready to operate. |
| PLCMODE_RUN | BOOL | PLC status RUN: the application program is running. |
| PLCMODE_STOP | BOOL | PLC status STOP: the application program is currently not running. |
| PLCMODE_HALT | BOOL | PLC status HALT: the application program was stopped at an unspecified point. |
| PLCDEBUG_BPSET | BOOL | Breakpoint set: at least one breakpoint has been set in the application program. |
| PLCDEBUG_FORCE | BOOL | Variable(s) forced: at least one variable is being continuously overwritten (forced). |
| PLCDEBUG_POWERFLOW | BOOL | Powerflow ON: in "Powerflow" mode, you can see which parts of your application program are being processed. This bit indicates whether "Powerflow" mode is active. |
| PLC_TICKS_PER_SEC | INT | System ticks per second: this variable shows how many pulses the system clock of the Inline controller delivers per second. |
| PLC_SYS_TICK_CNT | DINT | Number of system ticks: this variable shows the total number of pulses delivered by the system clock since the last startup. |
| PLC_TASK_AVAILABLE | INT | Number of available PLC tasks |
| PLC_SYSTASK_AVAILABLE | INT | Number of available system tasks |
| PLC_MAX_ERRORS | DINT | Maximum number of "errors, warnings, and logging events". If this maximum number is reached, the controller is stopped. |
| PLC_ERRORS | DINT | Number of "errors, warnings, and logging events" currently entered. |
| PLC_TASK_DEFINED | INT | Number of tasks used |
| PLC_TASK_1 | Record, elements = 17 | Information regarding task 1 |
| : | : | : |
| PLC_TASK_8 | Record, elements = 9 | Information regarding task 8 |

4.7 Control processor

The system variables listed below show the states of the diagnostic status register on the control processor of the Inline controller.

Table 4-6 System variables of the control processor

| System variable | Type | Meaning |
|-----------------------------|------|---|
| COP_DIAG_STATUS_REG_RT_ERR | BOOL | A runtime error (out of realtime) has occurred on the control processor. |
| COP_DIAG_STATUS_REG_FAT_ERR | BOOL | A fatal error has occurred on the control processor. Division by zero, for example, leads to a fatal error. |
| COP_DIAG_STATUS_REG_WARN | BOOL | A warning has been issued on the control processor. |
| COP_DIAG_STATUS_REG_PON | BOOL | Power ON (COP): the control processor is ready to operate. |
| COP_DIAG_STATUS_REG_FC_RUN | BOOL | Runtime system RUN |
| COP_DIAG_STATUS_REG_FC_STOP | BOOL | Runtime system STOP |
| COP_DIAG_STATUS_REG_FC_HALT | BOOL | Runtime system HALT |
| COP_DIAG_STATUS_REG_FC_LDG | BOOL | Runtime system LOADING |
| COP_DIAG_STATUS_REG_FC_DBG | BOOL | Runtime system DEBUG |
| COP_DIAG_STATUS_REG_FC_RDO | BOOL | Runtime system READONLY |
| COP_DIAG_PARAM_REG | WORD | Diagnostic parameter register of the control processor |
| COP_DIAG_PARAM_2_REG | WORD | Extended diagnostic parameter register of the control processor |

4.8 Power storage, realtime clock



The realtime clock of the ILC 131 ETH/XC and ILC 151 ETH/XC Inline controllers has no power storage. When switching on the power supply, the realtime clock must be synchronized again. The SNTP function blocks from the IT library are required for synchronization. The IT library can be downloaded at phoenixcontact.net/products.

Table 4-7 System variables of the power storage and realtime clock

| System variable | Type | Meaning |
|------------------|------|--|
| RTC_BATTERY_LOW | BOOL | Low capacity of the power storage for the realtime clock. TRUE: Power storage device is being charged. FALSE: Power storage device is fully charged. The charging process is complete. |
| RTC_DATA_INVALID | BOOL | The realtime clock data is invalid. |

4.9 Power supplies

Table 4-8 System variables of the power supplies

| System variable | Type | Meaning |
|-----------------------------|------|--|
| POWER_SUPPLY_MAIN_OK | BOOL | The 24 V main power supply is OK. |
| POWER_SUPPLY_INPUTS_OK | BOOL | The 24 V power supply for the local inputs is OK. |
| POWER_SUPPLY_OUTPUTS_0_3_OK | BOOL | The 24 V power supply for the local outputs is OK. (Bits 0 to 3) |

4.10 Mode selector switch

Table 4-9 System variables of the mode selector switch

| System variable | Type | Meaning |
|---------------------|------|---|
| KEY_SWITCH_RESET | BOOL | The mode selector switch is in the MRESET position. |
| KEY_SWITCH_STOP | BOOL | The mode selector switch is in the STOP position. |
| KEY_SWITCH_RUN_PROG | BOOL | The mode selector switch is in the RUN_PROG position. |

4.11 System time

Table 4-10 System variables of the system time

| System variable | Type | Meaning |
|-----------------|------|-----------------------|
| RTC_HOURS | INT | System time (hours) |
| RTC_MINUTES | INT | System time (minutes) |
| RTC_SECONDS | INT | System time (seconds) |
| RTC_DAY | INT | System time (day) |
| RTC_MONTH | INT | System time (month) |
| RTC_YEAR | INT | System time (year) |

ILC 1X1

5 Technical data and ordering data

5.1 Technical data

| General data | |
|--|--|
| Dimensions | 80 mm x 119.8 mm x 71.5 mm |
| Weight | 285 g, approximately (ILC 131 ETH, ILC 151 ETH, ILC 131 ETH/XC, ILC 151 ETH/XC) 295 g, approximately (ILC 171 ETH 2TX, ILC 191 ETH 2TX) |
| Connection data for connectors | |
| Connection method | Spring connection |
| Conductor cross section | |
| Single-wire/terminal point, solid | 0.08 mm ² to 1.5 mm ² |
| Single-wire/terminal point, stranded | 0.08 mm ² to 1.5 mm ² |
| Single-wire/terminal point, AWG | 28 to 16 |
| We recommend using a conductor cross section of 0.2 mm ² to 1.5 mm ² . | |
| Coated PCBs | ILC 131 ETH/XC and ILC 151 ETH/XC only |

General supply



Use a **power supply without fall-back characteristic curve** (see Section "Sizing of the power supply" on page 37).

24 V main supply U_M

| | |
|--|--|
| Connection technology | Spring-cage terminal blocks |
| Nominal value | 24 V DC |
| Tolerance | -15%/+20% (according to EN 61131-2) |
| Ripple | ±5% |
| Current consumption at nominal voltage (typical) | 6 mA + 7 mA for each input set |
| Current consumption at nominal voltage (maximum) | 8 A DC |
| Continuation | Through potential routing |
| Protective measures | |
| Surge voltage | Input protective diodes (can be destroyed by permanent overload) Pulse loads up to 1500 W are short circuited by the input protective diode. |
| Polarity reversal | Parallel diodes for protection against polarity reversal; in the event of an error the high current flowing through the diodes causes the fuse connected upstream to blow. |



NOTE:

Provide external protection for the 24 V area. The power supply unit must be able to supply 4 times (400%) the nominal current of the external fuse, to ensure that the fuse blows safely in the event of an error.

ILC 1X1**24 V segment supply U_S**

| | |
|--|--|
| Connection technology | Spring-cage terminal blocks |
| Nominal value | 24 V DC |
| Tolerance | -15%/+20% (according to EN 61131-2) |
| Ripple | ±5% |
| Current consumption at nominal voltage (typical) | 10 mA + 10 mA for each output set + load |
| Current consumption at nominal voltage (maximum) | 8 A |
| Continuation | Through potential routing |
| Protective measures | |
| Surge voltage | Input protective diodes (can be destroyed by permanent overload) Pulse loads up to 1500 W are short circuited by the input protective diode. |
| Polarity reversal | Parallel diodes for protection against polarity reversal; in the event of an error the high current flowing through the diodes causes the fuse connected upstream to blow. |

**NOTE:**

Provide external protection for the 24 V area. The power supply unit must be able to supply 4 times (400%) the nominal current of the external fuse, to ensure that the fuse blows safely in the event of an error.

24 V supply U_{ILC}

| | |
|--|---|
| Connection technology | Spring-cage terminal blocks |
| Nominal value | 24 V DC |
| Tolerance | -15%/+20% (according to EN 61131-2) |
| Ripple | ±5% |
| Permissible range | 19.2 to 30 V DC |
| Current consumption at nominal voltage (minimum) | 80 mA (no-load operation, i.e., no local bus devices connected, bus inactive) |
| Current consumption at nominal voltage (typical) | 210 mA |
| Current consumption at nominal voltage (maximum) | 870 mA (370 mA communications power + 500 mA analog power supply) |
| Protective measures | |
| Surge voltage | Input protective diodes (can be destroyed by permanent overload) Pulse loads up to 1500 W are short circuited by the input protective diode. |
| Polarity reversal | Serial diode in the lead path of the power supply unit; in the event of an error only a low current flows. In the event of an error, no fuse trips within the external power supply unit. |

**NOTE:****Observe the current consumption of the Inline terminals**

Observe the logic current consumption of each device when configuring an Inline station. It is specified in every terminal-specific data sheet. The current consumption can differ depending on the individual terminal. The permissible number of devices that can be connected therefore depends on the specific station structure.

Protection by the external power supply unit

Ensure protection of 2 A through the external power supply unit.

Technical data and ordering data

7.5 V communications power U_L (potential jumper)

| | |
|------------------------|---|
| Nominal value | 7.5 V DC |
| Tolerance | ±5% |
| Ripple | ±1.5 % |
| Maximum output current | 0.8 A DC, observe derating (internally protected against short circuit) |
| Derating | See Section "Derating" on page 99. |

24 V analog supply U_{ANA} (potential jumper)

| | |
|------------------------|--|
| Nominal value | 24 V DC |
| Tolerance | -15 %/+20% |
| Ripple | ±5% |
| Maximum output current | 0.5 A DC, observe derating (see Section "Derating" on page 99) |
| Protective measures | Electric short-circuit protection |

PROFINET

| | |
|-------------------|---|
| Type | PROFINET device |
| Specification | 2.2 |
| Performance class | RT |
| Update rate | ≥ 1 ms |
| Number of slots | 1 |
| Vendor ID | |
| ILC 131 ETH | 00B0 _{hex} /176 _{dec} |
| ILC 151 ETH | 00B0 _{hex} /176 _{dec} |
| ILC 171 ETH 2TX | 00B0 _{hex} /176 _{dec} |
| ILC 191 ETH 2TX | 00B0 _{hex} /176 _{dec} |
| ILC 131 ETH/XC | 00B0 _{hex} /176 _{dec} |
| ILC 151 ETH/XC | 00B0 _{hex} /176 _{dec} |
| Device ID | |
| ILC 131 ETH | 007D _{hex} /125 _{dec} |
| ILC 151 ETH | 007E _{hex} /126 _{dec} |
| ILC 171 ETH 2TX | 007A _{hex} /122 _{dec} |
| ILC 191 ETH 2TX | 007B _{hex} /123 _{dec} |
| ILC 131 ETH/XC | 007D _{hex} /125 _{dec} |
| ILC 151 ETH/XC | 007E _{hex} /126 _{dec} |

INTERBUS

| | |
|----------------------|--------------------|
| Number of I/O points | 4096, maximum |
| Number of data words | 256, maximum |
| Transmission speed | 500 kbps or 2 Mbps |



This speed is automatically set according to the connected Inline terminals. Only use terminals with a uniform transmission speed in the overall connected Inline system (local bus and remote bus).

| | |
|--------------------------|--------------------------------|
| Transmission reliability | CR check (Hamming distance: 4) |
| Protocol | EN 50254 |

ILC 1X1**Number of devices in the INTERBUS system**

Total number of bus devices

| | |
|---|--------------|
| ILC 131 ETH, ILC 131 ETH/XC | 63, maximum |
| ILC 151 ETH, ILC 151 ETH/XC, ILC 171 ETH 2TX, ILC 191 ETH 2TX | 128, maximum |

Number of remote bus devices

| | |
|---|-------------|
| ILC 131 ETH, ILC 131 ETH/XC | – |
| ILC 151 ETH, ILC 151 ETH/XC, ILC 171 ETH 2TX, ILC 191 ETH 2TX | 32, maximum |

Number of devices with parameter channel (PCP)

| | |
|-----------------------------|-------------------|
| ILC 131 ETH, ILC 131 ETH/XC | See Section 3.15. |
| ILC 151 ETH, ILC 151 ETH/XC | 8 |
| ILC 171 ETH 2TX | 16 |
| ILC 191 ETH 2TX | 24 |
| ILC 191 ETH 2TX | 24 |

Number of remote bus levels

| | |
|---|------------------|
| ILC 131 ETH, ILC 131 ETH/XC | See Section 2.2. |
| ILC 151 ETH, ILC 151 ETH/XC, ILC 171 ETH 2TX, ILC 191 ETH 2TX | – |
| | 4, maximum |



Please note: the ILC 131 ETH and ILC 131 ETH/XC controllers do not support connection of the INTERBUS remote bus.

Network interface

Type

| | |
|--|---|
| ILC 131 ETH, ILC 151 ETH, ILC 131 ETH/XC, ILC 151 ETH/XC | 1 x Ethernet; 10Base-T and 100Base-T(X) |
| ILC 171 ETH 2TX, ILC 191 ETH 2TX | 2 x Ethernet; 10Base-T and 100Base-T(X) |

Transmission speed

10 Mbps (10Base-T), 100 Mbps (100Base-T(X))
half duplex, full duplex, auto negotiation



This speed cannot be set manually. It is set automatically by means of auto negotiation.

Connection technology

CAT5 twisted pair cable
Twisted pair cable with a conductor cross section of 0.14 mm² to 0.22 mm²
8-pos. RJ45 socket

Inline local bus

Interface Inline local bus

Electrical isolation No

Number of devices

| | |
|---|--------------|
| ILC 131 ETH, ILC 131 ETH/XC | 63, maximum |
| ILC 151 ETH, ILC 151 ETH/XC, ILC 171 ETH 2TX, ILC 191 ETH 2TX | 128, maximum |

**NOTE: Observe the current consumption of the Inline terminals**

Observe the logic current consumption of each device when configuring an Inline station. It is specified in every terminal-specific data sheet. The current consumption can differ depending on the individual terminal. The permissible number of devices that can be connected therefore depends on the specific station structure.

Modbus/TCP

Number of I/O points

8192, maximum (internal Modbus/TCP client) (only ILC 131 ETH(XC))
16384, maximum (internal Modbus/TCP client) (only ILC 151 ETH(XC))
32768, maximum (internal Modbus/TCP client) (only ILC 171 ETH 2TX)
32768, maximum (internal Modbus/TCP client) (only ILC 191 ETH 2TX)

Technical data and ordering data

INTERBUS

| | |
|----------------------|--------------------|
| Number of I/O points | 4096, maximum |
| Number of data words | 256, maximum |
| Transmission speed | 500 kbps or 2 Mbps |



This speed is automatically set according to the connected Inline terminals. Only use terminals with a uniform transmission speed in the overall connected Inline system (local bus and remote bus).

| | |
|--------------------------|--------------------------------|
| Transmission reliability | CR check (Hamming distance: 4) |
| Protocol | EN 50254 |

Diagnostic interface

| | |
|-----------------------|-------------------------------|
| Connection technology | 6-pos. MINI-DIN socket (PS/2) |
| Interface type | RS-232 |
| Transmission speed | 9600 baud |
| Electrical isolation | No |

Digital inputs

| | |
|--|---|
| Quantity | 8 |
| Input design | According to EN 61131-2 type 1 |
| Definition of the switching thresholds | |
| Maximum low-level voltage | 5 V DC |
| Minimum high-level voltage | 15 V DC |
| Nominal input voltage | 24 V DC |
| Permissible range | -0.5 V < U_{IN} < +30 V DC |
| Nominal input current at 24 V | 7 mA, typical; 15 mA, maximum |
| Hardware filter times, typical | |
| Inputs I1 to I8 | |
| Signal change 0 -> 1 | 5 ms |
| Signal change 1 -> 0 | 5 ms |
| Permissible cable length to the sensor | 30 m (to ensure conformance with EMC Directive 2004/108/EC) |
| Use of AC sensors | AC sensors in the voltage range < U_{IN} are limited in application (according to the input design) |

Digital outputs

| | |
|---|---|
| Quantity | 4 |
| Output design | Protected outputs according to EN 61131-2 |
| Nominal output voltage | 24 V DC |
| Nominal output current | 500 mA |
| Nominal current I_{nom} per channel | 0.5 A |
| Total current | 2 A |
| Nominal load | |
| Ohmic | 12 W |
| Lamp | 12 W |
| Inductive | 12 VA (1.2 H) |
| Switching frequency with nominal inductive load | 0.5 Hz (1.2 H), maximum |
| Behavior in the event of nominal inductive load | Output may be damaged |

ILC 1X1

Diagnostics and status indicators

| | |
|---|-----------------------|
| IEC 61131 runtime system (PLC) | FR, FF |
| Ethernet (ETH) | LINK, ACT |
| INTERBUS diagnostics (IL) | RDY, BSA, FAIL, PF |
| Digital inputs and outputs | I1 to I8, E, Q1 to Q4 |
| Supply voltages | US, UM, UL |
| PROFINET (ILC 171 ETH 2TX, ILC 191 ETH 2TX) | BF, SF |

| IEC 61131 runtime system | ILC 131 ETH, ILC 131 ETH/XC | ILC 151 ETH, ILC 151 ETH/XC | ILC 171 ETH 2TX | ILC 191 ETH 2TX |
|---------------------------------------|--|--|--|--|
| Programming system | PC Worx | PC Worx | PC Worx | PC Worx |
| Processing speed | | | | |
| 1 K mixed instructions | 1.7 ms | 1.5 ms | 1.5 ms | 1.3 ms |
| 1 K bit instructions | 90 µs | 90 µs | 90 µs | 90 µs |
| Shortest cycle time (for cyclic task) | 1 ms | 1 ms | 1 ms | 1 ms |
| Program memory | 192 kbytes, 16 K instructions (IL) | 256 kbytes, 21 K instructions (IL) | 512 kbytes, 43 K instructions (IL) | 1 Mbyte, 86 K instructions (IL) |
| Mass storage | 192 kbytes | 256 kbytes | 512 kbytes | 1 Mbyte |
| Retentive mass storage | 8 kbytes, NVRAM | 8 kbytes, NVRAM | 48 kbytes, NVRAM | 48 kbytes, NVRAM |
| Number of data blocks | Depends on mass stor- age | Depends on mass stor- age | Depends on mass stor- age | Depends on mass stor- age |
| Number of control tasks | 8 | 8 | 8 | 8 |
| Parameterization memory | | | | |
| Integrated | 4 Mbytes Flash mem- ory (100,000 write ac- cess operations per sector, typical) | 4 Mbytes Flash mem- ory (100,000 write ac- cess operations per sector, typical) | 4 Mbytes Flash memory (100,000 write access operations per sector, typical) | 4 Mbytes Flash memory (100,000 write access operations per sector, typical) |
| Plug-in, SD card | 256 Mbytes/2 Gbytes (1,000,000 write ac- cess operations per sector, typical), see Section "Accessories" on page 95 | 256 Mbytes/2 Gbytes (1,000,000 write ac- cess operations per sector, typical), see Section "Accessories" on page 95 | 256 Mbytes/2 Gbytes (1,000,000 write access operations per sector, typical), see Section "Accessories" on page 95 | 256 Mbytes/2 Gbytes (1,000,000 write access operations per sector, typical), see Section "Accessories" on page 95 |



Please note that the number of write access operations to the parameterization memory is limited.

We recommend that you limit the number of write access operations to the parameterization memory in your application program by first storing data on the data memory and/or the memory for retentive data (NVRAM). Write access operations to the parameterization memory for small volumes of data (bits, bytes) should not be possible in your application program. Data should only be transferred from the mass storage/memory for retentive data to the parameterization memory if the mass storage/memory for retentive data is full, i.e., data must be deleted first to enable further write access operations.

Realtime clock

| | |
|-----------------------------|----------------------|
| Accuracy | 1 min./week, maximum |
| Power reserve | 10 days |
| Power storage charging time | 24 hr. |

Technical data and ordering data

| Ambient conditions | ILC 131 ETH, ILC 151 ETH, ILC 171 ETH 2TX, ILC 191 ETH 2TX | ILC 131 ETH/XC, ILC 151 ETH/XC |
|---|--|---|
| Degree of protection | IP20 (EN 60529:1991) | IP20 (EN 60529:1991) |
| Ambient temperature (operation) | -25°C to +55°C | -40°C to +55°C (see also Appendix A 5 "Tested successfully: use under extreme ambient conditions") |
| Ambient temperature (operation) | | -40°C to +60°C (with US < 24.5 V, see also Appendix A 5 "Tested successfully: use under extreme ambient conditions") For derating information, see Appendix A 4.2 "ILC 131 ETH/XC and ILC 151 ETH/XC derating" |
| Permissible temperature (storage/transport) | -25°C to +85°C | -40°C to +85°C |
| Temperature class | T4 | T2, -40°C to +55°C, IEC 50155 |
|  This temperature range is only guaranteed if the Inline controller is mounted horizontally. | | |
| Permissible humidity (operation/storage/transport) | 10% to 95%, according to DIN EN 61131-2 No condensation, no ice formation | 10% to 95%, according to DIN EN 61131-2 No condensation, no ice formation |
| Permissible air pressure (operation/storage/transport) | 70 kPa to 106 kPa (up to 3000 m above sea level) | |
| Gases that may endanger functions according to DIN 40046-36, DIN 40046-37 | | |
| Sulfur dioxide (SO ₂) | Concentration 10 ±0.3 ppm Ambient conditions - Temperature: 25°C (±2°C) - Humidity: 75% (±5%) - Test duration: 10 days | |
| Hydrogen sulfide (H ₂ S) | Concentration 1 ±0.3 ppm Ambient conditions - Temperature: 25°C (±2°C) - Humidity: 75% (±5%) - Test duration: 4 days | |
| Resistance of housing material to termites | Resistant | |
| Resistance of housing material to fungal decay | Resistant | |

Mechanical tests

| | |
|---|---------------|
| Vibration resistance according to EN 60068-2-6, IEC 60068-2-6 | Operation: 5g |
| Shock test according to EN 60068-2-27, IEC 60068-2-27 | 25g |

Conformance with EMC Directive 2004/108/EC

Noise immunity test according to EN 61000-6-2

| | | |
|-------------------------------|--------------------------------|--|
| Electrostatic discharge (ESD) | EN 61000-4-2/ IEC 61000-4-2 | Criterion B 6 kV contact discharge 8 kV air discharge |
| Electromagnetic fields | EN 61000-4-3 IEC 61000-4-3 | Criterion A Field strength: 10 V/m |
| Fast transients (burst) | EN 61000-4-4/ IEC 61000-4-4 | Criterion B Supply lines: 2 kV Signal/data lines: 2 kV |
| Surge test | EN 61000-4-5 IEC 61000-4-5 | Criterion B Signal/data lines: 1 kV Supply lines: 0.5 kV |

ILC 1X1

Conformance with EMC Directive 2004/108/EC

Conducted disturbance variables

EN 61000-4-6
IEC 61000-4-6Criterion A
Test voltage: 10 V**Noise emission test according to EN 61000-6-4**

Noise emission of housing

EN 55011

Class A

ApprovalsFor the latest approvals, please visit phoenixcontact.com or phoenixcontact.net/products.

5.2 Ordering data

5.2.1 Modules

| Description | Type | Order No. | Pcs./Pkt. |
|---|-----------------|-----------|-----------|
| Inline controller, including accessories (connectors and labeling fields) | ILC 131 ETH | 2700973 | 1 |
| Inline controller, including accessories (connectors and labeling fields) | ILC 151 ETH | 2700974 | 1 |
| Inline controller, including accessories (connectors and labeling fields) | ILC 171 ETH 2TX | 2700975 | 1 |
| Inline controller, including accessories (connectors and labeling fields) | ILC 191 ETH 2TX | 2700976 | 1 |
| Inline controller, including accessories (connectors and labeling fields) | ILC 131 ETH/XC | 2701034 | 1 |
| Inline controller, including accessories (connectors and labeling fields) | ILC 151 ETH/XC | 2701141 | 1 |

5.2.2 Accessories

| Description | Type | Order No. | Pcs./Pkt. |
|--|---|-----------|-----------|
| Inline connector set for Inline bus coupler with connected I/Os | IL BKDIO-PLSET | 2878599 | 1 |
| Connecting cable for connecting the Inline controller to a PC (RS-232) cable | COM CAB MINI DIN | 2400127 | 1 |
| Program and configuration memory, plug-in, 512 Mbytes | SD FLASH 512MB | 2988146 | 1 |
| Program and configuration memory, plug-in, 512 Mbytes, with license key for function block libraries, e.g., for: SNMP, SQL, wireless, motion functions, etc. | SD FLASH 512MB APPLIC A | 2701799 | 1 |
| Program and configuration memory, plug-in, 2 Gbytes | SD FLASH 2GB | 2988162 | 1 |
| Program and configuration memory, plug-in, 2 Gbytes with license key for function block libraries, e.g., for: SNMP, SQL, wireless, motion functions, etc. | SD FLASH 2GB APPLIC A | 2701190 | 1 |
| QUINT POWER power supplies | See current catalog from Phoenix Contact phoenixcontact.net/products | | |

5.2.3 Software

| Description | Type | Order No. | Pcs./Pkt. |
|-------------------------------------|---|-----------|-----------|
| PC Worx Express automation software | PC WORX EXPRESS | 2988670 | 1 |
| PC Worx automation software | See current catalog from Phoenix Contact phoenixcontact.net/products | | |

5.2.4 Documentation

| Description | Type | Order No. | Pcs./Pkt. |
|--|--------------------------|-----------|-----------|
| "Modbus TCP with Phoenix Contact controllers" application note | AH EN MODBUS/TCP | - | 1 |
| "Configuring and installing the INTERBUS Inline product range" user manual | IB IL SYS PRO UM E | - | 1 |
| "Automation terminals of the Inline product range" user manual | IL SYS INST UM E | - | 1 |
| "PC Worx Express Version 5.20 or later" quick start guide | UM QS EN PC WORX EXPRESS | - | 1 |
| "PC Worx Version 6.10 or later" quick start guide | UM QS EN PC WORX | - | 1 |

ILC 1X1

| Description | Type | Order No. | Pcs./Pkt. |
|--|-------------------------------------|------------------|------------------|
| "PROFINET basics" user manual | UM EN PROFINET SYS | - | 1 |
| "PROFINET controller/device functions" user manual | UM EN PROFINET CTRL DEV | - | 1 |
| "Applicative system redundancy" application note | AH EN APPLICATIVE SYSTEM REDUNDANCY | - | 1 |

A Appendix: service, maintenance, derating, and ambient conditions

A 1 Error causes and remedies

Table A-1 Installation error causes and remedies

| Error | Cause | Remedy |
|---|---|---|
| No outputs can be set. | The power supply U_S is not present (see diagnostics LED). | Connect the power supply. |
| The devices connected to the Inline controller cannot be read in. | The power supply U_S is not present (see diagnostics LED). | Connect the power supply. |
| The IEC 61131 program is not running. | Mode selector switch in STOP position. | Set mode selector switch to RUN/PROG position. |
| The serial interface is not operating. | The connector pin assignment of the connecting cable or of the connector adapter used is incorrect. | Use the COM CAB MINI DIN connecting cable for the Inline controller, with Order No. 2400127. |
| The devices on the remote bus cannot be started up. | The IBS IL 24 RB-T-PAC Inline terminal is not installed directly after the Inline controller. | Insert the terminal as the first Inline terminal directly next to the Inline controller. |
| The diagnostics LED of a device is flashing quickly. | The device has not been assembled correctly. | Check the connection to the previous module (bus contacts). |
| The Inline controller cannot be addressed via the IP address. | The IP address on the Inline controller has been changed or does not match the IP settings of the network devices involved. | Check the IP settings and adapt them to your application, if necessary (see also Section "Assigning the IP address for the controller" on page 45). |

A 2 Updating the Inline controller firmware

The firmware (integrated software on the Inline controller) can be updated using the Ethernet interface. Such firmware updates are exclusively used for adding new functions that are implemented within the scope of continuous product improvement. No firmware update is required for normal system operation.



To update the firmware, please proceed as described in the "Firmware update ILC 1.../3..., RFC 4..." application note. It can be downloaded at phoenixcontact.net/products.

A 3 Connecting unshielded cables

Unshielded cables are used to connect the I/O devices and the supply voltage to the Inline controller.

Connect these cables to the relevant Inline connectors using the spring-cage connection method. You may connect cables with a connection cross section of 0.2 mm² to 1.5 mm² (24 - 16 AWG).

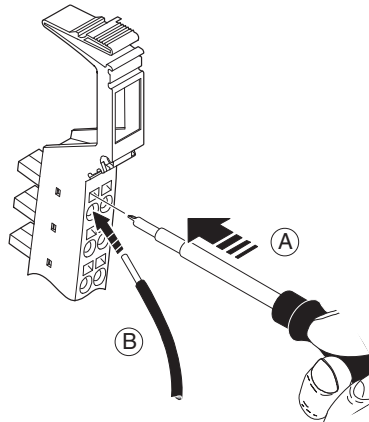

Figure A-1 Connecting unshielded cables

Wire the connectors according to your application.

When wiring, proceed as follows:

- Strip 8 mm off the cable.



Inline wiring is normally carried out without ferrules. However, it is possible to use ferrules. If using ferrules, make sure they are properly crimped.

- Push a screwdriver into the actuation shaft of the appropriate terminal point (Figure A-1, A) so that you can insert the wire into the spring opening. Phoenix Contact recommends the SFZ 1-0,6x3,5 screwdriver (Order No. 1204517).
- Insert the wire (Figure A-1, B). Remove the screwdriver from the opening. This clamps the wire.

After installation, the wires and the terminal points should be marked.

A 4 Derating

A 4.1 ILC 131 ETH, ILC 151 ETH, ILC 171 ETH 2TX, and ILC 191 ETH 2TX derating

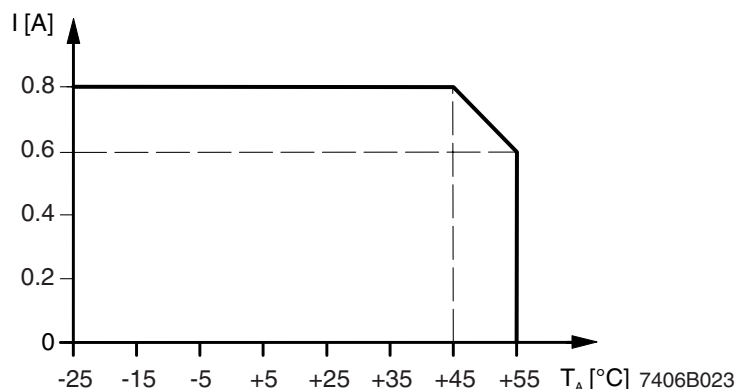

Figure A-2 ILC 131 ETH, ILC 151 ETH, ILC 171 ETH 2TX, and ILC 191 ETH 2TX derating

Key:

I [A] Logic current in A
 T_A [°C] Ambient temperature in °C

A 4.2 ILC 131 ETH/XC and ILC 151 ETH/XC derating

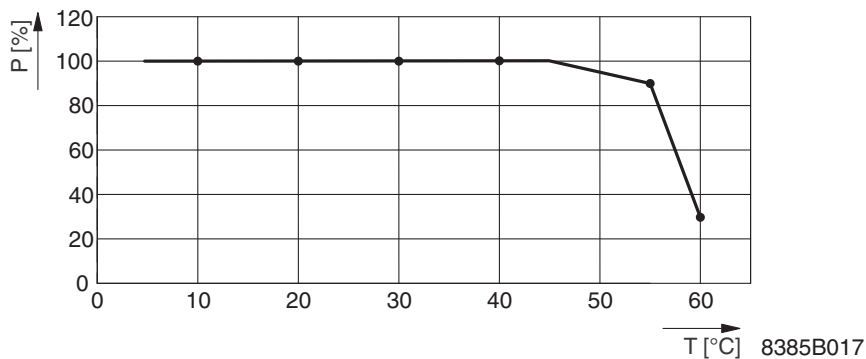

Figure A-3 ILC 131 ETH/XC and ILC 151 ETH/XC derating

Key:

P [%] Power dissipation as a percentage
 T [°C] Ambient temperature in °C

The specifications refer to a supply voltage of 24 V.

ILC 1X1

When working with a voltage from the upper voltage range (e.g., 30 V), the percentage values increase. In this case, multiply the percentage values by 1.25 ($30\text{ V}/24\text{ V} = 1.25$).

The various functions of the Inline controller have different percentage shares of the power dissipation.

For the percentage shares, please refer to the following table:

| Function | Percentage shares of power dissipation as a % |
|-----------------|--|
| Inputs | 24 |
| Outputs | 13 |
| U_M | 27 |
| U_{ANA} | 4 |
| U_L | 32 |

Tested successfully: use under extreme ambient conditions

A 5 Tested successfully: use under extreme ambient conditions

The Inline controllers (ILC 131 ETH/XC, ILC 151 ETH/XC) have been tested successfully over 250 temperature change cycles according to IEC 61131-2 in the range from -40°C to $+70^{\circ}\text{C}$.

The following conditions were observed:

- The Inline devices for all connecting cables were connected with a minimum conductor cross section of 0.5 mm^2 .
- The Inline controller was installed on a wall-mounted horizontal DIN rail.
- Fans were used to ensure continuous movement of air in the control cabinet.
- The Inline controller was not exposed to vibration or shock.
- The Inline controller was operated with a maximum of 24.5 V (ensured by using electronically regulated power supply units).

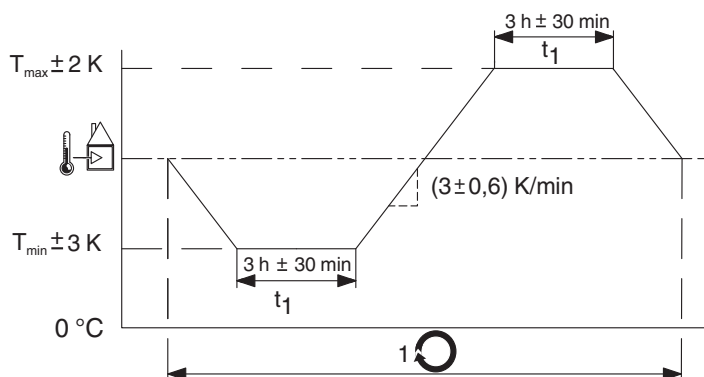

Figure A-4 Temperature change cycle



Temperature in the control cabinet/ambient temperature



Cycle



WARNING:

The Inline controllers (ILC 131 ETH/XC, ILC 151 ETH/XC) are not approved for use in safety technology.

ILC 1X1

B Appendix for document lists

B 1 List of figures

Section 2

| | | |
|--------------|--|----|
| Figure 2-1: | Connected Inline local bus | 13 |
| Figure 2-2: | Connected Inline local bus | 13 |
| Figure 2-3: | Remote bus levels | 14 |
| Figure 2-4: | PROFINET device using the ILC 171 ETH 2TX as an example | 15 |
| Figure 2-5: | Applicative system redundancy – example | 16 |
| Figure 2-6: | Structure of the Inline controller (ILC 131 ETH, ILC 151 ETH, ILC 131 ETH/XC, ILC 151 ETH/XC; shown in the figure: ILC 151 ETH) | 19 |
| Figure 2-7: | Structure of the Inline controller (ILC 171 ETH 2TX, ILC 191 ETH 2TX; shown in the figure: ILC 171 ETH 2TX) | 20 |
| Figure 2-8: | Diagnostics and status indicators | 21 |
| Figure 2-9: | Mode selector switch | 24 |
| Figure 2-10: | Inserting (A) and removing (B) the parameterization memory | 26 |
| Figure 2-11: | Internal basic circuit diagram (ILC 171 ETH 2TX) | 27 |
| Figure 2-12: | Snapping on the Inline controller (1) | 29 |
| Figure 2-13: | Snapping on the Inline controller (2) | 29 |
| Figure 2-14: | Connectors to be removed if terminals are installed next to the Inline controller | 30 |
| Figure 2-15: | Removing the Inline controller (1) | 31 |
| Figure 2-16: | Removing the Inline controller (2) | 31 |
| Figure 2-17: | Communication paths: (A1/A2) Ethernet (B) PRG | 32 |
| Figure 2-18: | Ethernet interface | 33 |
| Figure 2-19: | Connecting the Ethernet cable to the Inline controller A1: ILC 131 ETH, ILC 151 ETH, ILC 131 ETH/XC, ILC 151 ETH/XC A2: ILC 171 ETH 2TX, ILC 191 ETH 2TX | 33 |
| Figure 2-20: | Connecting cable between PC and Inline controller | 34 |
| Figure 2-21: | Overload range with fall-back characteristic curve | 37 |
| Figure 2-22: | Overload range without fall-back characteristic curve | 37 |
| Figure 2-23: | Supply voltage connection | 38 |
| Figure 2-24: | Assignment of terminal points of connectors 2 to 4 | 41 |
| Figure 2-25: | Basic wiring of an output with a load (L) (shown using the ILC 151 ETH as an example) | 42 |

Section 3

| | | |
|--------------|---|----|
| Figure 3-1: | Project information after creating a new project | 44 |
| Figure 3-2: | DCP: setting the IP address | 45 |
| Figure 3-3: | Starting IP address assignment via DCP | 46 |
| Figure 3-4: | Entering the MAC address | 47 |
| Figure 3-5: | “Extras, BootP/SNMP/TFTP-Configuration...” menu | 48 |
| Figure 3-6: | “Activate BootP” button | 48 |
| Figure 3-7: | Message window following BootP | 48 |
| Figure 3-8: | Switching on the PROFINET device function | 49 |
| Figure 3-9: | “Settings Communication Path” dialog | 49 |
| Figure 3-10: | PROFINET device function/settings - Send: Service executed successfully | 50 |
| Figure 3-11: | Activate Network Settings: Restart Controller | 51 |
| Figure 3-12: | “Settings Communication Path” dialog | 51 |
| Figure 3-13: | Activating the network settings: service executed successfully | 52 |
| Figure 3-14: | Bus Structure: PROFINET context menu “Read PROFINET...” | 53 |
| Figure 3-15: | “Read PROFINET” dialog | 53 |
| Figure 3-16: | ILC 131 ETH inserted as a PROFINET device | 54 |
| Figure 3-17: | ILC 131 ETH as a PROFINET device: Process Data | 54 |
| Figure 3-18: | Procedure for using the external SD card as main or additional memory | 56 |
| Figure 3-19: | Setting the SD card as main memory | 57 |
| Figure 3-20: | Setting the external SD card as additional memory | 59 |
| Figure 3-21: | “sddisk” directory on the SD card | 59 |
| Figure 3-22: | Newly created “Logfile” directory in the “sddisk” directory | 60 |
| Figure 3-23: | Opening the “Logfile.txt” file via the FILE_OPEN function block | 60 |
| Figure 3-24: | Extended Settings: Open FTP Folder on Device | 62 |
| Figure 3-25: | Internet Options: Enable FTP folder view | 63 |
| Figure 3-26: | Deactivating the FTP server | 64 |
| Figure 3-27: | Open the library and select the service | 65 |
| Figure 3-28: | Specifying username and password for FTP access | 66 |
| Figure 3-29: | Removing the username and password for FTP access | 67 |
| Figure 3-30: | Disabling HTTP | 68 |
| Figure 3-31: | Setting HTTPS | 69 |
| Figure 3-32: | Activating the journaling function | 71 |
| Figure 3-33: | Activating the MRP client function | 72 |
| Figure 3-34: | Example programming | 76 |
| Figure 3-35: | Alignment - padding bytes in data gaps | 77 |

| | | |
|--------------|--|----|
| Figure 3-36: | Example programming with padding bytes | 78 |
|--------------|--|----|

Section 4

| | | |
|-------------|---|----|
| Figure 4-1: | Error location in the diagnostic parameter register | 81 |
|-------------|---|----|

Appendix A

| | | |
|-------------|--|-----|
| Figure A-1: | Connecting unshielded cables | 98 |
| Figure A-2: | ILC 131 ETH, ILC 151 ETH, ILC 171 ETH 2TX, and ILC 191 ETH 2TX derating | 99 |
| Figure A-3: | ILC 131 ETH/XC and ILC 151 ETH/XC derating | 99 |
| Figure A-4: | Temperature change cycle | 101 |

ILC 1X1

B 2 List of tables

Section 2

| | | |
|------------|---|----|
| Table 2-1: | Inline controller operating modes | 24 |
| Table 2-2: | Function block overview | 35 |
| Table 2-3: | Terminal point assignment..... | 41 |

Section 3

| | | |
|------------|--|----|
| Table 3-1: | Software version information | 43 |
| Table 3-2: | Version information for "Download Changes" | 55 |
| Table 3-3: | Overview of the function blocks | 73 |
| Table 3-4: | Overview of the function blocks | 74 |
| Table 3-5: | Overview of the function blocks | 75 |

Section 4

| | | |
|-------------|---|----|
| Table 4-1: | System variables of the status register for local digital inputs and outputs..... | 79 |
| Table 4-2: | System variables of the diagnostic status register | 80 |
| Table 4-3: | System variables of the diagnostic parameter register..... | 81 |
| Table 4-4: | PROFINET system variables (PROFINET device function) | 82 |
| Table 4-5: | System variables of the IEC 61131 runtime system | 83 |
| Table 4-6: | System variables of the control processor | 84 |
| Table 4-7: | System variables of the power storage and realtime clock..... | 84 |
| Table 4-8: | System variables of the power supplies | 85 |
| Table 4-9: | System variables of the mode selector switch | 85 |
| Table 4-10: | System variables of the system time | 85 |

Appendix A

| | | |
|------------|--|----|
| Table A-1: | Installation error causes and remedies | 97 |
|------------|--|----|

ILC 1X1

B 3 Index

A

Applicative system redundancy 16

B

Basic wiring of an output 42

BootP 46, 47

BootP server 31

C

Communication path 32

Connecting cables 98

Connecting the supply voltage 38

Connecting unshielded cables 98

Connection elements 19

Connector 29

Control box 28

See also Terminal box

Control cabinet 28

D

Delivery state 25

Diagnostics indicators 21

Digital inputs 41

Digital outputs 41

DIN rail 28

E

Electronics base 29

End brackets 28

End plate 28

Error causes 97

Error diagnostics 21

Ethernet 33

Ethernet interface 33

F

Fall-back characteristic curve 37

Fields of application

ILC 131 ETH, ILC 131 ETH/XC 13

ILC 151 ETH, ILC 151 ETH/XC,
ILC 171 ETH 2TX, ILC 191 ETH 2TX 13

ILC 171 ETH 2TX, ILC 191 ETH 2TX 16

Firmware update 97

FTP access

Deactivate FTP server 64

Username and password 65

FTP functionality 62

H

Hardware requirements 9

HTTP server

Activating/deactivating the HTTP server 68

Using HTTPS 69

I

ILC 131 ETH, ILC 151 ETH, ILC 131 ETH/XC,
ILC 151 ETH/XC

Connectors 19

diagnostic and status indicators 19

electronics base 19

end plate 19

Ethernet connection 19

mode selector switch 19

parameterization memory, integrated 25

reset button 19

RS-232 interface 19

ILC 171 ETH 2TX, ILC 191 ETH 2TX

card holder 20

connectors 20

diagnostic and status indicators 20

electronics base 20

end plate 20

Ethernet connection 20

mode selector switch 20

reset button 20

RS-232 interface 20

slot for parameterization memory 20

Inline local bus 13

INTERBUS 36

IP20 28

L

Local bus 36

ILC 1X1**M**

| | |
|----------------------------|--------|
| MAC address | 31 |
| Mode selector switch | 24 |
| Mounting | 28, 29 |
| Mounting location | 28 |
| Mounting position | 28 |

O

| | |
|--------------------------|----|
| Operating elements | 19 |
|--------------------------|----|

P

| | |
|---|--------|
| Parameterization memory | 25 |
| Parameterization memory, integrated | 25 |
| Parameterization memory, plug-in | 25 |
| Ports | 70 |
| Power supply | 37 |
| Connection | 38 |
| Power supply sizing | 37 |
| Power supply without fall-back characteristic curve | 37, 87 |

PROFINET

| | |
|--|----|
| “Read PROFINET” dialog | 53 |
| Activating the device function | 49 |
| Device inserted | 54 |
| Device process data | 54 |
| Integrating the device (example) | 52 |
| PROFINET device | 49 |
| Read PROFINET | 53 |

R

| | |
|---------------------------------------|--------|
| Realtime clock | 55 |
| Removal | 28, 30 |
| Replacement | 31 |
| Reset button | 25 |
| resetting the Inline controller | 25 |
| Resetting the controller | 51 |
| RS-232 cable | 34 |

S**SD card**

| | |
|----------------------------|----|
| Additional memory | 58 |
| Functions | 56 |
| Main memory | 56 |
| Memory for log files | 59 |
| Serial PRG interface | 34 |

Setting the IP address

| | |
|----------------------------------|----|
| BootP | 46 |
| DCP | 45 |
| Sizing of the power supply | 37 |
| Software requirements | 9 |
| Status indicators | 21 |
| System variables | 79 |

T

| | |
|--------------------|----|
| Terminal box | 28 |
|--------------------|----|



SCATTERGOOD & JOHNSON LTD

ELECTRICAL ENGINEERING & FLUID CONTROL DISTRIBUTORS

Est.1899

At Scattergood & Johnson Ltd, we pride ourselves on being a technical distributor to specialist industries.

Working with a range of quality product suppliers across a number of specialist markets, we are not your average 'box shifter' - we are your technical and supply chain partner.

We fully support every product we sell - for free! Our internal team and external sales engineers can answer any product or application question, no matter the complexity.

Backing up this technical ability is a range of 50,000+ products available from stock for nationwide next day delivery (same day if required!), or you can collect what you need from any of our trade counters around the UK.

Select your specialist interest below to learn more about how we can help.

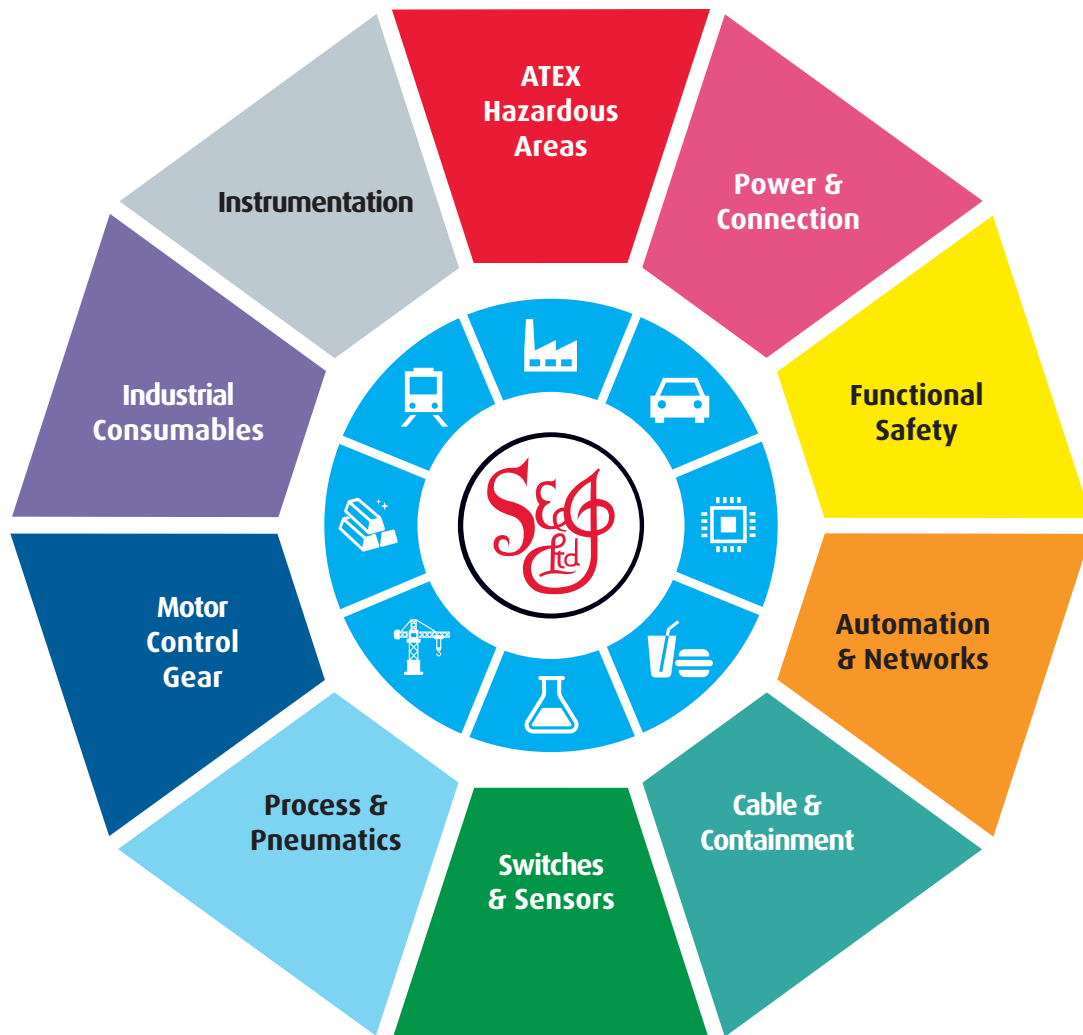

Online, In Branch and On the Road - Scattergood & Johnson Ltd, there when you need us.

www.scatts.co.uk