

IB IL UTH 4/K-ECO

**Inline ECO, Temperature measurement terminal,
analog UTH inputs: 4 (type K)**

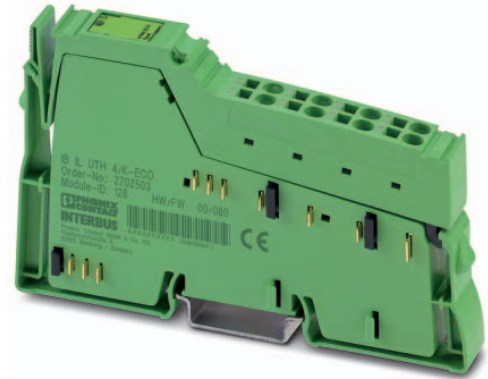

Data sheet
107152_en_01

© PHOENIX CONTACT 2016-11-15

1 Description

The terminal is designed for use within an Inline station. This terminal can be used to acquire signals from standard thermocouples.

The terminal supports type K thermocouples according to DIN EN 60584-1.

The measured values are depicted in standardized representation format.

Inline ECO terminals are approved for the temperature range from 0°C to +55°C. The electronics base and Inline connector are supplied as standard.

Features

- 4 differential inputs for thermocouples
- Measuring range: -270 °C ... +1372 °C
- Connection of sensors in 2-wire technology
- Diagnostic information in the process data word
- Diagnostic indicator



This data sheet is only valid in association with the IL SYS INST UM E user manual.



Make sure you always use the latest documentation. It can be downloaded from the product at phoenixcontact.net/products.

2	Table of contents	
1	Description	1
2	Table of contents	2
3	Ordering data	3
4	Technical data	4
5	Additional technical data.....	6
	5.1 Measuring ranges of the TC inputs.....	6
	5.2 Maximum permissible cable lengths	6
	5.3 Tolerances of the measuring inputs at TA = +25°C	7
	5.4 Additional switch-on tolerances	7
	5.5 Tolerances of the internal cold junction	7
	5.6 Additional tolerances influenced by electromagnetic interference	7
6	Internal circuit diagram	8
7	Electrical isolation.....	8
8	Terminal point assignment.....	9
9	Connection example.....	9
10	Installation instructions	9
11	Connection notes	9
12	Local diagnostic indicator	9
13	Process data.....	10
14	Representation of measured values	10

3 Ordering data

Description	Type	Order No.	Pcs./Pkt.
Inline ECO, Temperature measurement terminal, Analog UTH inputs: 4 (type K), Connection method: 2-wire, Transmission speed in the local bus 500 kBit/s, Degree of protection IP20, including Inline connector	IB IL UTH 4/K-ECO	2702503	1
Accessories	Type	Order No.	Pcs./Pkt.
Shield connection clamp, for shield on busbars, contact resistance < 1 mΩ (Assembly)	SK 8	3025163	10
Shield connection clamp, for shield on busbars, contact resistance < 1 mΩ (Assembly)	SK 14	3025176	10
Shield connection clamp, for shield on busbars, contact resistance < 1 mΩ (Assembly)	SK 20	3025189	10
Shield connection clamp, for shield on busbars, contact resistance < 1 mΩ (Assembly)	SK 35	3026463	10
Support bracket for busbars (Assembly)	AB-SK	3025341	10
Support bracket, Bracket for busbars, set every 20 cm, Length: 95.5 mm, Width: 6.2 mm, Color: gray (Assembly)	AB-SK 65	3026489	10
Support bracket, Bracket for busbars, set every 20 cm, Length: 10 mm, Width: 56 mm, Height: 20 mm, Color: silver (Assembly)	AB-SK/E	3026476	10
PEN conductor busbar, 3mm x 10 mm, length: 1000 mm (Assembly)	NLS-CU 3/10 SN 1000MM	0402174	10
Connection terminal block, Connection method Screw connection, Cross section: 0.5 mm ² - 6 mm ² , Width: 7 mm, Color: silver	AK 4	0404017	50
Connection terminal block, Connection method Screw connection, Cross section: 0.5 mm ² - 6 mm ² , Width: 7 mm, Color: green-yellow	AKG 4 GNYE	0421029	50
Connection terminal block, Connection method Screw connection, Cross section: 0.5 mm ² - 6 mm ² , Width: 7 mm, Color: black	AKG 4 BK	0421032	50
Connector, for digital 1, 2 or 8-channel Inline terminals (Connector/Adapter)	IB IL SCN-8	2726337	10
Labeling field, width: 12.2 mm (Marking)	IB IL FIELD 2	2727501	10
Thermoelectric voltage terminal block pair, USA type K, Connection method: Screw connection, Number of positions: 1, Cross section: 0.2 mm ² - 4 mm ² , AWG: 24 - 12, Width: 10.4 mm, Color: gray, Mounting type: NS 35/7,5, NS 35/15, NS 32	MTKD-NICR/NI	3100062	50
Documentation	Type	Order No.	Pcs./Pkt.
User manual, English, Automation terminals of the Inline product range	IL SYS INST UM E	-	-
Data sheet, English, INTERBUS addressing	DB GB IBS SYS ADDRESS	-	-

4 Technical data

Dimensions (nominal sizes in mm)

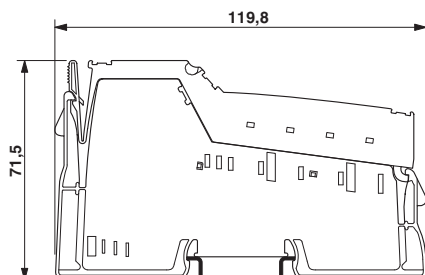

Width	12.2 mm
Height	119.8 mm
Depth	71.5 mm

General data

Color	green
Weight	65 g (with connector)
Ambient temperature (operation)	0 °C ... 55 °C
Ambient temperature (storage/transport)	-25 °C ... 85 °C
Permissible humidity (operation)	10 % ... 95 % (according to DIN EN 61131-2)
Permissible humidity (storage/transport)	10 % ... 95 % (according to DIN EN 61131-2)
Air pressure (operation)	70 kPa ... 106 kPa (up to 3000 m above sea level)
Air pressure (storage/transport)	70 kPa ... 106 kPa (up to 3000 m above sea level)
Degree of protection	IP20
Protection class	III, IEC 61140, EN 61140, VDE 0140-1

Connection data

Designation	Inline connector
Connection method	Spring-cage connection
Conductor cross section solid / stranded	0.08 mm ² ... 1.5 mm ² / 0.08 mm ² ... 1.5 mm ²
Conductor cross section [AWG]	28 ... 16
Stripping length	8 mm

Interface Inline local bus

Number	2
Connection method	Inline data jumper
Transmission speed	500 kBit/s

Inline potentials / Power consumption

Communications power U_L	7.5 V DC (via voltage jumper)
Current consumption from U_L	typ. 38 mA max. 55 mA
I/O supply voltage U_{ANA}	24 V DC
Current consumption from U_{ANA}	typ. 32 mA max. 39 mA
Power consumption	typ. 1.05 W (total) max. 1.35 W (total)

Analog UTH inputs

Number of inputs	4 (type K)
Connection method	Inline connector
Connection method	2-wire
Sensor types that can be used (TC)	K
Resolution A/D	24 bit
A/D conversion time	typ. 120 ms
Scan repeat time	typ. 650 ms (all four measuring channels)
Measuring principle	Sigma/Delta process
Measured value representation	16 bits (15 bits + sign bit)
Relative accuracy	typ. $\pm 0.2\%$ (of measuring range final value, incl. tolerance of the cold junction)
Absolute accuracy	typ. ± 1.9 K (Reference junction)
Transient protection of inputs	yes
Input resistance:	typ. 5 M Ω (with I/O supply voltage present)
Voltage at the TC input	max. 40 V DC (1 min.)

Programming Data

ID code (hex)	7E
ID code (dec.)	126
Length code (hex)	04
Process data channel	64 Bit
Input address area	8 Byte
Output address area	0 Byte
Parameter channel (PCP)	0 Byte
Register length (bus)	64 Bit

Configuration and parameter data in a PROFIBUS system

Required parameter data	1 Byte
Need for configuration data	4 Byte

Error messages to the higher level control or computer system

Failure of the internal I/O supply	I/O error message sent to the bus coupler
Checksum error	I/O error message sent to the bus coupler

Electrical isolation/isolation of the voltage areas	
Test section	Test voltage
Bus logic (local bus, communications power)	500 V AC, 50 Hz, 1 min.
Analog I/O	500 V AC, 50 Hz, 1 min.
Functional earth ground	500 V AC, 50 Hz, 1 min.

Conformance with EMC Directive 2014/30/EU

Noise immunity test in accordance with EN 61000-6-2

Electrostatic discharge (ESD) EN 61000-4-2/ IEC 61000-4-2	Criterion B, 6 kV contact discharge, 8 kV air discharge
Electromagnetic fields EN 61000-4-3/IEC 61000-4-3	Criterion A, Field intensity: 10 V/m
Fast transients (burst) EN 61000-4-4/IEC 61000-4-4	Criterion B, 2 kV
Transient overvoltage (surge) EN 61000-4-5/ IEC 61000-4-5	Criterion B, supply lines DC: ± 1 kV/ ± 1 kV (symmetrical/ asymmetrical), shielded I/O cables: ± 1 kV
Conducted interference EN 61000-4-6/IEC 61000-4-6	Criterion A; Test voltage 10 V

Noise emission test according to EN 61000-6-3

Radio interference properties EN 55022	Class A
--	---------

Approvals

For the latest approvals, please visit phoenixcontact.net/products.

5 Additional technical data

5.1 Measuring ranges of the TC inputs

Sensor type	Standard	Measuring range	
		Lower limit	Upper limit
K	DIN EN 60584	-270 °C	+1372 °C

5.2 Maximum permissible cable lengths

Connecting cable and maximum cable length specifications

Maximum permissible cable length	Sensor type	Connection method	Sensor cable	Cable type
100 m	TC inputs channel 1 ... 4	2-wire	Shielded, twisted	TC sensor cable or equalizing conductor (according to DIN EN 60584-3, IEC 60584-3, DIN 43722)

TC inputs: select the appropriate TC equalizing conductors for TC sensors (according to DIN EN 60584-3, IEC 60584-3, and DIN 43722).

The maximum cable length specification is valid from the sensor to the connection terminal block and includes the maximum specified tolerances.

The measuring tolerances of all channels will only be observed if the permissible cable types are used.

Corresponding thermoelectric voltage terminal blocks are available for extending the cable, see accessories ordering data.

5.3 Tolerances of the measuring inputs at $T_A = +25^\circ\text{C}$

(including tolerances of the cold junction)

Sensor type	Measuring range final value	Tolerance			
		Absolute		Relative	
		Typ.	Max.	Typ.	Max.
K	+1372 °C	±2.7 K	±5.5 K	0.20 %	0.40 %

The specified tolerances apply under the following framework conditions:

- Nominal operation in the preferred mounting position
- Thermally steady system without external heat influence, e.g., thanks to installation in a control box
- Preheating time > 15 minutes with active bus
Observe the specified, short-term switch-on tolerances.
- In the range below measuring temperature $T_M = -100^\circ\text{C}$, the specified tolerances are doubled due to the low sensitivity of the sensor elements.
- The typical tolerance values are measured practical values, based on the maximum spread of all test objects.
- The maximum tolerance values represent the worst-case measurement inaccuracy. They contain the theoretical maximum possible tolerances in the corresponding measuring ranges. The theoretical maximum possible tolerances of the calibration and test equipment have also been taken into consideration.
- For the last IB IL UTH4/K-ECO terminal within the Inline station, the typical tolerances can be improved upon by around 0.9 K by using another Inline terminal after this terminal.

5.5 Tolerances of the internal cold junction

Cold junction (CJ)	Measuring range T_{CJ} (cold junction temperature)	Absolute tolerance	
		Typ.	Max.
Internal detection	0 °C ... 55 °C	±1.9 K	±3.8 K

5.6 Additional tolerances influenced by electromagnetic interference

Type of electromagnetic interference	Standard	Additional tolerances of measuring range final value
Electromagnetic fields	EN 61000-4-3/ IEC 61000-4-3	< ±1.0 %
Fast transients (burst)	EN 61000-4-4/ IEC 61000-4-4	< ±1.0 %
Conducted interference	EN 61000-4-6/ IEC 61000-4-6	< ±1.0 %

5.4 Additional switch-on tolerances

Transient period	Additional tolerance
	Typ.
5 minutes	±3.5 K
10 minutes	±2.0 K
15 minutes	±1.5 K
20 minutes	±0.1 K

6 Internal circuit diagram

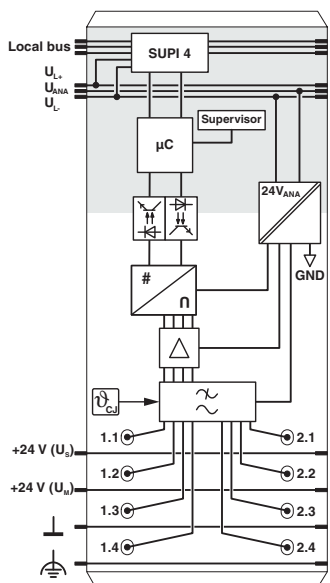
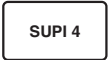











Figure 1 Internal wiring of the terminal points

Key:

	Protocol chip
	Microprocessor
	Hardware monitoring
	Optocoupler
	Power supply unit with electrical isolation
	Power supply unit
	Analog/digital converter
	Input amplifier
	Low pass filter
	Cold junction (CJ)
	Electrically isolated area

7 Electrical isolation

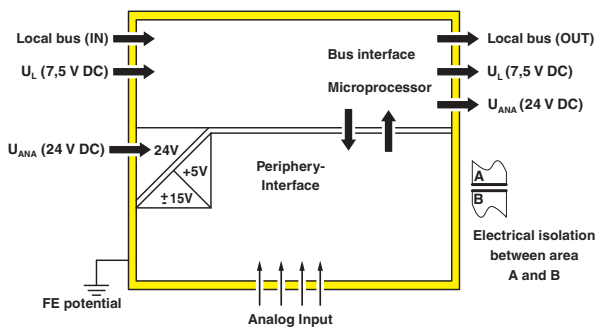

Figure 2 Electrical isolation of the individual function areas

8 Terminal point assignment

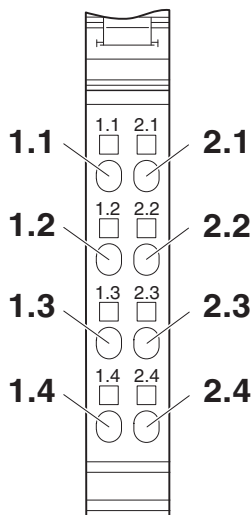

Figure 3 Terminal point assignment

Terminal point	Signal	Terminal point	Signal
1.1	IN01+	2.1	IN01-
1.2	IN02+	2.2	IN02-
1.3	IN03+	2.3	IN03-
1.4	IN04+	2.4	IN04-

9 Connection example

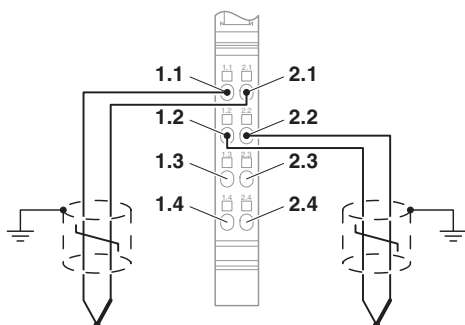

Figure 4 Connecting the sensors

10 Installation instructions

High current flowing through potential jumpers U_M and U_S leads to a temperature rise in the potential jumpers and inside the terminal. To keep the current flowing through the potential jumpers of the analog terminals as low as possible, always place the analog terminals after all the other terminals at the end of the main circuit (for the sequence of the Inline terminals: see also IL SYS INST UM E user manual).

Please note for this terminal that due to potential routing the current always distorts the temperature of the internal cold junction. Therefore, position this terminal after all of the other terminals to minimize the current flowing through all potential jumpers.

11 Connection notes

Connecting the thermocouples

Always connect the analog sensors using shielded, twisted pair cables.

Use encapsulated thermocouples.

Thermoelectric voltage terminal blocks are available for extending thermocables (Phoenix Contact MTKD type, see ordering data).

Connecting the shield

Connect the shielding with the shielding accessories given in the ordering data.

12 Local diagnostic indicator



Figure 5 Local diagnostic indicator

Designation	Color	Meaning
D	green	Diagnostics (bus and logic voltage)



For detailed information on diagnostics, please refer to the IL SYS INST UM E user manual.

13 Process data

The terminal uses four words of IN process data.

Each channel is mapped to a word.

The measured values are transmitted to the controller board or the computer using process data input words.

The resolution is 0.1 K per bit.

Order of the process data words

Word	0	1	2	3
Signal	IN01	IN02	IN03	IN04
Value	AV01	AV02	AV03	AV04

AV Analog value

The measured values are depicted in standardized representation format.

In this format, data is standardized to the measuring range and represented in such a way that it indicates the corresponding value without conversion.

The measured value is represented in bits 14 to 0. An additional bit (bit 15) is available as a sign bit.

15	14	13	12	11	10	9	8	7	6	5	4	3	2	1	0
V	Analog value														

V Sign bit

In standardized representation format, a diagnostic code is mapped to the input data in the event of an error.

Code (hex)	Cause
8001	Measuring range exceeded (overrange)
8002	Open circuit
8004	Measured value invalid or no valid measured value available
8008	Cold junction defective
8010	Parameter table invalid
8020	Faulty supply voltage
8040	Device faulty
8080	Below measuring range (underrange)

If the supply voltage is not present, the terminal generates an I/O error message in addition to the diagnostic code.

14 Representation of measured values

Input data		Sensor type K
hex	dec	°C
8001	Measuring range exceeded (overrange)	> upper limit value
03E8	1000	+100.0
0001	1	+0.1
0000	0	0
FFFF	-1	-0.1
FC18	-1000	-100.0
8080	Below measuring range (underrange)	< lower limit value



SCATTERGOOD & JOHNSON LTD

ELECTRICAL ENGINEERING & FLUID CONTROL DISTRIBUTORS

Est.1899

At Scattergood & Johnson Ltd, we pride ourselves on being a technical distributor to specialist industries.

Working with a range of quality product suppliers across a number of specialist markets, we are not your average 'box shifter' - we are your technical and supply chain partner.

We fully support every product we sell - for free! Our internal team and external sales engineers can answer any product or application question, no matter the complexity.

Backing up this technical ability is a range of 50,000+ products available from stock for nationwide next day delivery (same day if required!), or you can collect what you need from any of our trade counters around the UK.

Select your specialist interest below to learn more about how we can help.



Online, In Branch and On the Road - Scattergood & Johnson Ltd, there when you need us.

www.scatts.co.uk