

Uninterruptible power supply - QUINT-UPS/ 24DC/ 24DC/20 - 2320238

Please be informed that the data shown in this PDF Document is generated from our Online Catalog. Please find the complete data in the user's documentation. Our General Terms of Use for Downloads are valid (<http://phoenixcontact.com/download>)



Uninterruptible power supply with IQ technology for DIN rail mounting, input: 24 V DC, output: 24 V DC/20 A, including mounted universal DIN rail adapter UTA 107/30

Product Description

The UPS module for 24 V DC with output currents ranging from 5 to 40 A allows you to create a custom solution combining a power supply, UPS module, and energy storage.

Your advantages

- ✓ Easy handling thanks to automatic battery detection, tool-free battery replacement during operation, and communication via the IFS interface
- ✓ Optimum use of the buffer time and preventive monitoring of the energy storage
- ✓ Rapid battery charging
- ✓ Comprehensive signaling and parameterization
- ✓ Fast tripping of standard circuit breakers with SFB (selective fuse breaking) technology
- ✓ Reliable starting of difficult loads with the static POWER BOOST power reserve with up to 1.5 times the nominal current permanently



Key Commercial Data

Packing unit	1 pc
GTIN	 4 046356 554190
GTIN	4046356554190
Weight per Piece (excluding packing)	600.000 g
Custom tariff number	85371091
Country of origin	China

Technical data

Dimensions

Width	40 mm
Height	130 mm
Depth	125 mm
Width with alternative assembly	123 mm
Height with alternative assembly	130 mm

Uninterruptible power supply - QUINT-UPS/ 24DC/ 24DC/20 - 2320238

Technical data

Dimensions

Depth with alternative assembly	43 mm
---------------------------------	-------

Ambient conditions

Degree of protection	IP20
Ambient temperature (operation)	-25 °C ... 70 °C
Ambient temperature (storage/transport)	-40 °C ... 85 °C
Max. permissible relative humidity (operation)	≤ 95 % (25 °C, non-condensing)
Climatic class	3K3 (in acc. with EN 60721)

Input data

Input voltage	24 V DC
Nominal input voltage	24 V DC
Input voltage range	18 V DC ... 30 V DC
Current consumption (maximum)	32.9 A (maximum, mains operation)
Current consumption (charging process)	6.9 A (Charging, mains operation)
Fixed backup threshold	≤ 22 V DC
Variable connect threshold	1 V/0.1 s

Output data (24 V DC mains operation)

Nominal output voltage	24 V DC
Output voltage range (depends on the input voltage)	18 V DC ... 30 V DC
Nominal output current (I_N)	20 A (-25 °C ... 60 °C)
POWER BOOST (I_{Boost})	26 A (-25 °C ... 40 °C)
Selective Fuse Breaking (I_{SFB})	120 A (-25 °C ... 60 °C)

Output data (24 V DC battery operation)

Nominal output voltage	24 V DC
Output voltage range (depends on the input voltage)	19.2 V DC ... 27.6 V DC ($U_{OUT} = U_{BAT} - 0.5 \text{ V DC}$)
Nominal output current (I_N)	20 A (-25 °C ... 60 °C)
POWER BOOST (I_{Boost})	27 A (-25 °C ... 40 °C)
Selective Fuse Breaking (I_{SFB})	120 A (-25 °C ... 60 °C)

General output data

Efficiency	> 98 % (Mains operation, with charged energy storage)
------------	---

General

IQ technology	Yes
Net weight	0.6 kg
Protection class	III
MTBF (IEC 61709, SN 29500)	> 500000 h (40 °C)
Mounting position	horizontal DIN rail NS 35, EN 60715
Assembly instructions	alignable: horizontal 5 mm, vertical 50 mm

Connection data, input

Uninterruptible power supply - QUINT-UPS/ 24DC/ 24DC/20 - 2320238

Technical data

Connection data, input

Connection method	Screw connection
Conductor cross section solid min.	0.2 mm ²
Conductor cross section solid max.	6 mm ²
Conductor cross section flexible min.	0.2 mm ²
Conductor cross section flexible max.	4 mm ²
Conductor cross section AWG min.	12
Conductor cross section AWG max.	10
Stripping length	8 mm
Screw thread	M4

Connection data, output

Connection method	Screw connection
Conductor cross section solid min.	0.2 mm ²
Conductor cross section solid max.	6 mm ²
Conductor cross section flexible min.	0.2 mm ²
Conductor cross section flexible max.	4 mm ²
Conductor cross section AWG min.	12
Conductor cross section AWG max.	10
Stripping length	8 mm
Screw thread	M4

Connection data for signaling

Conductor cross section solid min.	0.2 mm ²
Conductor cross section solid max.	4 mm ²
Conductor cross section flexible min.	0.2 mm ²
Conductor cross section flexible max.	2.5 mm ²
Conductor cross section AWG min.	24
Conductor cross section AWG max.	12
Screw thread	M4

Standards

EMC requirements for noise immunity	EN 61000-6-1
	EN 61000-6-2
EMC requirements for noise emission	EN 61000-6-3
	EN 61000-6-4
Standard - Electrical safety	EN 60950-1/VDE 0805 (SELV)
Standard – Electronic equipment for use in electrical power installations and their assembly into electrical power installations	EN 50178/VDE 0160 (PELV)
Rail applications	EN 50121-4

Conformance/approvals

UL approvals	UL Listed UL 508
	UL/C-UL Recognized UL 60950-1

Uninterruptible power supply - QUINT-UPS/ 24DC/ 24DC/20 - 2320238

Technical data

Conformance/approvals

	UL ANSI/ISA-12.12.01 Class I, Division 2, Groups A, B, C, D (Hazardous Location)
--	--

EMC data

Electromagnetic compatibility	Conformance with EMC Directive 2014/30/EU
Low Voltage Directive	Conformance with LV directive 2006/95/EC
Electrostatic discharge	EN 61000-4-2
Contact discharge	8 kV (Test Level 4)
Discharge in air	15 kV (Test Level 4)
Electromagnetic HF field	EN 61000-4-3
Frequency range	80 MHz ... 1 GHz
Test field strength	20 V/m
Frequency range	1 GHz ... 3 GHz
Test field strength	10 V/m
Frequency range	2 GHz ... 3 GHz
Test field strength	3 V/m
Comments	Criterion A
Fast transients (burst)	EN 61000-4-4
Input	2 kV (Test Level 3 - asymmetrical)
Output	2 kV (Test Level 3 - asymmetrical)
Signal	2 kV (Test Level 4 - asymmetrical)
Comments	Criterion A
Surge voltage load (surge)	EN 61000-4-5
Input	1 kV (Test Level 2 - symmetrical)
	2 kV (Test Level 3 - asymmetrical)
Output	1 kV (Test Level 2 - symmetrical)
	2 kV (Test Level 3 - asymmetrical)
Signal	1 kV (Test Level 2 - asymmetrical)
Comments	Criterion A
I/O/S	asymmetrical
Frequency range	0.15 MHz ... 80 MHz
Voltage	10 V (Test Level 3)
Comments	Criterion A
Criterion A	Normal operating behavior within the specified limits.
Criterion B	Temporary impairment to operational behavior that is corrected by the device itself.

Environmental Product Compliance

REACH SVHC	Lead 7439-92-1
China RoHS	Environmentally Friendly Use Period = 25;
	For details about hazardous substances go to tab "Downloads", Category "Manufacturer's declaration"

Uninterruptible power supply - QUINT-UPS/ 24DC/ 24DC/20 - 2320238

Drawings

Block diagram

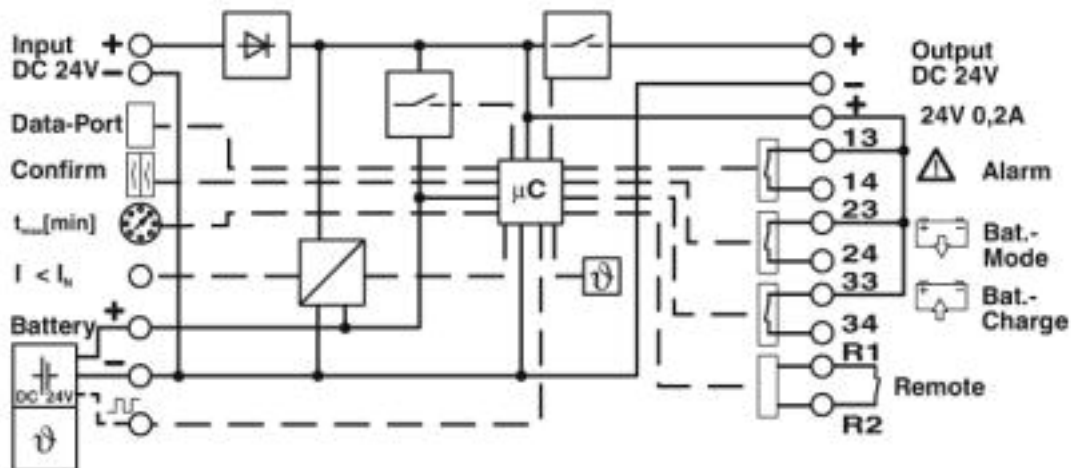

Classifications

eCl@ss

eCl@ss 4.0	27040600
eCl@ss 4.1	27040600
eCl@ss 5.0	27040600
eCl@ss 5.1	27040600
eCl@ss 6.0	27040600
eCl@ss 7.0	27040603
eCl@ss 8.0	27040603
eCl@ss 9.0	27040705

ETIM

ETIM 3.0	EC001039
ETIM 4.0	EC000382
ETIM 5.0	EC000382
ETIM 6.0	EC000382
ETIM 7.0	EC000382

UNSPSC

UNSPSC 6.01	30211510
UNSPSC 7.0901	39121011
UNSPSC 11	39121011
UNSPSC 12.01	39121011
UNSPSC 13.2	39121011



Uninterruptible power supply - QUINT-UPS/ 24DC/ 24DC/20 - 2320238

Approvals

Approvals







Approvals

DNV GL / PRS / BV / LR / ABS / UL Listed / UL Recognized / cUL Recognized / cUL Listed / EAC / EAC / UL Recognized / LR / UL Listed / cUL Listed / cUL Recognized / ABS / PRS / EAC / DNV GL / BV / EAC

Ex Approvals











UL Listed / cUL Listed / UL Listed / cUL Listed / cULus Listed

Approval details

DNV GL		https://approvalfinder.dnvgl.com/	TAA0000265
Nominal voltage UN		500 V	
Nominal current IN		41 A	
mm ² /AWG/kcmil		6	
PRS		http://www.prs.pl/	TE/2103/880590/16
BV		http://www.veristar.com/portal/veristarinfo/generalinfo/approved/approvedProducts/equipmentAndMaterials	41516/A0 BV
LR		http://www.lr.org/en	17/20032
ABS		http://www.eagle.org/eagleExternalPortalWEB/	15-GD1438179-PDA
UL Listed		http://database.ul.com/cgi-bin/XYV/template/LISEXT/1FRAME/index.htm	FILE E 123528
UL Recognized		http://database.ul.com/cgi-bin/XYV/template/LISEXT/1FRAME/index.htm	FILE E 211944

Uninterruptible power supply - QUINT-UPS/ 24DC/ 24DC/20 - 2320238

Approvals

cUL Recognized		http://database.ul.com/cgi-bin/XYV/template/LISEXT/1FRAME/index.htm	FILE E 211944
cUL Listed		http://database.ul.com/cgi-bin/XYV/template/LISEXT/1FRAME/index.htm	FILE E 123528
EAC			EAC-Zulassung
EAC			EAC-Zulassung
UL Recognized		http://database.ul.com/cgi-bin/XYV/template/LISEXT/1FRAME/index.htm	FILE E 211944
LR		http://www.lr.org/en	17/20032
UL Listed		http://database.ul.com/cgi-bin/XYV/template/LISEXT/1FRAME/index.htm	FILE E 123528
cUL Listed		http://database.ul.com/cgi-bin/XYV/template/LISEXT/1FRAME/index.htm	FILE E 123528
cUL Recognized		http://database.ul.com/cgi-bin/XYV/template/LISEXT/1FRAME/index.htm	FILE E 211944
ABS		http://www.eagle.org/eagleExternalPortalWEB/	15-GD1438179-PDA
PRS		http://www.prs.pl/	TE/2103/880590/16



Uninterruptible power supply - QUINT-UPS/ 24DC/ 24DC/20 - 2320238

Approvals

EAC			RU C- DE.A*30.B.01082
-----	--	--	--------------------------

DNV GL		https://approvalfinder.dnvgl.com/	TAA0000265
Nominal voltage UN		500 V	
Nominal current IN		41 A	
mm ² /AWG/kcmil		6	

BV		http://www.veristar.com/portal/veristarinfo/generalinfo/approved/approvedProducts/equipmentAndMaterials	41516/A0 BV
----	--	---	-------------

EAC			RU C- DE.A*30.B.01082
-----	--	--	--------------------------



SCATTERGOOD & JOHNSON LTD

ELECTRICAL ENGINEERING & FLUID CONTROL DISTRIBUTORS

Est.1899

At Scattergood & Johnson Ltd, we pride ourselves on being a technical distributor to specialist industries.

Working with a range of quality product suppliers across a number of specialist markets, we are not your average 'box shifter' - we are your technical and supply chain partner.

We fully support every product we sell - for free! Our internal team and external sales engineers can answer any product or application question, no matter the complexity.

Backing up this technical ability is a range of 50,000+ products available from stock for nationwide next day delivery (same day if required!), or you can collect what you need from any of our trade counters around the UK.

Select your specialist interest below to learn more about how we can help.



Online, In Branch and On the Road - Scattergood & Johnson Ltd, there when you need us.

www.scatts.co.uk