

Power Supplies



User Manual

UPS-CONF

Order No.: -

Configuration and Management Software
UPS-CONF

Power Supplies

User Manual

Configuration and Management Software UPS-CONF

2012-07-02

Designation: UPS-CONF

Revision: 01

Order No.: -

This manual is valid for:

Designation
UPS-CONF

Order No.
2320403

Please observe the following notes

In order to ensure the safe use of the product described, you have to read and understand this manual. The following notes provide information on how to use this manual.



The pictured products do always exemplify the concerned topic.

Target audience for this documentation

The use of products described here solely addresses persons, who are qualified and familiar with electrical equipment and the appropriate and relevant safety concepts. Please also read the section titled "Qualified personnel" in the topic titled "Important safety notes (see page 10)".

Phoenix Contact accepts no liability for erroneous handling or damage to products from Phoenix Contact or third-party products resulting from disregard of information contained in this documentation.

Explanation of symbols used and signal words



DANGER

The danger symbol is used to indicate instructions where non-compliance may result in damage to hardware/software or personal injury (in indirect connection with dangerous process peripherals).



NOTE

The note symbol precedes notes that must be strictly observed in order to ensure error-free operation. It also gives you tips and advice on the efficient use of hardware and on software optimization to save you extra work.



The "Additional Details" symbol indicates cross references (hypertext links or bibliographical references) which lead to detailed descriptions of a term or additional details on the context in question.

General terms and conditions of use for technical documentation

Phoenix Contact reserves the right to alter, correct, and/or improve the technical documentation and the products described in the technical documentation at any time and without giving prior notice, insofar as this is reasonable for the user. The same applies to any technical changes that serve the purpose of technical progress. Technical documentation does not contain any guarantees regarding quality, does not describe any fair marketable quality, and does not make any claims in terms of quality guarantees or guarantees regarding suitability for a specific purpose.

The receipt of technical documentation (data sheets, installation instructions, manuals, online help, etc.) does not constitute any further duty on the part of Phoenix Contact to furnish information on alterations to products and/or technical documentation. Any other agreement shall only apply if expressly confirmed in writing by Phoenix Contact.

Please note that the supplied documentation is intended to serve as product-specific documentation only and that you are responsible for checking the suitability and intended use of the products in your specific application, in particular with regard to observing the applicable standards and directives. Although Phoenix Contact makes every effort to ensure that the information and content is accurate, up-to-date, and refers to the state of the art, technical inaccuracies and/or printing errors in the information cannot be ruled out. Phoenix Contact does not offer any guarantees as to the reliability, accuracy or completeness of the information. All information made available in the technical documentation is supplied without any accompanying guarantee, whether expressly mentioned, implied or tacitly assumed.

Phoenix Contact accepts no liability or responsibility for errors or omissions in the content of the technical documentation (data sheets, installation instructions, manuals, online help, etc.).

The aforementioned limitations of liability and exemptions from liability do not apply insofar as liability must be assumed, e.g., in accordance with product liability law, in cases of premeditation, gross negligence, on account of loss of life, physical injury or damage to health, or on account of the violation of important contractual obligations. Claims for damages for the violation of important contractual obligations are, however, limited to contract-typical, predictable damages, provided there is no premeditation or gross negligence, or unless liability is assumed on account of loss of life, physical injury, or damage to health. This ruling does not imply a change in the burden of proof to the detriment of the user.

Statement of legal authority

This documentation, including all illustrations contained herein, is copyright protected. This documentation is to be used for its intended purpose only. All other means of usage are prohibited. Reproduction, translation, and public disclosure, as well as electronic and photographic archiving and modification, require written consent by Phoenix Contact. Violators are liable for damages.

Phoenix Contact reserves all rights in the case of patent award or listing of a registered design. Third-party products are always named without reference to patent rights. The existence of such rights shall not be excluded.

How to contact us

Internet

Up-to-date information on Phoenix Contact products and our Terms and Conditions can be found on the Internet at:

www.phoenixcontact.com

Make sure you always use the latest documentation.

It can be downloaded at:

www.phoenixcontact.net/catalog

UPS-CONF

Subsidiaries

If there are any problems that cannot be solved using the documentation, please contact your Phoenix Contact subsidiary. Subsidiary contact information is available at:
www.phoenixcontact.com

Table of Contents

1	Functional overview.....	1
2	Software setup	3
	2.1 System requirements.....	4
	2.2 Installation.....	5
	2.3 Software settings.....	5
3	Hardware overview.....	7
	3.1 Important safety notes.....	10
4	Hardware setup.....	11
	4.1 Buffer time selection.....	12
	4.2 Data port.....	13
	4.3 Connecting the PC.....	14
5	Software overview.....	15
	5.1 User interface.....	15
	5.2 Status bar.....	17
6	Status - Reported information.....	20
	6.1 System.....	20
	6.2 Battery.....	25
	6.3 Battery Advanced.....	26
	6.4 UPS.....	27
	6.5 UPS Advanced.....	28
7	Settings - Defining UPS device parameters.....	29
	7.1 Reporting.....	31
	7.2 Time Setting.....	36
	7.3 Service.....	39
	7.4 Advanced.....	41
8	Monitoring - Statistics and logging.....	44
9	Stick usage.....	45
	9.1 Configuration stick usage.....	46
	9.2 Service stick usage - service mode.....	47
10	Application samples.....	52

UPS-CONF

	10.1	Functional test.....	52
	10.2	PC-Mode: PC shutdown and restart.....	52
11		Troubleshooting.....	53
	11.1	Unexpected status symbols.....	54
	11.2	Communication port.....	56
		Index	57

1 Functional overview

UPS-CONF is a management software to configure and monitor QUINT-UPS devices, that come with the IQ technology.

This technology with continuous battery monitoring and intelligent management provides you with information about the charging state, remaining runtime, and service life of your battery at all times. Intelligent communication informs you when a situation becomes critical. This reduces the amount of maintenance involved and increases your system availability.

IQ technology means

- Intelligent Battery Control: automatically detects the connected battery type and maximizes the remaining service life of the battery unit via an optimally adapted charging characteristic.
- Intelligent Battery Management: continuous status information is shown for
 - SOC (State of Charge): current charging state and remaining back-up time of the battery unit
 - SOH (State of Health): remaining life expectancy of the battery unit, provides early warning for a potential battery unit failure
 - SOF (State of Function): determines the current performance of the battery unit.
- Intelligent Charging: adapts the charging current and thereby ensures the fastest possible recharging and availability.
- Intelligent communication: the communication of UPS and PC allows configuration, extensive signaling and parameterization.



The IQ technology also works without UPS-CONF. With this software you have an easier monitoring and configurations can be done.



The UPS-CONF software is intended for a PC as well as an IPC (Industrial PC). In this documentation the term "PC" is used to address both.



The configurable QUINT-UPS device is also referred to as the "UPS" in this documentation.

Features supported by the UPS-CONF software

In order to optimally support the IQ technology, UPS-CONF provides the following features:

- Clear overview about condition of mains, battery, UPS device and connection from PC to UPS
- Automatic PC shutdown and restart functionality while the UPS runs in PC-Mode
- Start of application specific programs for system shutdown
- Configuration of switching outputs
- Chronological event logging
- Setting of customized parameters like the maximum charging current
- Choice of user interface language in the Software settings (see page 5).
Currently supported languages: English, German



The topic titled Application samples (see page 52) guides through some typical scenarios.

2 Software setup

The UPS-CONF software has to be installed on a PC in order to configure and monitor an UPS system. If the buffered load is a PC, the UPS can be operated in the PC-Mode to additionally enable the automatic PC shutdown and restart functionality.

To setup the software, the following steps have to be executed:

1. Make sure all system requirements (see page 4) for the hardware and software are met.
2. Download and install the software (see page 5).
3. Follow the steps in the hardware setup (see page 11).
4. Start the software (see page 15).
5. Become familiar with the software settings (see page 5) supported by the UPS-CONF software and carry out the required settings.

2.1 System requirements

In order to run the UPS-CONF software, your computer must meet the following software and hardware requirements:

Software requirements

- Supported operating systems:
 - Windows 7, 32bit and 64bit
 - Windows Vista SP1
 - XP SP3 (requires .NET Framework 3.5 SP1)
- Supported browser: Internet Explorer version 6 or later

Hardware requirements		
CPU	1 GHz min. 2 GHz recommended	Windows 7 Windows Vista SP1
	Pentium III 1GHz min. 2 GHz recommended	Windows XP SP3
Main memory	1 GB RAM min. 2 GB RAM recommended	Windows 7 Windows Vista SP1
	512 MB RAM min. 1 GB RAM recommended	Windows XP SP3
Main memory used by UPS-CONF	max. 96 MB	
Hard disk drive (recommended)	850 MB	
Hard disk used by UPS-CONF	max. 50 MB	
CD-ROM drive	not necessarily needed	
Interfaces	1 x USB 2.0	
Monitor	VGA, resolution 800 x 600 pixels minimum, 256 colors	
Network	Internet connection needed for program download	

2.2 Installation



The UPS-CONF configuration and management software can be downloaded free of charge at www.phoenixcontact.net/catalog.

To install the software, proceed as follows:

1. Find UPS-CONF at www.phoenixcontact.net/catalog.
2. Save the UPS-CONF_Setup_v....exe file to the preferred download folder.
3. Make sure the IFS-USB-DATACABLE is unplugged.
4. Install UPS-CONF from the selected download folder. Simply follow the screen instructions.
Read the EULA (End User License Agreement) carefully when it is displayed and agree it to continue the installation.
5. After having completed the UPS-CONF installation, connect the UPS device to the PC (see page 14). If required, select PC-Mode as operating mode (see page 12).
6. As soon as Windows detects the new USB hardware follow the instructions of the driver installation.

2.3 Software settings

The software settings can be shown by clicking the "Software settings" item in the system menu.

UPS-CONF

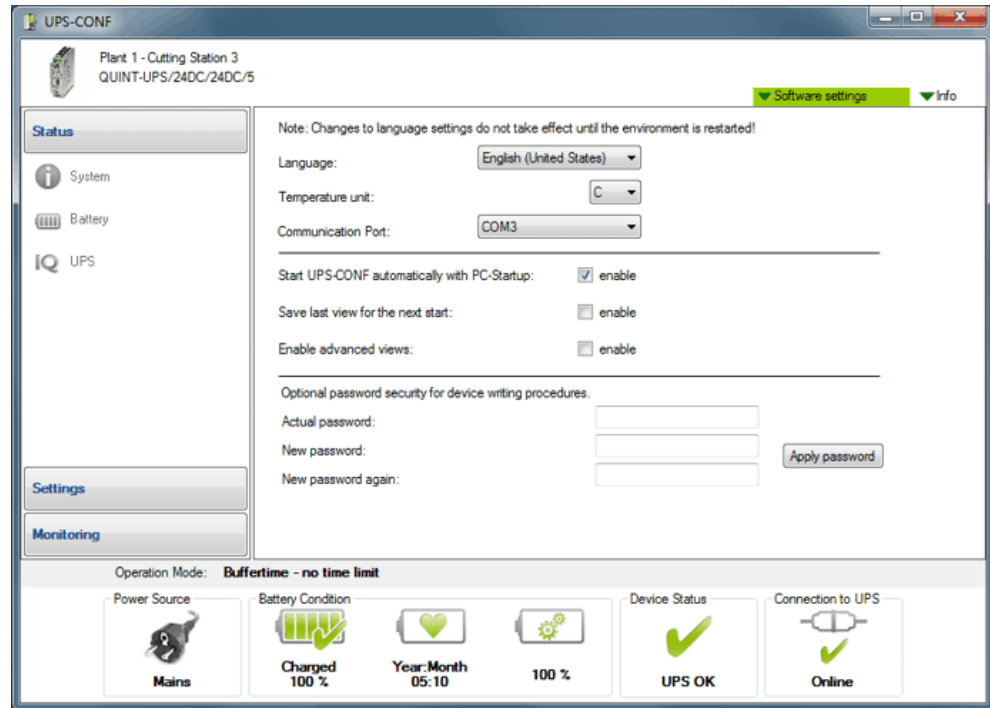

The following settings can be defined:

- Language of the user interface (English, German)



NOTE

To apply the changed language setting, you have to restart the UPS-CONF software.

- Temperature unit (Celsius, Kelvin, Fahrenheit)
- Communication (USB) port at the PC for the IFS-USB-DATACABLE (COMx)



Normally, the communication port is set automatically by the UPS-CONF software when connecting the UPS devices. Under normal conditions there is no need to change this setting. If it has not been set automatically during the software installation, refer to the section Communication port (see page 56) in the Troubleshooting topic.

- Enable/disable automatic UPS-CONF startup after PC startup. This option must be checked if the UPS device shall buffer this PC.
- Restore the last view after the next software start.
- Hide or show the advanced views ("Battery Advanced" and "UPS Advanced" in the "Status" group and "Advanced" in the "Settings" group).
- An optional password, when parameters are written to the UPS device.

3 Hardware overview

Choose your customized solution - for your application.

1. Choose your power supply.
2. Choose your UPS unit.
3. Choose your energy storage.

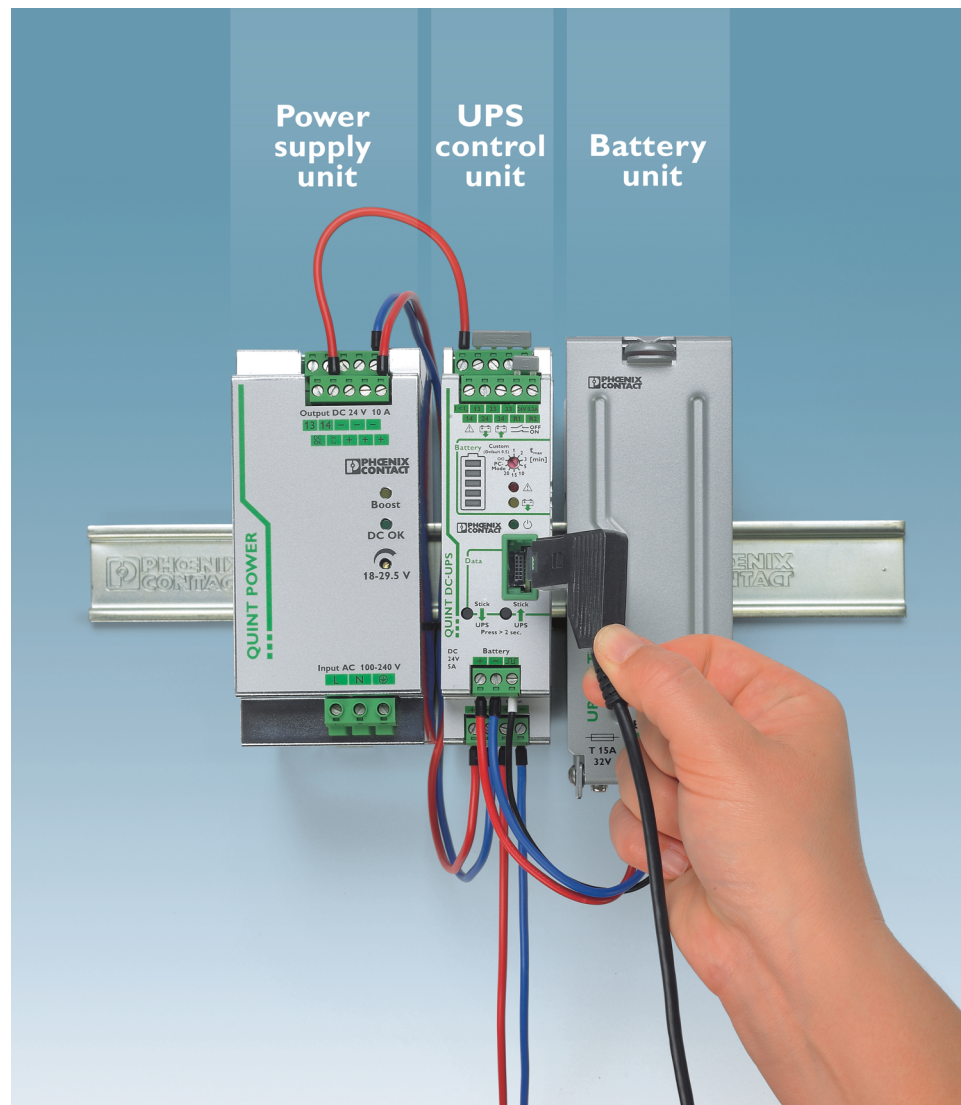

All Products are available in the e-shop: www.phoenixcontact.net/catalog

UPS-CONF

In the next two graphics and their corresponding lists you can see the location of the main parts of the QUINT DC-UPS.

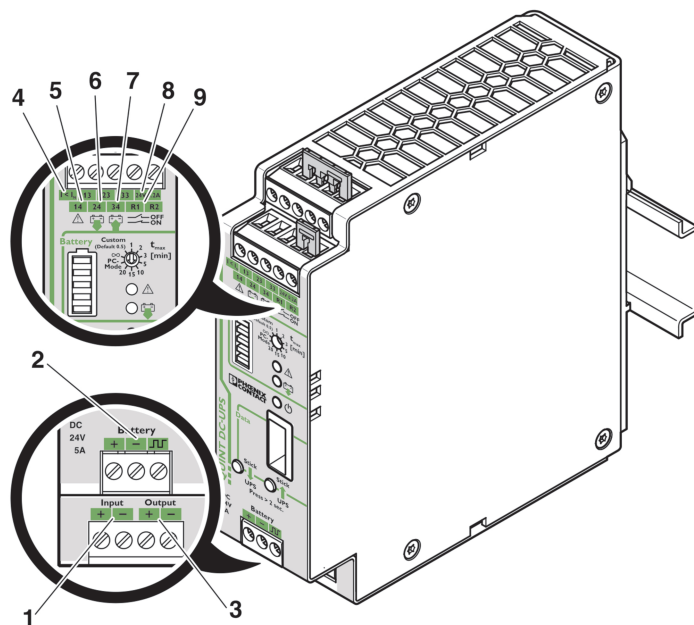

No.	Connections / Operating elements
1	DC input 18 V DC ... 30V DC
2	Power storage device connection, 24V DC (+,-, communication between UPS and power storage device)
3	DC output, 24 V DC, buffered
4	$I < I_N$, fast battery charging
5	Floating relay contact 13/14: alarm (Related parameter settings are provided in the "Reporting" view (see page 31).)
6	Floating relay contact 23/24: battery mode (Related parameter settings are provided in the "Reporting" view (see page 31).)
7	Floating relay contact 33/34 : battery charge (Related parameter settings are provided in the "Reporting" view (see page 31).)
8	24 V DC supply voltage, maximum current limit 0.2 A for the signal contacts 13, 23, 33
9	Remote control (R1, R2). (Related UPS parameter "Remote Status" (see page 27).)

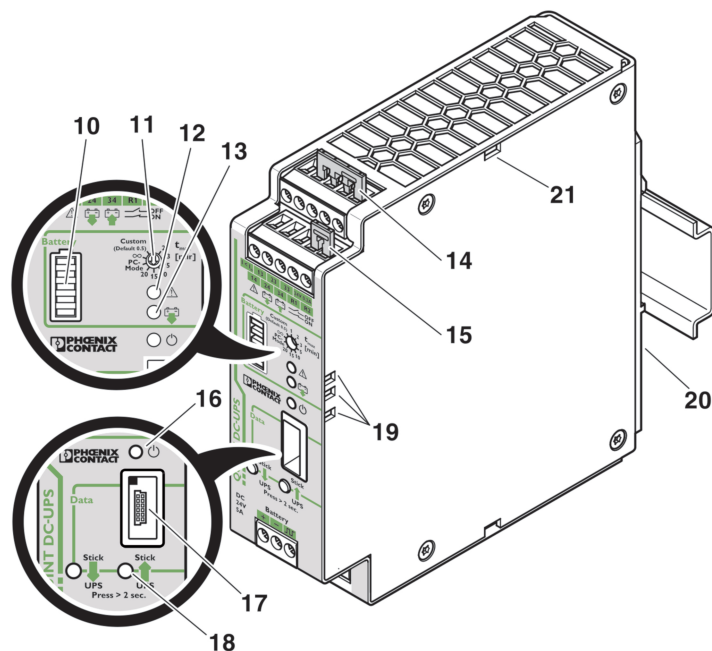

No.	Connections / Operating elements
10	Bar graph for displaying the current charging state of the power storage device
11	Buffer time setting: unlimited ∞ , 1 ... 20 mins., customized (customized default: 0.5), PC mode (refer to topic Buffer time selection (see page 12)).
12	Red LED: alarm (Corresponding indicators are displayed in the software's "Status" view (see page 20).)
13	Yellow LED: battery mode (Corresponding indicators are displayed in the software's "Status" view (see page 20).)
14	Plug-in bridge for signal contact supply voltages, pre-installed
15	Remote control plug-in bridge, pre-installed
16	Green LED: Power In OK, mains mode (Corresponding indicators are displayed in the software's "Status" view (see page 20).)
17	Data port (see page 13) for data linking to the PC or the use of a memory block
18	Button for use of the memory block
19	LED windows for flat mounting position
20	Universal snap-on foot for DIN rails
21	Accommodation for cable binders

3.1 Important safety notes



Please observe all the safety notes outlined in this topic when using UPS-CONF together with the QUINT-UPS device.

Requirements

Knowledge of the following is required:

- QUINT-UPS system
- UPS-CONF configuration software
- Safety regulations in the field of application

Qualified personnel

In the context of using the QUINT-UPS system and the UPS-CONF configuration software described in this documentation, the following operations may only be carried out by qualified personnel:

- Planning, configuration
- Installation, startup, servicing
- Maintenance, decommissioning

This documentation is therefore aimed at:

Qualified personnel who plan and design electrical equipment for machines and systems and are familiar with regulations governing safety in the workplace and accident prevention.

Within the context of the safety notes in this documentation, qualified personnel are persons who, because of their education, experience and instruction, and their knowledge of relevant standards, regulations, accident prevention regulations, and service conditions, have been authorized to carry out any required operations, and who are able to recognize and avoid any possible dangers.

4 Hardware setup

**NOTE**

Before setting up the hardware, install the software (see page 5).

Regarding the communication with the PC and the UPS operation mode, it needs only three steps to setup the hardware:

1. Set the buffer time at the buffer time potentiometer, as described in the topic Buffer time selection. (see page 12)
2. Connect the Data port either with a PC or plug in a configuration stick, as described in the topic Data port (see page 13).
3. Connect the load to be supplied by the UPS (see technical datasheet for each QUINT-UPS).

**NOTE**

For further information about the hardware installation (connecting the battery module, etc.) please refer to the QUINT DC-UPS technical datasheet.

4.1 Buffer time selection

The buffer time potentiometer at the front of the QUINT-UPS has to be switched to the desired mode with a screwdriver.

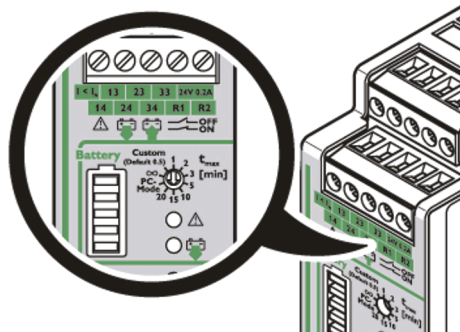

The following settings are available:

Operating mode	Description
Custom (default 0.5)	Buffer time can be set to a user-defined value; if no value is set 0.5 minutes is used, as described in the topic Custom Mode (see page 37).
1, 2, 3, 5, 10, 15, 20	Buffer time 1, 2, 3, 5, 10, 15, 20 minute(s).
PC-Mode	This mode is intended to buffer a PC and to initiate a controlled shut-down in battery mode. The buffer time depends on the "Shutdown Delay" time and on the "PC-Shutdown" time, as described in the PC-Mode (see page 38).
∞	No time limit, buffering is continued until the battery is empty (deep discharge security).



The current set buffer time is shown as "Operation mode" in the status bar (see page 17).

4.2 Data port

The Data port is located at the front of the UPS. Via this port, configuration and maintenance of the UPS is done.

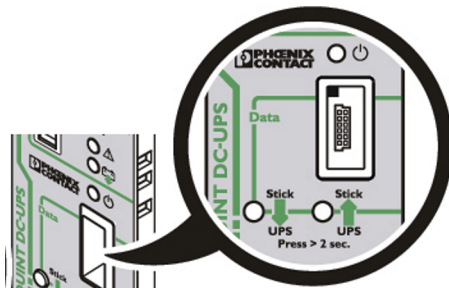

The configuration can be done in 2 different ways, depending on what is connected to the Data port:

- Connect the PC (see page 14) with the installed UPS-CONF software, if you want to configure by software.
- Plug in a memory stick which is declared as configuration stick, if you want to configure by configuration stick (see page 46).

In order to perform maintenance tasks (such as changing a battery), a service stick can be plugged into the Data port, so the UPS switches to service mode (see page 47).

4.3 Connecting the PC

A PC has to be connected to the UPS in one of the following cases:

- You want to configure or monitor the UPS by the UPS-CONF software.
- You want to display currently set QUINT-UPS parameters or modify them using UPS-CONF.
- You want to initiate a controlled PC shutdown in case of a mains failure and if battery runs low.



NOTE

First, install the software (see page 5) and then connect the PC afterwards.

To connect the PC to the QUINT-UPS, proceed as follows:

1. Connect the USB connector of the IFS-USB-DATACABLE to a free USB connector of your PC. After detecting the device, the used USB port is entered automatically in the software settings of UPS-CONF.



2. Connect the other side of the IFS-USB-DATACABLE to the Data port of the UPS:



5 Software overview

After installing the UPS-CONF software, the program starts up automatically.

As long as you do not change the related default software setting (see page 5), UPS-CONF always starts automatically after every PC reboot.

In the following sections you can get an overview about the screen areas of the UPS-CONF software and you can learn about the different status bar (see page 17) symbols and their meanings.

5.1 User interface

The screen layout consists of the following areas:

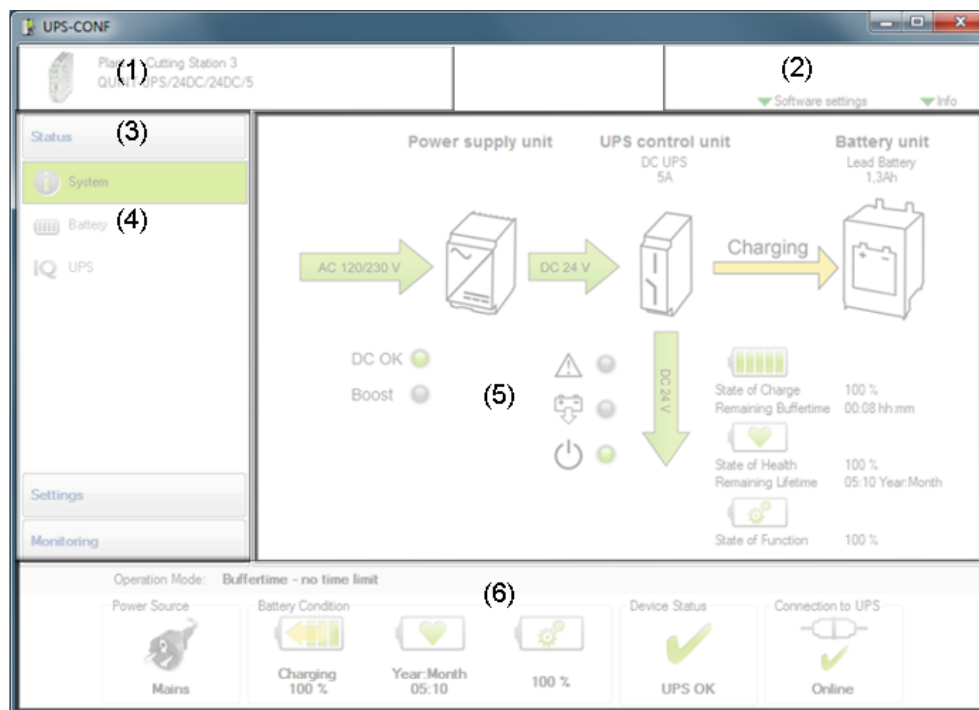

The following table explains the several areas.

UPS-CONF

Area	Description
(1)	<p>Device information: Here, the type of the connected UPS is displayed. If text has been entered for the advanced UPS parameter "Place of installation" (see page 41), it is displayed above the UPS type.</p>
(2)	<p>System menu: Software settings (see page 5): A mouse click leads to the screen, where various software settings can be made. Info: A mouse click shows the contact information of Phoenix Contact.</p>
(3)	<p>Software menu: The Software menu provides various topic buttons such as status information display, parameter settings or monitoring values. A software menu button is expanded/collapsed by simply clicking it. When a software menu button is expanded the corresponding navigation items are listed.</p>
(4)	<p>Navigation items: After clicking a navigation item the corresponding information and parameters are displayed in the action area.</p>
(5)	<p>Action area: The content of the action area depends on the currently selected navigation item. This can be, for example, information, read from the device, or a parameterization table used for configuring the connected UPS.</p>
(6)	<p>Status bar (see page 17): Displays the status of all involved components thus providing a quick system overview. The status bar is always visible, also if the navigation and action area change.</p>

5.2 Status bar

The status bar in the lower part of the screen shows information about the current system state.

When the power supply is available and the system is online and the battery is fully charged, the status bar looks like this:

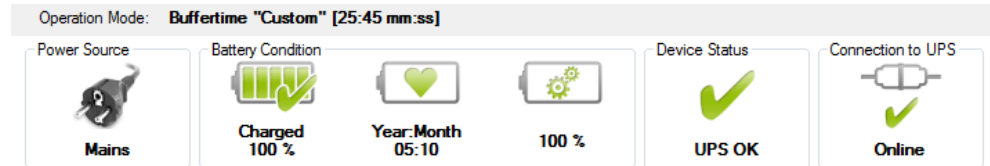

The operation mode in the upper part of the status bar shows the current setting of the buffer time potentiometer of the UPS, as described in topic Buffer time selection (see page 12).

If it looks different, e.g. Power Source status "UPS off" or no connection to UPS ("Offline"), verify the following:

- All UPS components (QUINT-UPS, battery, power supply) are functional and properly connected.
- The QUINT-UPS is supplied with 24 V DC.
- The IFS-USB-DATACABLE is properly connected between QUINT-UPS and PC.



If an alarm is detected or an existing online connection between the PC and the QUINT-UPS is interrupted, the UPS-CONF software automatically becomes the active window. The status is queried every 5 seconds.

If your system status is like described, you can



- evaluate the UPS system status by displaying the various views contained in the software menu "Status" (see page 20) and/or
- start configuring the UPS by modifying the default parameter settings in the various views of the software menu "Settings" (see page 29) and/or
- monitor your system.









In the topic Application samples (see page 52), some typical application scenarios are described.



The following tables explain the different status symbols that can be visible in the status bar:



UPS-CONF

Power Source	Symbol meaning
	The status "Mains" is shown, if the power supply is switched on and available.
	The status "Battery" is shown, if the power supply is switched off or not available. That means, the battery is discharging.
	The status "UPS off" is shown in either case: <ul style="list-style-type: none"> The UPS is off, because battery mode is finished. The set buffer time has elapsed. The power supply is available, but delivers an invalid output voltage.

Battery Condition	Symbol meaning
State of charge: 	Battery is "Fully charged".
State of charge: 	"Charging" is shown, if the battery is currently charging and not yet fully charged.
State of charge: 	The "Discharging" status is shown, if the battery is currently discharging because the system runs in battery mode. Usually, this status is shown in combination with the power source status "Battery".
State of charge: 	"Uncharged" is shown, if the battery mode is finished and the battery is empty.
State of health: 	The "State of Health" status shows the remaining lifetime of the battery. The lifetime value is shown below the symbol.

Battery Condition	Symbol meaning
State of function: 	The "State of Function" status shows the current performance of the battery. This efficiency value is measured in percent and is shown below the symbol.
	During battery charging the battery conditions "State of Charge", "State of Health" and "State of Function" are shown as "unknown".

Device Status	Symbol meaning
	The "UPS OK" status is shown during normal UPS operation, i.e., when mains is available (battery mode not active) and no other event is currently upcoming.
	"Bat.-Mode deactivated" is shown, if the bridge is removed from the terminals R1 and R2. Refer to the parameter "Remote Status" in the topic UPS (see page 27).
	The "Alarm" status is shown, when a failure or critical situation exists, for example: <ul style="list-style-type: none"> • battery almost empty • battery not detected • battery replacement required

Connection to UPS	Symbol meaning
	This status informs about the communication connection between UPS-CONF and the QUINT-UPS device. The "Online" status is shown, if the IFS-USB-DATACABLE is connected. Normally, this status is automatically entered after connecting the UPS to the PC via the IFS-USB-DATACABLE.
	"Offline" means that no communication connection is established via the IFS-USB-DATACABLE.

6 Status - Reported information

If the "Status" group is selected, the following navigation items are available:

- "System (see page 20)": overview on the current system status
- "Battery (see page 25)": status information for all connected batteries
- "Battery Advanced (see page 26)": advanced status information for all connected batteries
- "UPS (see page 27)": status information for the connected UPS
- "UPS Advanced (see page 28)": advanced status information for the connected UPS





6.1 System

If the "System" item is selected in the software menu "Status", an overview on the current system status is visible in the action area. The values shown here are read cyclically from the UPS device, as long as a communication connection to the UPS is established.

The system components and their status information are arranged on the screen as "Power supply unit" on the left hand side, "UPS control unit" in the middle and "Battery unit" on the right hand side. The tables explain the symbols corresponding to the units.











Power supply unit symbols:

Icon	Meaning of LEDs
DC OK	 Green LED on: DC output is available.  LED off: DC output is not available.
Boost	 Yellow LED on: Boost signal is ON (power supply delivers additional current for a connected load).  LED off: Boost signal is OFF.



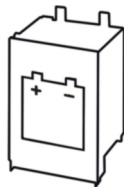

UPS control unit symbols:

Icon	Meaning of LEDs
	 Red LED on: UPS alarm due to one of the reasons: <ul style="list-style-type: none"> • battery almost empty • battery not detected • battery replacement required  LED off: No UPS alarm, power supply available, normal operation.
	 Yellow LED on: Battery mode is ON, battery is discharging because power supply failed.  LED off: Battery mode is OFF, i.e. mains available.
	 Green LED on: Mains is ON.  LED off: Mains is OFF.



Battery unit symbols:

Icon	Meaning of LEDs
	SOC (State Of Charge) – current charging state and remaining back-up time of the battery unit.
	SOH (State Of Health) – remaining life expectancy of the battery unit, provides early warning for a potential battery unit failure.
	SOF (State Of Function) – determines the current performance of the battery unit.

UPS-CONF



NOTE
While charging the battery the status is "unknown".

When the system is in normal operation (online and running), the screen looks like this:

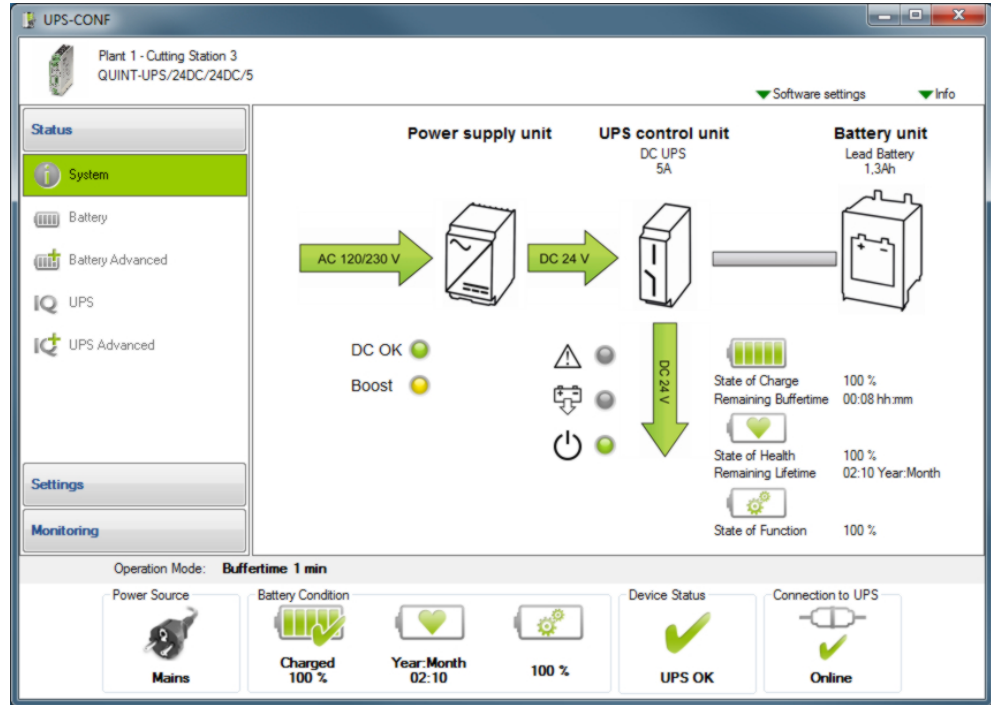

When the UPS is offline and has no connection to the PC, the screen looks like this:

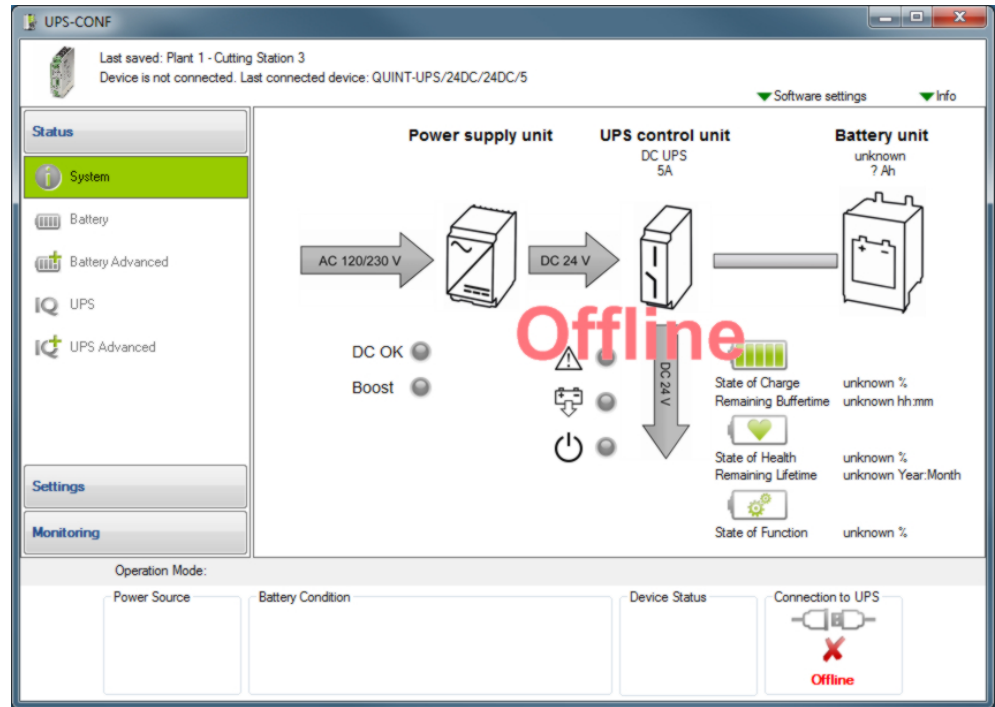

UPS-CONF

When the system status shows an alarm, the screen looks like this:

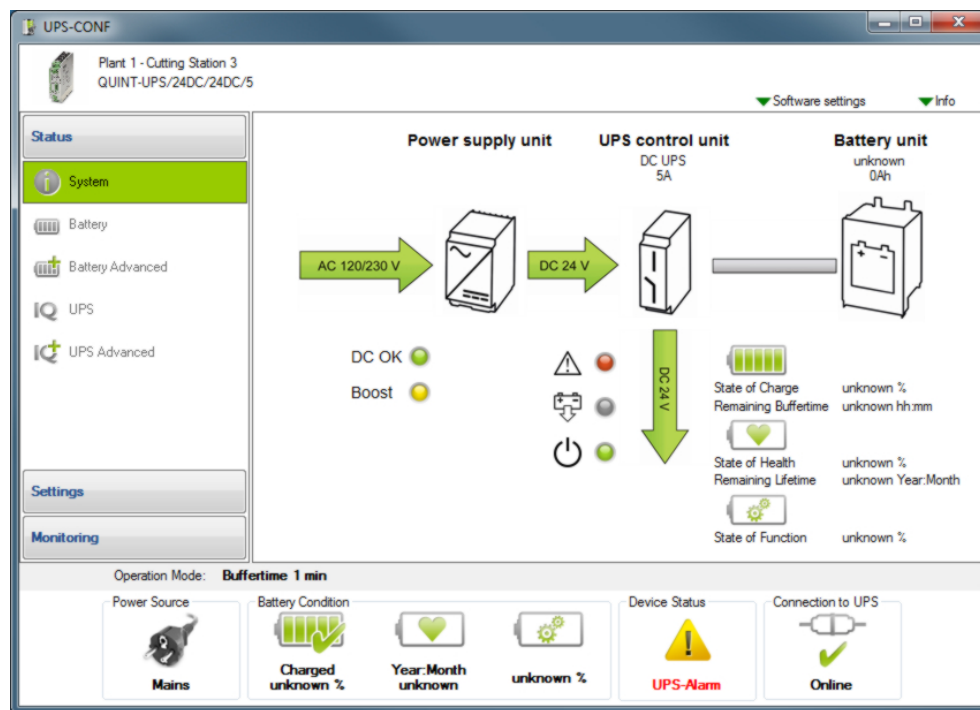

In such case refer to the topic Troubleshooting (see page 53).

6.2 Battery

If the "Battery" item is selected in the software menu "Status", status information for all connected batteries is shown in the action area.

The information is headed by "General information" for all connected batteries, such as "Number of detected battery units" or "Total nominal capacity".

Individual information for every battery follows.

If several battery units are installed, the data of the individual units can be displayed by clicking on the battery icons on top of the action area:

The status information in the action area could for instance look similar like this:



General information

Name	Value	Unit
Quantity check - Number of installed battery units?	3	
Number of detected battery units	3	
Quantity check o.k.	Yes	
Total nominal capacity	3,9	Ah
Actual battery charging current	1,37	A
Actual battery discharging current	0,00	A

Battery 1

Name	Value	Unit
Nominal battery capacity	1,3	Ah
Actual battery temperature	21	°C
Actual battery voltage	27,70	V
Serial-No.	3011355145	

Battery parameters	Meaning
	Except of some parameters explained here, the status information is self-explanatory, this is why it is not explained in detail.
Quantity check - Number of installed battery units?	This value can be set to the amount of batteries, that were built in.
Number of detected battery units	Number of batteries detected by the QUINT-UPS.

Battery parameters	Meaning
Quantity check o.k.	Shows "Yes", if the number of installed battery units complies with the number of detected batteries. Otherwise "No" is displayed.

6.3 Battery Advanced



This navigation item is only available if the "Enable advanced views" checkbox is marked in the software settings (see page 5).

If the "Battery Advanced" item is selected in the software menu "Status", advanced status information for all connected batteries is shown in the action area.

In normal operation it looks something like this:

Name	Value	Unit
Actual state of charge	100	%
Remaining backup time	00:08	hh:mm
Remaining battery life time	01:03	Year:Month
Actual battery performance	100	%
Actual battery voltage	27,57	V
Actual battery temperature (Average of all units)	26	°C

6.4 UPS

If the "UPS" item is selected in the software menu "Status", status information for the connected UPS is shown in the action area.

In normal operation it looks like this:

Name	Value	Unit
Actual Alarm	No Alarm	
Last Alarm	No Alarm	
Remote Status	UPS ready	
UPS in battery operation (Battery-Mode)	No	
Selected operation mode	Buffertime - no time limit	
Battery is charging (Battery-Charge)	No	

Parameter	Meaning
	Except of some parameters explained here, the status information is self-explanatory, this is why it is not explained in detail.
Remote Status	<p>Remote control (contact R1, R2) The module can be switched on and off via a signal to contacts R1 / R2. Shutdown can take place in mains mode or while battery mode is active.</p> <p>Remote shutdown is deactivated UPS in function (delivery state) – The "R1" and "R2" terminal points are short circuited (delivery with plug-in bridge) OR 24 V DC is present at terminal point "R2". – In the event of a voltage supply failure, the UPS switches over to battery mode.</p> <p>Remote shutdown is activated – The "R1" and "R2" terminal points are not short circuited AND 0 V is present at terminal point "R2". – In the event of a voltage supply failure, the UPS does not switch over to battery mode and the device shuts down.</p>
Selected operation mode	Shows the operation mode that is set via the buffer time potentiometer, as described in topic Buffer time selection (see page 12).

6.5 UPS Advanced



This navigation item is only available if the "Enable advanced views" checkbox is marked in the software settings (see page 5).

If the "UPS Advanced" item is selected in the software menu "Status", advanced status information for the connected UPS is shown in the action area.



The status information is self-explanatory, this is why it is not explained in detail here.

In normal operation it looks something like this:

Name	Value	Unit
Device type	QUINT-UPS/24DC/24DC/5	
Actual input voltage	23,91	V
Actual output voltage	23,66	V
Actual Device Temperature	30	°C
Shutdown event started	No	
UPS serial number	3012001033	
Device firmware	0x00000110	

7 Settings - Defining UPS device parameters

The navigation items contained in the "Settings" group allow access to the various UPS device parameters.

Parameter values can be entered in UPS-CONF and written to the device (see page 29) with only one click of the mouse.

If the software menu "Settings" is selected, the following navigation items are available:

- Reporting (see page 31): Trigger thresholds, switching outputs for UPS alarm, battery mode and battery charging as well as Email settings
- Time Setting (see page 36): Buffer times, (delay) times and programs to execute for PC shutdown
- Service (see page 39): Service mode activation and rights granting, declaration of service stick and configuration stick
- Advanced (see page 41): Battery charging values, wire sizes, thresholds, signaling times and others

How to write parameters

In each of the navigation items, different settings can be made in the action area in order to write it to the UPS.

Beneath settings, that can be made by checking a checkbox or by entering data into an input box, also numerical or textual values contained in the parameter tables can be changed.

In these parameter tables, changeable parameter values have a white background color. Read-only values, i.e. the ones that are read from the device for monitoring purposes, are shown on a gray background.

To enter a new value for a parameter and write it to the UPS, proceed as follows:

1. Double-click the line, where the parameter text is located or click the "Write..." button in the lower right corner.
An input box opens showing the currently set value.
2. Enter a value into the input box. Make sure that the chosen value is within the allowed value range and is suitable for your UPS system!
3. Click the "Write to device" button.
4. Verify that the new value is now displayed in the parameter table, i.e., has been accepted by the device.

Sample:

Select the "Reporting" navigation item in the "Settings" group and click the "Trigger Thresholds" tab in the action area.

In this tab, you can set a trigger value, at which battery charging level a "battery low" warning should be generated (first entry in the tab Trigger Thresholds (see page 31)). The value is entered as percentage, see below. By default, the trigger is "disabled", i.e. no warning is reported.

Name	Value	Unit
Warning - Battery Low - State of Charge	disabled	%
Warning - Battery Low - Remaining backup time	disabled	hh:mm
Warning - Battery Low - Battery voltage	disabled	V
Warning - Battery End of Lifetime - Remaining life time	disabled	Year:Month
Alarm - Battery Low - State of Charge	90	%
Alarm - Battery Low - Remaining backup time	disabled	hh:mm
Alarm - Battery Low - Battery voltage	20,4	V
Alarm - Battery End of Lifetime - Remaining life time	00:05	Year:Month

Set the trigger to 20% as follows:

1. Double-click the marked line, as shown in the figure above or left-click the line and then press the "Write..." button in the lower right corner.

The following dialog appears:

Write parameter

Warning - Battery Low - State of Charge / [%]:

disabled

Min.: 1 % / Max.: 100 % / Default: 0 %
Option: 0 = disabled

Write to device Cancel

Below the text field you can see the allowed input range.

2. Enter 20 in the input box and click the "Write to device" button.
3. Verify that the new value is shown in the table.

7.1 Reporting

If the "Reporting" item is selected in the software menu "Settings", the tabs "Trigger Thresholds", "Switching outputs", "Email 1" and "Email 2" are visible in the action area.

Trigger Thresholds

On the "Trigger Thresholds" tab you can define, whether warnings or alarms shall be reported by the UPS and define the threshold values which must be exceeded in order to trigger a message.

UPS-CONF
Plant 1 - Cutting Station 3
QUINT-UPS/24DC/24DC/5

▼ Software settings ▼ Info

Trigger Thresholds | Switching outputs | Email 1 | Email 2

Name	Value	Unit
Warning - Battery Low - State of Charge	disabled	%
Warning - Battery Low - Remaining backup time	disabled	hh:mm
Warning - Battery Low - Battery voltage	disabled	V
Warning - Battery End of Lifetime - Remaining life time	disabled	Year:Month
Alarm - Battery Low - State of Charge	10	%
Alarm - Battery Low - Remaining backup time	disabled	hh:mm
Alarm - Battery Low - Battery voltage	20,4	V
Alarm - Battery End of Lifetime - Remaining life time	00:05	Year:Month

Set factory defaults Write ...

Operation Mode: **Buffertime - no time limit**

Power Source: Mains
Battery Condition: Charged 100 %
Year:Month: 05:10
100 %
Device Status: UPS OK
Connection to UPS: Online

For each of the following conditions, both a warning and an alarm threshold value can be defined:

- Battery is low and the state of charge falls below a certain percentage number.
- Battery is low and the remaining backup time falls below a defined time.
- Battery is low and the battery voltage falls below a certain voltage.
- Battery is at it's end of lifetime and the remaining life time falls below a defined time.

If a warning or alarm is reported, you can define that a switching output must be triggered. For some of the warnings or alarms an Email to be sent can also be defined.

UPS-CONF

A reported alarm is additionally signaled by the LED at the front of the UPS device as well as in the status bar of the UPS-CONF software.

By means of warnings and alarms you can implement a two-level detection system:

1. Report a warning, when the first threshold value is exceeded.
Example: battery lifetime is still one year.
2. Report an alarm, when the second threshold value is exceeded.
Example: remaining lifetime of the battery is only some few months or weeks. Now an Email is additionally sent to the responsible person to ensure that a new battery is ordered in time.

Switching outputs

On the "Switching outputs" tab you can define a QUINT-UPS device output signal to be switched, when a certain trigger occurs. With such an output signal you can, for example, control a buzzer, that sounds, if the battery is low or the shutdown has been initiated.

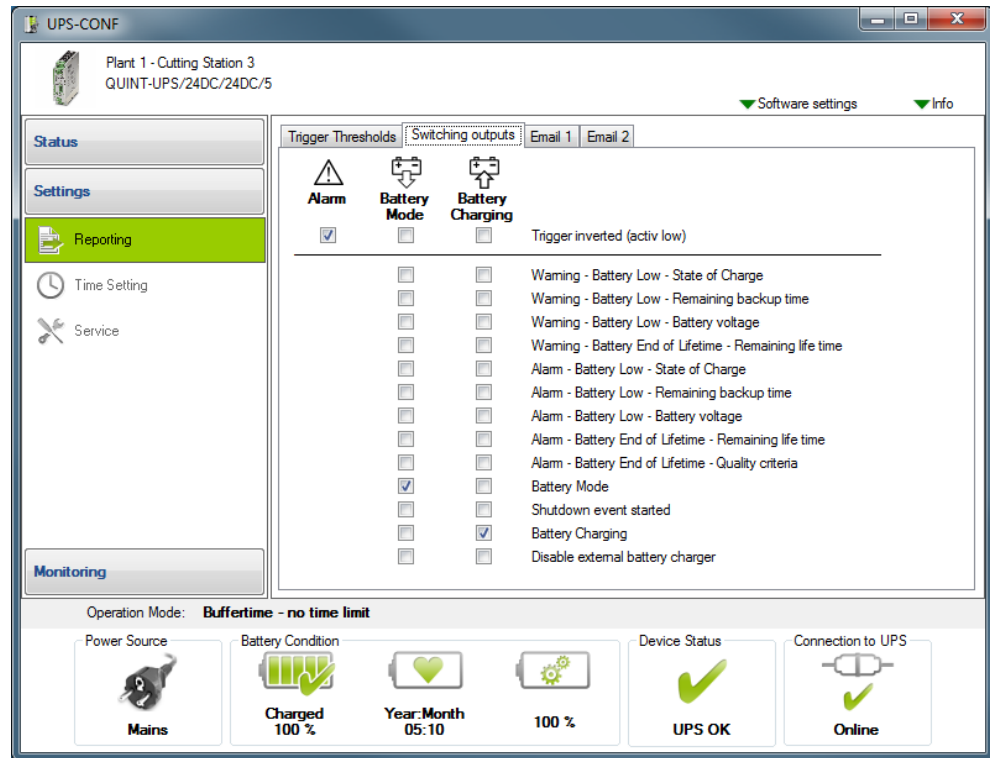

Three different outputs are available to be switched:

- "Alarm",
- "Battery Mode"
- "Battery Charging"

All switching outputs can be triggered inverted, i.e., active low.

The "Battery Mode" and "Battery Charging" output signals can be switched with the following triggers:

- The same triggers as described in section "Trigger Thresholds" for warning and/or alarm, e.g. triggers that are released by an exceeded or underrun threshold.
- The quality criteria is no more fulfilled. The IQ-Technology of the QUINT-UPS-IQ is able to calculate it's own save remaining lifetime for the battery. Based on this calculation, the quality criteria is evaluated as met or not.
- The system switches to battery mode.

UPS-CONF

- A shutdown event started.
- The battery switches to the "Battery Charging" status.
- For the "Disable external battery charger" trigger, see technical datasheet for the QUINT-UPS.

For "Alarm" switching output, no further options can be defined.

Email 1 / Email 2

On the "Email 1" and "Email 2" tabs you can define two separate Email addresses, to which Emails can be sent if certain events occur. To access the input fields, mark the "enable" checkbox in the upper part of the screen.

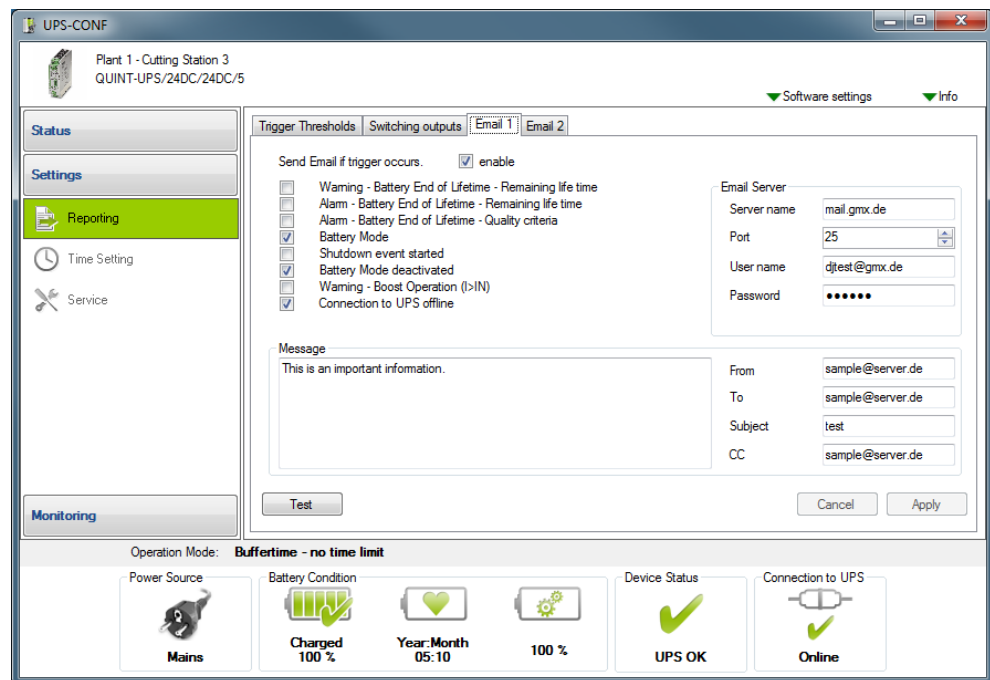

The available triggers to initiate Emails to be sent are:

- A warning occurs as battery is at it's end of lifetime and the remaining life time falls below a defined time.
- An alarm occurs as battery is at it's end of lifetime and the remaining life time falls below a defined time.
- An alarm occurs as the quality criteria is no more met.
- The battery switches to battery mode.
- A shutdown event started.
- The battery switches to "Battery Charging" status (battery mode deactivated).

- A warning occurs because boost operation was activated. The power supply now delivers BOOST current, which is up to 1.5 times the nominal current of the power supply (only available with QUINT POWER).
- The connection to the UPS was interrupted ("Offline" status).

In the Email Server area, you have to enter:

- "Server name" for the server managing your outgoing mail. Ask your administrator for details.
- "Port" for outgoing Emails is usually 25. The predefined port 25, however, can be changed.
- "User name" and "Password" of your Email account. In some accounts the "User name" is the Email address.

The Message area contains:

- Messagebox: A short explanation of the trigger, that caused the Email, is sent as default message. You can enter additional text, that will be appended to the default text.
- "From" textbox: Any Email address can be entered here.
- "To" textbox: A valid Email address has to be entered here, where the Email is sent to; it must be an Email address, that exists in the Email server's configuration.
- "Subject" textbox: the title of your Email is user-defined; it is only used with the Email "Test" button. When the Email is successfully sent, click the "Apply" button.
- "CC" textbox: you can enter an Email address, where a copy is sent to.

You can test your settings by clicking on the "Test" button.

Sample Email:

A sample Email would look like this:

Email part	Content of Email part	Explanation
Subject	[UPS CONF: Parameters change notification]	
Message	*** UPS Status Mail ***	Header of the status mail message
	Hall 125	Place of installation, refer to the topic Advanced (see page 41)
	QUINT-UPS/24DC/24DC/5	Type of connected UPS, refer to the device information area in the User interface (see page 15)
	Trigger: Battery Mode Trigger	Kind of active trigger
	Threshold: -	Threshold (if applicable)
	This is an important information.	User defined text from the message textbox

7.2 Time Setting

If the "Time setting" navigation item is selected in the "Settings" group, the action area provides various settings for two different UPS operating modes:

- The upper part (above the separation line) specifies the "Custom" mode.

Buffertime of Switch Setting „Custom“: mm:ss Max.: 1 h

- In the lower part (below the separation line), four different parameter categories can be set concerning the PC-Mode.

1 State of Charge based Shutdown Delay: enable
 Shutdown Delay: h:mm Max.: 2 h

2 Program Startup if „Shutdown Delay“ expired: enable
 Max. Program Runtime: mm:ss Max.: 5 min
 Program path:
 Program arguments:

3 PC-Shutdown: mm:ss Max.: 5 min
 Countdown (15 seconds) till PC-Shutdown: enable

4 PC-Restart Delay: seconds Max.: 60 seconds

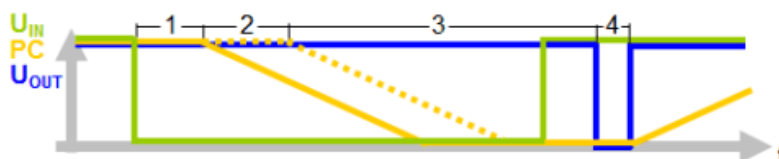

Custom mode

**NOTE**

These settings only apply if the UPS runs in Custom mode. To set this mode, the buffer time potentiometer located at the device front must be set to "Custom" (refer to topic buffer time selection (see page 12)).

In Custom mode the buffer time for the battery can be set to a maximum of 1 hour (30 seconds default).

When the power supply was interrupted the load will loose it's power after the user-defined buffer time has elapsed. The battery will buffer exactly the set buffer time. If no user-defined time is entered, the buffer time selected by the potentiometer is used.

The set time is displayed in the "Operation Mode" of the status bar. An example with 25 minutes and 45 seconds set, shows the following status bar and operation mode:

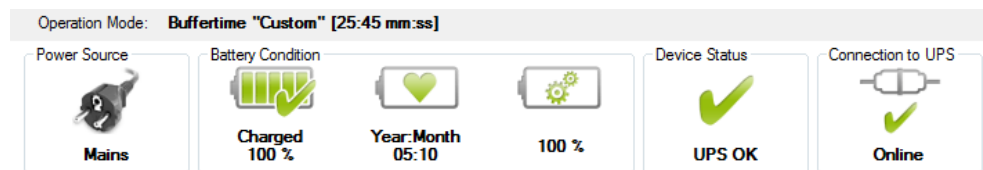

PC-Mode



NOTE

These settings only apply if the UPS runs in PC-Mode. To set this mode, the buffer time potentiometer located at the device front must be set to "PC-Mode" (refer to topic buffer time selection (see page 12).

When the PC-Mode is set, the status bar shows the operation mode "PC-Mode", as shown in the following screenshot:

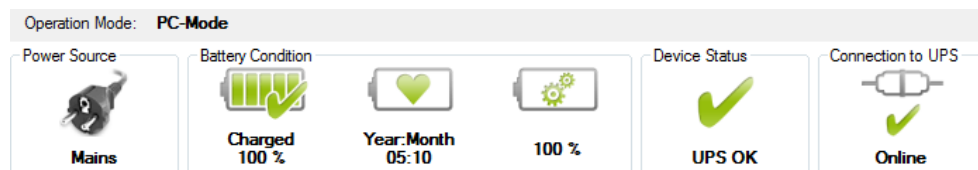

In the "PC Mode" setting on the UPS potentiometer, the UPS functionality follows a chronological sequence that can be parameterized via software, and is thus individually customized to the respective application.

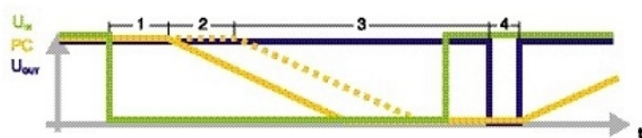

Parameter	Meaning / Possible settings
1 Shutdown delay	Delay time is calculated automatically from the current remaining battery life minus the time required by the PC to shutdown. Alternatively, a fixed delay time may be chosen.
2 Program startup	After the delay time has expired it is possible to start a program. Example: a software starts that gradually backs up system data. <div style="border: 1px solid black; padding: 5px; display: inline-block;"> You can test your settings by clicking on the "Test" button. </div>
3 PC shutdown	The time required by the PC/IPC to shut down is set here.
4 PC restart delay	Only if the PC/IPC is shut down, and the mains has returned in the meantime, the output voltage will be interrupted for the reset time. The PC/IPC is then automatically restarted.

7.3 Service

If the "Service" item is selected in the software menu "Settings", all parameters of switching the UPS to service mode are accessible in the action area.

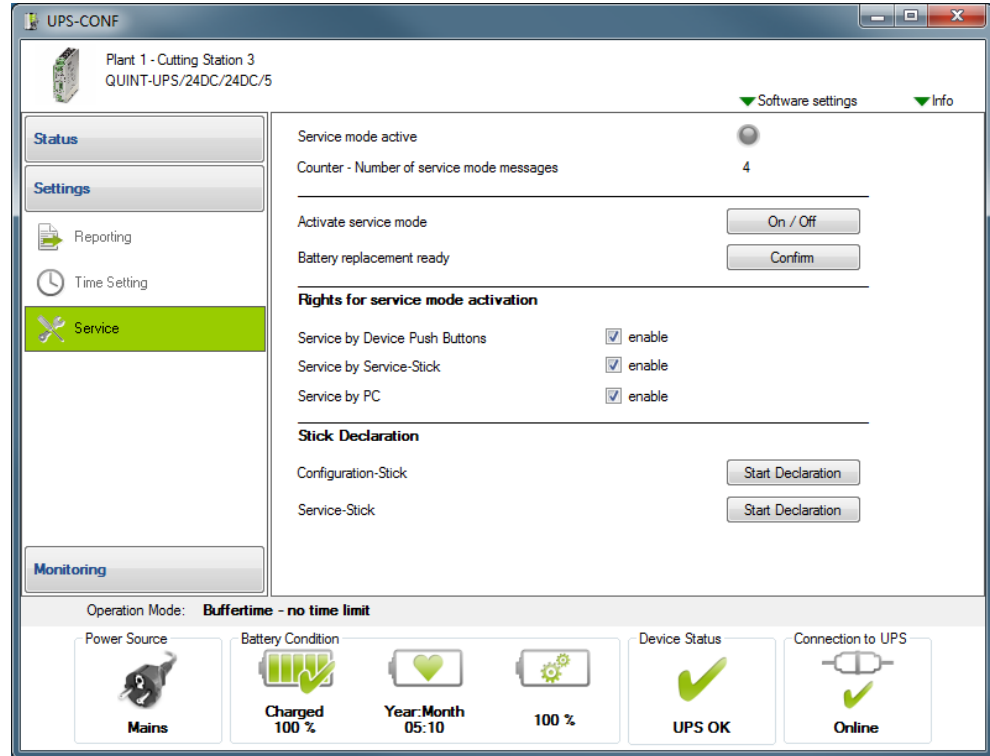

Here, you can:

- Operate the UPS in service mode (see page 47).
- Grant or deny rights for the service mode activation (see section below).
- Declare memory sticks as either configuration sticks or service sticks, as described in the topic Stick usage (see page 45).

Rights for service mode activation

The rights for all possible methods to activate or terminate the service mode can be defined in the "Rights for service mode activation" part of the "Service" navigation item's action area.

Possible activation methods are:

- Pressing both push buttons ("Stick -> UPS" and "UPS -> Stick") on the device front simultaneously.
- Plugging a service stick into the Data port of the UPS device.

UPS-CONF

- Clicking the service mode activation button in the "Service" navigation item's action area in UPS-CONF.

When allowing a service stick for activating the service mode and disabling the use of the push buttons at the same time, the stick can be considered as a kind of hardware key: Only authorized persons who possess a service stick are allowed to switch the device to service mode. For that purpose, a memory stick must be declared accordingly as described in Stick usage (see page 45).



For further information please refer to the "Service stick usage - service mode (see page 47)".

7.4 Advanced



This navigation item is only available if the "Enable advanced views" checkbox is marked in the Software Settings (see page 5).

The "Advanced" navigation item within the "Settings" group allows to set more specific parameters. These are in detail:

Name of parameter:	Sample value:	Unit:	Explanation:
Place of installation (user defined)	Hall 125	(none)	The text entered here is displayed in the device information area of the User interface (see page 15).
Initial charging current	1.36	A	The battery is charged with this current, when the power supply is available.
Absorption charging end voltage	28.00	V	An equalizing charge, that increases charging voltage to a higher value than the nominal capacity for a short period. This prevents battery stratification and reduces sulfation. When the battery is fully loaded, this voltage is tolerated as a maximum, before the voltage level gets a stable end value.
Float charging end voltage	27.60	V	The charger adjusts the end voltage based upon battery temperature. During high temperature periods, the actual battery voltage will be reduced and during low temperature periods it will be increased.
Temperature compensation	42	mV/K	High ambient temperatures have a negative impact on the service life of the battery. Therefore, the charging voltage should be lower with higher ambient temperatures. The adjustable values relate to one battery cell each.
Wire distance to the battery unit	300	mm	The maximal wire length from the UPS control unit to the battery unit.
Wire cross section to the battery unit	6.0	qmm	The wire cross section from the UPS control unit to the battery unit.

UPS-CONF

Name of parameter:	Sample value:	Unit:	Explanation:
Fast battery charging	On	(none)	Boost mode is allowed or not.
Dynamic backup threshold	Off	(none)	This parameter can be defined additionally to the overvoltage and undervoltage related parameters, see below. If set to On the voltage increase or decrease within a certain time period is watched (dynamically). The UPS switches to battery mode, if the relative increase/decrease is too much. In contrast the overvoltage and undervoltage parameters have static values. They can become active regardless the dynamic backup threshold did not trigger, because the voltage was alright.
Undervoltage backup threshold	19.00	V	When the DC voltage falls under this threshold (undervoltage), the system switches to battery mode.
Overvoltage backup threshold	30.00	V	When the DC voltage exceeds this threshold (overvoltage), the system switches to battery mode.
Return to mains time	3	seconds	After this time the system returns to mains, when it is in battery mode and the power supply is available again.
Discharging end voltage	19.20	V	The battery voltage may not sink below this voltage value, otherwise it would be deeply discharged and become defective.
Signaling time after battery low cutoff	00:10	hh:mm	When the battery low status has arrived, the UPS cuts off and the status of the power source firstly switches to "UPS off (see page 27)". After the time set here no more power or battery status is displayed, but only the Connection to UPS (see page 17) is offline.
Signaling time after time cutoff	00:10	hh:mm	When the buffer time has elapsed, the UPS cuts off and the status of the power source firstly switches to "UPS off (see page 27)". After the time set here no more power or battery status is displayed, but only the Connection to UPS (see page 17) is offline.

Settings - Defining UPS device parameters

Name of parameter:	Sample value:	Unit:	Explanation:
Battery type (imported item)	"No value assigned"	(none)	The type of battery delivered by the manufacturer. This value is read by the UPS-CONF software.
Nominal capacity (imported item)	"No value assigned"	Ah	The nominal capacity of the battery delivered by the manufacturer. This value is read by the UPS-CONF software.



You can restore the default settings anytime by clicking the "Set factory defaults" button.



You can import / export the list in a .csv file by clicking the button "Import " or "Export".

8 Monitoring - Statistics and logging

If the "Monitoring" group is selected, the navigation items "Statistic (user defined)", "Statistic (system defined)" and "Logging" are available.

The items inform about counted and time measured statistic values and show logged information.

Statistic (user defined)

The "Statistic (user defined)" navigation item shows counter values which start at a user-defined value. If, for example, batteries have been replaced, you can set the values manually to "0" in order to start a new logging period. The following values are displayed and can be reset:

- Number of battery modes: How often did the UPS already change to battery mode?
- Total time of battery mode: How long altogether did the UPS stay in battery mode?
- Number of operation startups: How often was the UPS started?
- Total operation time: How long altogether did the UPS run?

Statistic (device defined)

The "Statistic (system defined)" navigation item shows counter values which always start from the value "0" with the initial device installation. Beneath the same values as shown in the "Statistic (user defined)" navigation item, additional values are displayed:

- Runtime of the current battery operation: How long does the current battery operation (if relevant) already last?
- Number of battery low cutoffs: How often was the battery completely discharged?
- Number of all messages: How many warnings and alarms were signaled altogether?
- Number of remaining lifetime messages: How often was a remaining lifetime signaled?
- Number of quality criteria messages: How often was signaled, that the quality criteria is no more met?
- Number of battery presence messages: How often was a battery unit not detected, e.g. no fuse plugged or circuit broken?

Logging

The logging is done by the software itself.

The "Logging" navigation item lists events like "Offline", "Online" or "UPS in battery mode" with date and time stamp. The event colors differ between green and red depending on the type of event. They are chronologically sorted, the latest uppermost.



You can delete the list by clicking the button "Delete history".
You can export the list in a .csv file by clicking the button "Export".

9 Stick usage

At the Data port of the UPS device, a memory stick can be connected (see image below). After plugging in, the UPS either acts as configuration stick or as service stick, depending on how the respective stick has been declared before in the "Service" screen of the UPS-CONF software.



A configuration stick is used to copy parameterization data from/to the UPS device, as described in the topic Configuration stick usage (see page 46).

A service stick can be used to switch the device to service mode (see page 47) in order to perform maintenance tasks.

To declare a memory stick proceed as follows:

**NOTE**

When declaring a stick, its current content is deleted, i.e. already stored configuration data are lost.

1. Open the software menu "Settings".
2. Click the "Service" navigation item.
3. In the "Stick declaration" area of the action area, click the appropriate "Start declaration" button.

After this declaration, the UPS device automatically formats the stick after plugging it into the Data port the next time and then acts accordingly.

9.1 Configuration stick usage

A configuration stick stores UPS configurations, i.e. complete parameter sets. Configurations can be copied from the UPS to the stick and vice versa. This way, the stick can be used to transfer configurations from one UPS to another.

**NOTE**

The configuration stick cannot be used, while the UPS runs in battery mode. The power supply must be available.

The usage of configuration sticks is explained by the following steps:

1. Make sure that the used memory stick is already declared as configuration stick as described in the topic Stick usage (see page 45).
2. To transfer parameters between the stick and the UPS, execute one of the following steps:
 - To copy parameters from the stick to the QUINT-UPS push the "Stick -> UPS" button for more than 2 seconds.
 - To copy parameters from the QUINT-UPS to the stick push the "UPS -> Stick" button for more than 2 seconds.
3. Connect the configuration stick to the Data port of the UPS under consideration of the plug direction.
The parameter transfer is started automatically and the progress is signalled by the LEDs:
 - While data is transferred they flash red - yellow - green.
 - A successful transfer completion is signalled by a permanent green LED.
 - A faulty transfer completion is signalled by a permanent red LED.
4. Remove the stick from the Data port.
5. After copying a parameter set from an UPS to the stick you can "clone" this configuration by plugging this stick into another UPS and copying the stored data from the stick into this UPS.

9.2 Service stick usage - service mode

The service mode is used, when installation and maintenance work has to be achieved, such as a battery has to be replaced.

There are several possibilities to switch the UPS to service mode.



The corresponding activation rights have to be granted for service mode activation and deactivation, as described in the topic Rights for service mode activation (see page 39).

Service mode activation



The service mode cannot be activated, while the QUINT-UPS runs in battery mode. The power supply must be available.

Depending on the granted activation rights, the service mode can be activated in three different ways:

- By holding down both push buttons on the QUINT-UPS named "Stick -> UPS" and "UPS -> Stick" for at least 6 seconds.

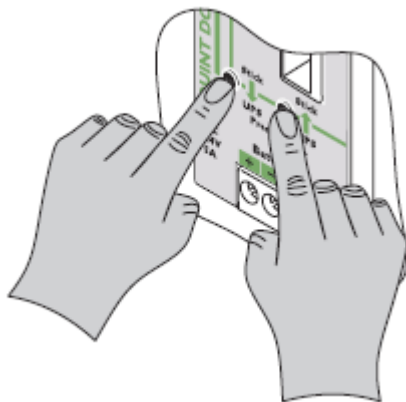

- By connecting a service stick (see page 45) to the Data port (see page 13) of the UPS.
- By using the UPS-CONF software as follows:
In the "Settings" group, select the "Service" item, and click the "On / Off" button near the "Activate service mode" text.

While the service mode is active

- the alarm status is activated,

UPS-CONF

- the charging current is interrupted,
- the status LED "Service mode active" in the UPS-CONF software ("Settings" group / "Service" item) is green.

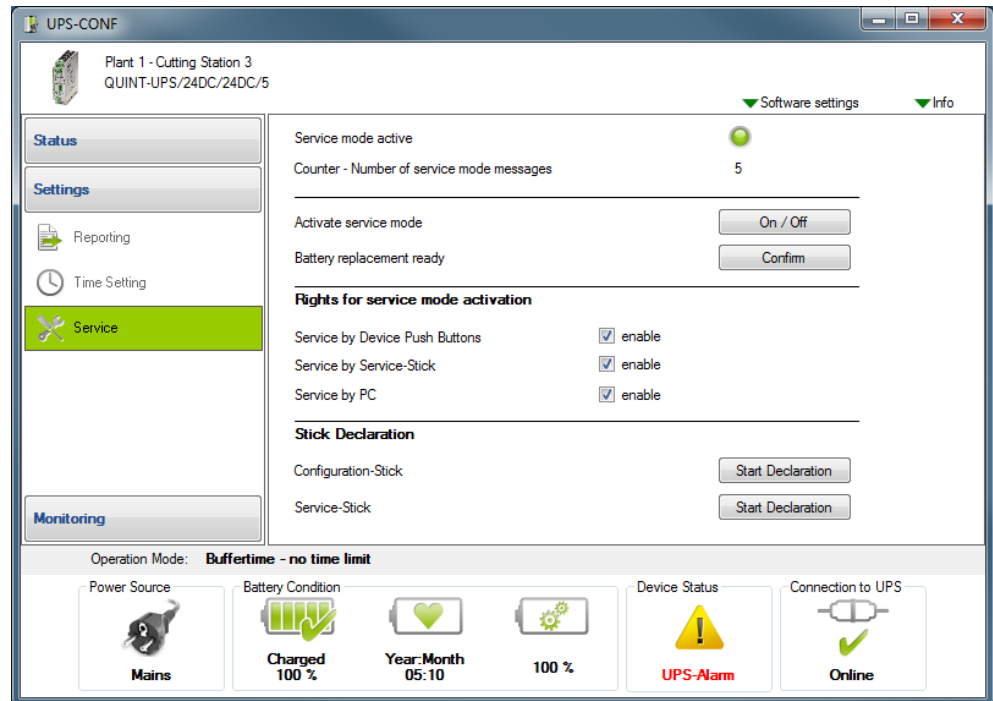

Service mode deactivation

The service mode can be deactivated in different ways:

- By holding down both push buttons on the QUINT-UPS named "Stick -> UPS" and "UPS -> Stick" for at least 6 seconds.

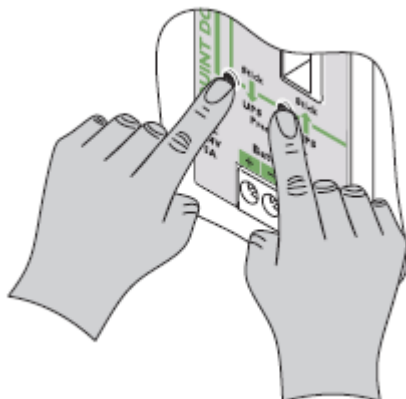

- By removing the service stick from the Data port of the UPS.
- By using the UPS-CONF software as follows:
In the "Settings" group, select the "Service" item, and click the "On / Off" button near the "Activate service mode" text.

After the service mode is deactivated, the status LED "Service mode active" in the UPS-CONF software ("Settings" / "Status") switches back from green to gray.

Service mode operation

To operate the QUINT-UPS in the service mode in order to replace a battery for example, execute the steps described below.



DANGER

Before activating the service mode read and obey carefully the safety instructions in the topic Important safety notes (see page 10).



DANGER

Watch polarity when connecting cables!

1. Activate the service mode by one of the ways described above.
2. Replace the battery as follows:
 - i. Open battery housing.
 - ii. Remove fuses.

UPS-CONF

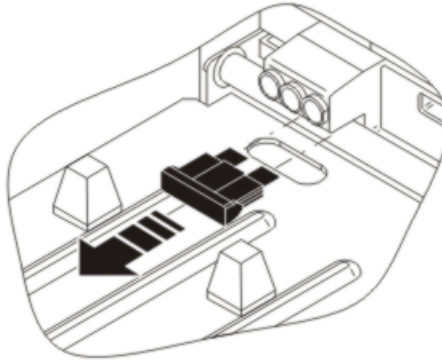

- iii. Remove cabling.
- iv. Change battery.
- v. Connect cabling.
- vi. Insert fuses.

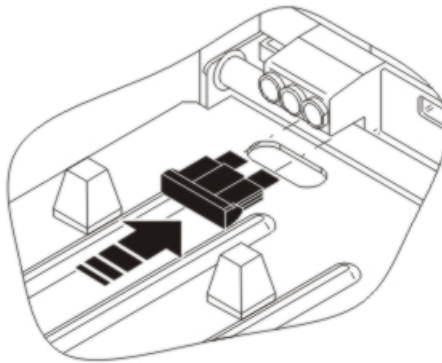

- vii. Close battery housing.
3. As soon as the work is finished, the parameters of the new battery have to be read into the UPS, so it's status information is available. To introduce this battery registration, do one of the following actions:
 - Push one of the push buttons on the QUINT-UPS named "Stick -> UPS" or "UPS -> Stick" and hold it down for more than 6 seconds.

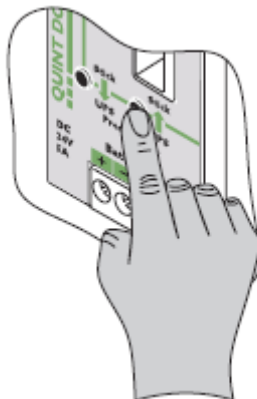

or

- In the "Settings" group of the UPS-CONF software select the "Service" item, locate the text "Battery replacement ready" and click the "Confirm" button near the text.



The bar graph at the QUINT-UPS flashes, the alarm status is still active.



NOTE

If the service mode has been deactivated by removing the service stick from the Data port before the battery replacement has been confirmed, it can be confirmed by the UPS-CONF software. A popup window will remind the user to confirm the battery replacement.

4. Deactivate the service mode as described above.

10 Application samples



For further information, please take a look at the Software Tutorials or the Quick Start Poster on www.phoenixcontact.net/catalog. You will find the data if you link to UPS-CONF or QUINT-UPS.

10.1 Functional test

One of the main functions of the QUINT-UPS is to supply the load, when the mains fails. To test, if the UPS buffers the load, follow these steps:

1. Switch off the power supply of the QUINT-UPS.
2. Check if the QUINT-UPS buffers the load as long as set with the buffer time potentiometer, refer to Buffer time selection (see page 12).

10.2 PC-Mode: PC shutdown and restart

The IQ technology of the QUINT-UPS is able to control the power supply for a PC. For that purpose the PC with the UPS-CONF software installed has to be connected to the UPS and the PC-Mode activated. The PC-Mode enables the automatic PC shutdown and restart functionality.

To test the PC shutdown and restart functionality in the PC-Mode, proceed as follows:

1. Switch the buffer time potentiometer to "PC-Mode", as described in the topic Buffer time selection (see page 12).
2. Connect the UPS device to a USB port of the PC where UPS-CONF is installed (refer to topic Hardware setup (see page 11)).
3. Open the software menu "Settings" and click "Time Settings".
4. Set the parameters for the four different parameter categories, as described in the topic PC-Mode (see page 38).
5. Check if the PC shuts down and restarts corresponding to the set parameters. If a program execution has been set, verify that it is executed.

11 Troubleshooting

If your system does not work properly for any reason, approach the problem in the following manner:

1. Check the system status:
 - If the UPS-CONF software is installed, check the status bar (see page 17) and take a look at the system status.
 - If the UPS-CONF software is not installed, take a look at the front side of the UPS and check the LEDs (see page 20).
2. Proceed with the section Unexpected status symbols (see page 54) to find out, what is wrong.













The section Unexpected status symbols (see page 54) will lead you closer to the solution of the problem. If there are specific solutions for a single problem, you will be lead to the section, that describes the problem solving.

11.1 Unexpected status symbols

The meaning of status symbols showing an unexpected status is explained in the following topic.

The first table lists the symbols for the system status, that you can find in the action area and the second table lists the symbols from the status bar.

System status Symbol	Current situation and possible reason	Possible correction
 Gray: Mains OFF	There is no current available. Probably the Mains is switched OFF.	<ul style="list-style-type: none"> • Switch the Mains ON. • Take care that the power supply is available again.
 DC Gray: DC output not available	The power supply unit cannot deliver DC. Either the power supply is not available or the Mains switch is set to OFF.	<ul style="list-style-type: none"> • Switch the Mains ON. • Take care that the power supply is available again.
 Yellow: Battery mode	No current is available, thus the load gets it's power supply from the battery.	<ul style="list-style-type: none"> • Switch the Mains ON. • Take care that the power supply is available again.
 Red: UPS alarm	There may be different reasons: <ul style="list-style-type: none"> • No power supply is available. • The battery is soon empty. • The battery has to be replaced. • The battery cannot be detected. • There is another battery problem. • A set threshold has been reached. 	<ul style="list-style-type: none"> • Switch the Mains ON. • Take care that the power supply is available again. • Check the set thresholds and compare with the current status. • Solve the battery problem. • Replace the battery. • Check the cables between UPS and battery. • Verify that the fuse is installed in the battery.

Status bar Symbol	Current situation and possible reason	Possible correction
	The UPS is in battery mode, because no power supply is available.	<ul style="list-style-type: none"> Switch the Mains ON. Take care that the power supply is available again.
	The bridge between the UPS terminals R1 and R2 is removed. Battery is deactivated therefore. Refer to the parameter "Remote Status" in the topic UPS (see page 27).	If you want the battery to be activated and the battery mode to be introduced, when the mains fail, bridge the terminals R1 and R2. Refer to the hardware overview (see page 7).
	<p>There is no power supply available. One of these states is ongoing:</p> <ul style="list-style-type: none"> The UPS is off, because battery mode is finished. The set buffer time has elapsed. The power source is not ok, because input voltage is in an invalid range. 	<p>If the UPS is off, because battery mode is finished, but the battery is functional:</p> <ul style="list-style-type: none"> Switch the Mains ON. Take care that the power supply is available again. <p>If the UPS is off, because battery mode is finished, and the battery is no more functional or at it's end of lifetime:</p> <ul style="list-style-type: none"> Change the battery. <p>If the power source is not ok, because input voltage is in an invalid range:</p> <ul style="list-style-type: none"> Check the power supply.
	The battery is discharging, because no power supply is available.	<ul style="list-style-type: none"> Switch the Mains ON. Take care that the power supply is available again.
	The battery mode is finished, because the battery is empty.	<ul style="list-style-type: none"> Take care that the power supply is available again to reload the battery. Change the battery, if battery lifetime is exhausted.
	(see UPS alarm in the table above)	(see UPS alarm in the table above)
	<ul style="list-style-type: none"> The connection between PC and UPS via the IFS-USB-DATACABLE is interrupted. The communication port is not set. 	<ul style="list-style-type: none"> Connect the UPS and PC via the IFS-USB-DATACABLE. Check if the communication port is set, as described in the topic Communication port (see page 56).

11.2 Communication port

The PC USB communication port for the communication between the UPS and the PC is automatically set during software installation. In case the communication port has not been set, the status bar shows the "Connection to UPS: Offline" status.

Although the communication port has not been set, it is detected automatically. Thus you can set it manually. You just have to select it in the software settings of the system menu.

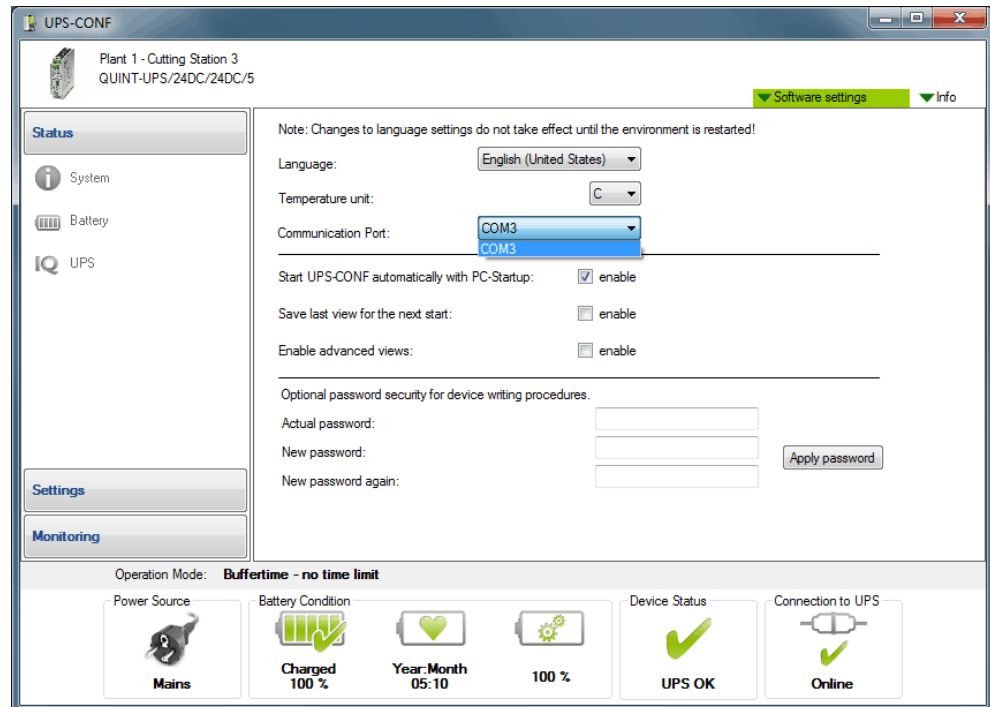

If you click the combo box near the text "Communication port" the correct port is shown and you can select it.

Index

A		I	
Advanced view setting	5	Indication elements	15
Automatic software start	5	IPC connection	14
B		L	
Battery replacement	47	Language setting	5
Battery status	25	Logging	44
Buffer time potentiometer	12	M	
Buffer time setting	12	Memory stick	46
C		N	
Communication port	5	Navigation	15
Configuration parameters	29	O	
Configuration stick	46	Operating elements	15
Custom mode	36	Overview of system functions	1
D		Overview of the user interface	15
Data cable	14	P	
Download web address	5	Parameter settings	29
E		Password setting	5
Emails	31	PC connection	14
Error conditions	53, 54	PC-Mode	36
G		Performance characteristics	1
GUI	15	Port setting	5
H		Preserve last view	5
Hardware overview	7	S	
		Safety information	10

Safety requirements	10
Sending Emails	31
Service mode	47
Service mode rights	39
Service stick	47
Setting advanced parameters	41
Setting parameters	29
Software download	5
Software settings	5
Statistic values	44
Status bar	17
Status symbols	20
Switching outputs	31
Symbols used	4
System requirements	4
T	
time settings	36
Trigger Thresholds	31
U	
UPS status	27
User interface	15
W	
Writing parameters	29



**SCATTERGOOD
& JOHNSON LTD**
ELECTRICAL ENGINEERING & FLUID CONTROL DISTRIBUTORS

Est.1899

At Scattergood & Johnson Ltd, we pride ourselves on being a technical distributor to specialist industries.

Working with a range of quality product suppliers across a number of specialist markets, we are not your average 'box shifter' - we are your technical and supply chain partner.

We fully support every product we sell - for free! Our internal team and external sales engineers can answer any product or application question, no matter the complexity.

Backing up this technical ability is a range of 50,000+ products available from stock for nationwide next day delivery (same day if required!), or you can collect what you need from any of our trade counters around the UK.

Select your specialist interest below to learn more about how we can help.

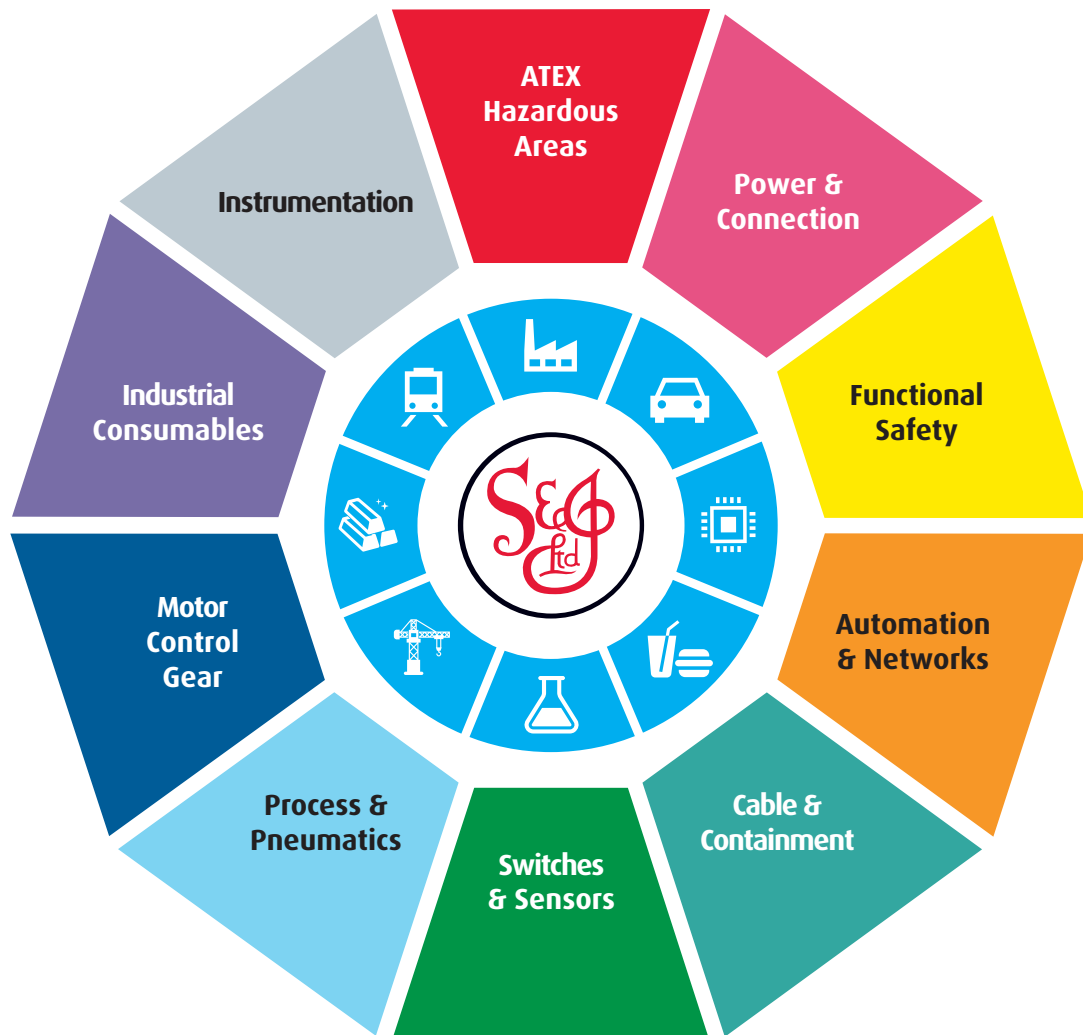

Online, In Branch and On the Road - Scattergood & Johnson Ltd, there when you need us.

www.scatts.co.uk