

# QUINT-PS/3AC/24DC/ 5

## Power supply unit

Data sheet  
103130\_en\_02

© PHOENIX CONTACT 2015-10-20



## 1 Description

QUINT POWER power supply units – Superior system availability with SFB technology

Compact power supply units of the new QUINT POWER generation maximize the availability of your system. With the SFB technology (Selective Fuse Breaking Technology), six times the nominal current for 12 ms, even the standard power circuit-breakers can now also be triggered reliably and quickly. Faulty current paths are switched off selectively, the fault is located and important system parts continue to operate. Comprehensive diagnostics are provided through constant monitoring of output voltage and current. This preventive function monitoring visualizes critical operating modes and reports them to the control unit before an error can occur.

### Features

#### Superior system availability

- Using SFB technology (6 times the nominal current for 12 ms), circuit breakers are tripped quickly and important system parts remain in operation
- Through the preventive monitoring of output voltage and current and the transmission of critical operating states to the controller
- Through reliable starting of difficult loads with POWER BOOST power reserve
- Long mains buffering > 30 ms
- High MTBF > 635,000 h (40°C)

#### Worldwide use

- Input voltage of 3 x 320 V AC ... 575 V AC or 2 x 360 ... 575 V AC
- Input voltage from 450 V DC ... 800 V DC

#### Flexible use

- Adjustable output voltage
- Can be used in Class I, Division 2, Groups A, B, C, D (Hazardous Location) ANSI-ISA 12.12



Make sure you always use the latest documentation.  
It can be downloaded from the product at [phoenixcontact.net/products](http://phoenixcontact.net/products).

<b>2</b>	<b>Table of contents</b>	
1	Description .....	1
2	Table of contents .....	2
3	Ordering data .....	3
4	Technical data .....	4
5	Safety regulations and installation notes.....	8
6	Structure .....	9
	6.1 Block diagram .....	9
	6.2 Function elements .....	9
	6.3 Convection.....	10
	6.4 Mounting position .....	11
7	Mounting/removal .....	12
	7.1 Normal mounting position .....	12
	7.2 Mounting position rotated 90° .....	12
	7.3 Mounting on a DIN rail .....	12
	7.4 Removal from the DIN rail .....	12
8	Device connection .....	13
	8.1 Network types.....	13
	8.2 AC input .....	13
	8.3 DC output .....	14
9	SFB technology .....	14
	9.1 Circuit breaker tripping characteristics .....	14
	9.2 Installation notes .....	14
	9.3 SFB configuration .....	15
10	Signaling.....	17
	10.1 Floating switch contact.....	17
	10.2 Active signal outputs.....	17
	10.3 Signal loop.....	18
11	Derating.....	18
	11.1 Temperature-dependent derating .....	18
12	Operating modes .....	18
	12.1 Series operation .....	18
	12.2 Parallel operation.....	18
	12.3 Redundant operation .....	19
	12.4 Increasing power .....	19

### 3 Ordering data

Description	Type	Order No.	Pcs./Pkt.
Primary-switched QUINT POWER power supply for DIN rail mounting with SFB (Selective Fuse Breaking) Technology, input: 3-phase, output: 24 V DC/5 A	QUINT-PS/3AC/24DC/ 5	2866734	1
Accessories	Type	Order No.	Pcs./Pkt.
Universal DIN rail adapter	UTA 107/30	2320089	100
Universal wall adapter	UWA 182/52	2938235	1
Assembly adapter for QUINT-PS... power supply on S7-300 rail	QUINT-PS-ADAPTERS7/1	2938196	1
The fan for QUINT-PS/1AC and .../3AC can be mounted without the need for tools or other accessories. By using the fan, optimum cooling is ensured at high ambient temperatures or if the mounting position is rotated.	QUINT-PS/FAN/4	2320076	1
DIN rail diode module 12-24 V DC/2x20 A or 1x40 A. Uniform redundancy up to the consumer.	QUINT-DIODE/12-24DC/2X20/1X40	2320157	1
Active QUINT redundancy module for DIN rail mounting with ACB technology (Active Current Balancing) and monitoring functions, input: 24 V DC, output: 24 V DC/2 x 10 A or 1 x 20 A, including mounted universal DIN rail adapter UTA 107/30	QUINT-ORING/24DC/2X10/1X20	2320173	1
Redundancy module with function monitoring, 12-24 V DC, 2x 10 A, 1x 20 A	TRIO-DIODE/12-24DC/2X10/1X20	2866514	1
Thermomagnetic device circuit breaker, 1-pos., tripping characteristic SFB, 1 PDT contact, plug for base element.	CB TM1 1A SFB P	2800836	1
Thermomagnetic device circuit breaker, 1-pos., tripping characteristic SFB, 1 PDT contact, plug for base element.	CB TM1 2A SFB P	2800837	1



Our range of accessories is being continually extended, our current range can be found in the download area.

## 4 Technical data

Input data	
Nominal input voltage	3x 400 V AC ... 500 V AC
Input voltage range	2x 360 V AC ... 575 V AC 3x 320 V AC ... 575 V AC
Input voltage range	450 V DC ... 800 V DC
AC frequency range	45 Hz ... 65 Hz
Frequency range DC	0 Hz
Current consumption	3x 0.8 A (400 V AC) 3x 0.7 A (500 V AC) 0.2 A (600 V DC)
Inrush current limitation	< 15 A (typical)
$I^2t$	< 1 A <sup>2</sup> s
Power failure bypass	> 20 ms (400 V AC) > 30 ms (500 V AC)
Typical response time	< 0.06 s
Protective circuit	Transient surge protection Varistor, gas-filled surge arrester
Choice of suitable circuit breakers	6 A ... 16 A (AC: Characteristics B, C, D, K)
Discharge current to PE	< 3.5 mA
Output data	
Nominal output voltage	24 V DC $\pm$ 1 %
Setting range of the output voltage	18 V DC ... 29.5 V DC (> 24 V DC, constant capacity restricted)
Output current	5 A (-25°C ... 60°C, $U_{OUT} = 24$ V DC) 7.5 A (with POWER BOOST, -25°C ... 40°C permanently, $U_{OUT} = 24$ V DC) 30 A (SFB technology, 12 ms) 7.5 A ( $U_{IN} \geq 100$ V AC, $\geq 110$ V DC)
Magnetic circuit breaker tripping	B2 / B4 / C2
Efficiency	> 89 % (at 400 V AC and nominal values)
Rise time	< 0.04 s ( $U_{OUT}$ (10 % ... 90 %))
Residual ripple	< 20 mV <sub>PP</sub> (with nominal values)
Connection in parallel	Yes, for redundancy and increased capacity
Connection in series	Yes
Protection against surge voltage on the output	< 35 V DC
Resistance to reverse feed	max. 35 V DC
Power consumption	
Maximum power dissipation in no-load condition	4 W
Power loss nominal load max.	14 W
DC OK active	
Output description	$U_{OUT} > 0.9 \times U_N$ : High signal
Voltage/current	18 V DC ... 24 V DC / $\leq 20$ mA (short-circuit resistant)
Status display	$U_{OUT} > 0.9 \times U_N$ : "DC OK" LED green / $U_{OUT} < 0.9 \times U_N$ : Flashing "DC OK" LED
DC OK floating	
Output description	Relay contact, $U_{OUT} > 0.9 \times U_N$ : Contact closed
Voltage/current	30 V AC/DC / 0.5 A , 24 V DC / 1 A
Status display	$U_{OUT} > 0.9 \times U_N$ : "DC OK" LED green / $U_{OUT} < 0.9 \times U_N$ : Flashing "DC OK" LED

**POWER BOOST, active**

Output description	$I_{OUT} < I_N$ : High signal
Voltage/current	18 V DC ... 24 V DC / $\leq 20$ mA (short-circuit resistant)
Status display	$I_{OUT} > I_N$ : LED "BOOST" yellow

**General data**

Insulation voltage input/output	4 kV AC (type test) 2 kV AC (routine test)
Insulation voltage input / PE	3.5 kV AC (type test) 2 kV AC (routine test)
Insulation voltage output / PE	500 V DC (routine test)
Degree of protection	IP20
Protection class	I
MTBF (IEC 61709, SN 29500)	> 680000 h (40°C) / > 1290000 h (25 °C)
Side element version	Aluminum
Hood version	Galvanized sheet steel, free from chrome (VI)
Dimensions W / H / D (state of delivery)	40 mm / 130 mm / 125 mm
Dimensions W / H / D (90° turned)	122 mm / 130 mm / 43 mm
Weight	0.7 kg

**Ambient conditions**

Ambient temperature (operation)	-25 °C ... 70 °C (> 60 °C Derating: 2,5 %/K)
Ambient temperature (start-up type tested)	-40 °C
Ambient temperature (storage/transport)	-40 °C ... 85 °C
Max. permissible relative humidity (operation)	$\leq 95$ % (at 25 °C, non-condensing)
Maximum altitude	5000 m
Vibration (operation)	< 15 Hz, amplitude $\pm 2.5$ mm (according to IEC 60068-2-6) 15 Hz ... 150 Hz, 2.3g, 90 min.
Shock	30g in each direction, according to IEC 60068-2-27
Pollution degree in acc. with EN 60950-1	2
Climatic class	3K3 (in acc. with EN 60721)

**Standards**

Electrical Equipment for Machinery	EN 60204-1
Electrical safety (of information technology equipment)	IEC 60950-1/VDE 0805 (SELV)
Electronic equipment for use in electrical power installations	EN 50178/VDE 0160 (PELV) / Overvoltage category III
SELV	IEC 60950-1 (SELV) and EN 60204-1 (PELV)
Safe isolation	DIN VDE 0100-410
Protection against electric shock, basic requirements for safe isolation in electrical equipment	EN 50178
Limitation of mains harmonic currents	EN 61000-3-2
Network version/undervoltage	SEMI F47-0706 Compliance Certificate
Medical standard	IEC 60601-1, 2 x MOOP
Rail applications	EN 50121-4

**Approvals**

UL	UL Listed UL 508 UL/C-UL Recognized UL 60950-1 (3-wire + PE, star net) UL ANSI/ISA-12.12.01 Class I, Division 2, Groups A, B, C, D (Hazardous Location)
CSA	CAN/CSA-C22.2 No. 60950-1-07 CSA-C22.2 No. 107.1-01
SIQ	CB Scheme
Shipbuilding	Germanischer Lloyd (EMC 2), ABS, LR, RINA, NK, DNV, BV 



Current approvals/permissions for the product can be found in the download area under [phoenixcontact.net/products](http://phoenixcontact.net/products).

**Conformance with EMC Directive 2004/108/EC****Noise immunity according to EN 61000-6-2**

	EN 61000-6-2 requirement	Tested
<b>Electrostatic discharge EN 61000-4-2</b>		
Housing contact discharge	4 kV (Test Level 2)	8 kV (Test Level 4)
Housing air discharge	8 kV (Test Level 3)	15 kV (Test Level 4)
Comments	Criterion B	Criterion A
<b>Electromagnetic HF field EN 61000-4-3</b>		
Frequency range	80 MHz ... 1 GHz	80 MHz ... 1 GHz
Test field strength	10 V/m (Test Level 3)	20 V/m (Test Level 3)
Frequency range	1.4 GHz ... 2 GHz	1 GHz ... 2 GHz
Test field strength	3 V/m (Test Level 2)	10 V/m (Test Level 3)
Frequency range	2 GHz ... 2.7 GHz	2 GHz ... 3 GHz
Test field strength	1 V/m (Test Level 1)	10 V/m (Test Level 3)
Comments	Criterion A	Criterion A
<b>Fast transients (burst) EN 61000-4-4</b>		
Input	2 kV (Test Level 3 - asymmetrical)	4 kV (Test Level 4 - asymmetrical)
Output	2 kV (Test Level 3 - asymmetrical)	2 kV (Test Level 3 - asymmetrical)
Signal	1 kV (Test Level 3 - asymmetrical)	2 kV (Test Level 4 - asymmetrical)
Comments	Criterion B	Criterion A
<b>Surge current loads (surge) EN 61000-4-5</b>		
Input	1 kV (Test Level 2 - symmetrical) 2 kV (Test Level 3 - asymmetrical)	2 kV (Test Level 3 - symmetrical) 4 kV (Test Level 4 - asymmetrical)
Output	0.5 kV (Test Level 1 - symmetrical) 0.5 kV (Test Level 1 - asymmetrical)	1 kV (Test Level 2 - symmetrical) 2 kV (Test Level 3 - asymmetrical)
Signal	1 kV (Test Level 2 - asymmetrical)	1 kV (Test Level 2 - asymmetrical)
Comments	Criterion B	Criterion B
<b>Conducted interference EN 61000-4-6</b>		
Input/Output/Signal	asymmetrical	asymmetrical
Frequency range	0.15 MHz ... 80 MHz	0.15 MHz ... 80 MHz
Voltage	10 V (Test Level 3)	10 V (Test Level 3)
Comments	Criterion A	Criterion A

**Key**

Criterion A

Normal operating behavior within the specified limits.

Criterion B

Temporary impairment to operational behavior that is corrected by the device itself.

**Emitted interference in acc. with EN 61000-6-3**

Radio interference voltage in acc. with EN 55011

EN 55011 (EN 55022) Class B, area of application: Industry and residential

Emitted radio interference in acc. with EN 55011

EN 55011 (EN 55022) Class B, area of application: Industry and residential



All technical specifications are nominal and refer to a room temperature of 25 °C and 70% relative humidity at 2000 m above sea level.

## 5 Safety regulations and installation notes

**EXPLOSION HAZARD!**

Only remove equipment when it is disconnected and not in the potentially explosive area.

**DANGER**

Components with dangerously high voltage and high stored energy are located in the device!

Never carry out work on live parts!

Depending on the ambient temperature and the load, the housing can become very hot!

**CAUTION:**

Before startup please ensure:

The connection must be carried out by a competent person and protection against electric shock guaranteed.

It must be possible to switch off power to device according to EN 60950.

All feed lines are sufficiently protected and dimensioned!

All output lines are dimensioned according to the maximum output current of the device or separately protected!

Sufficient convection must be guaranteed.

Observe mechanical and thermal limits.

**CAUTION: Risk of injury**

Cover termination area after installation in order to avoid accidental contact with live parts (e. g., installation in control cabinet).

**NOTE: Danger if used improperly**

The power supply units are built-in devices. The device may only be installed and put into operation by qualified personnel. The corresponding national regulations must be observed.

## 6 Structure

### 6.1 Block diagram

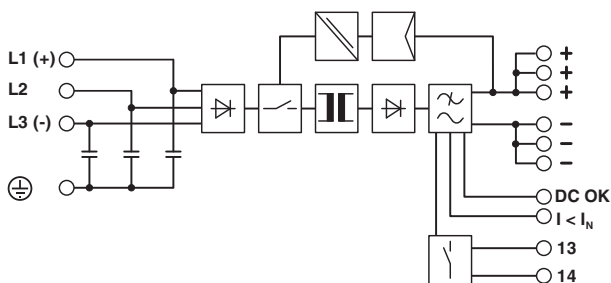

Element	Meaning
	Rectification
	Power factor correction filter
	Switch
	Electrically isolated signal transmission
	Regulation
	Transformer
	Output filter
	Floating switching output

### 6.2 Function elements

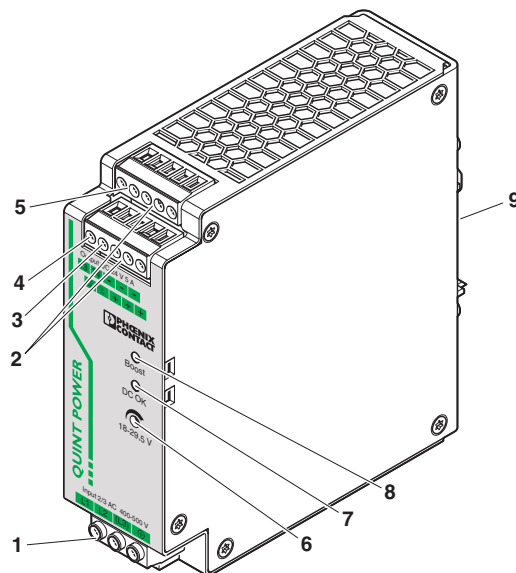

Figure 1 Position of the function elements

No.	Connection terminal blocks and function elements
1	AC input
2	DC output
3	Active signal output $I < I_N$ (POWER BOOST)
4	Active DC OK signal output
5	Floating DC OK switching output
6	Potentiometer for setting the output voltage
7	DC OK signal LED, green
8	Signal LED boost, yellow
9	Universal DIN rail adapter

### 6.3 Convection

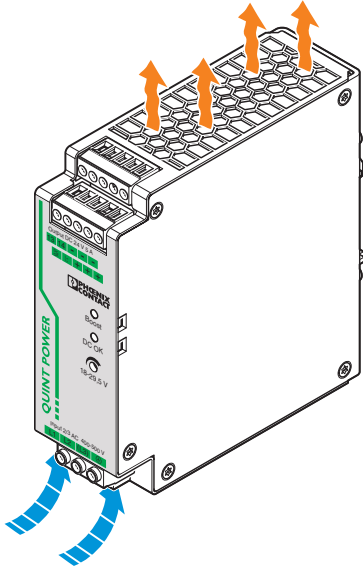

Figure 2 Convection



**NOTE: enable convection**

The housing can become very hot, depending on the ambient temperature and module load. To enable sufficient convection, we recommend a minimum vertical clearance of 50 mm from other modules. In order to ensure proper functioning of the module, it is necessary to maintain a lateral distance of 5 mm and 15 mm for active components.



The device can be snapped onto all DIN rails in accordance with EN 60715 and should be mounted in the normal mounting position (connection terminal blocks on top and bottom).

## 6.4 Mounting position

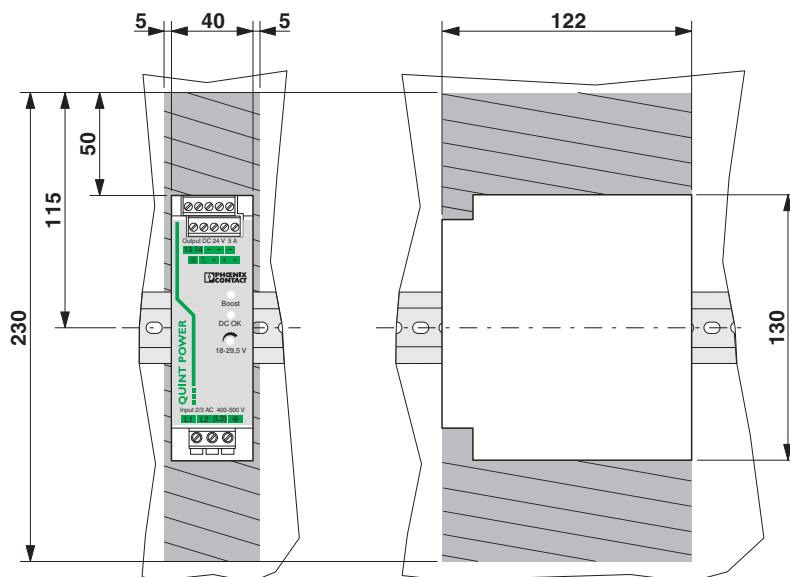

Figure 3 Locked areas

### Possible mounting positions:

Normal mounting position, installation depth 125 mm (+ DIN rail) (delivery state)

Mounting position rotated at 90°, installation depth of 43 mm (+ DIN rail)

## 7 Mounting/removal

### 7.1 Normal mounting position

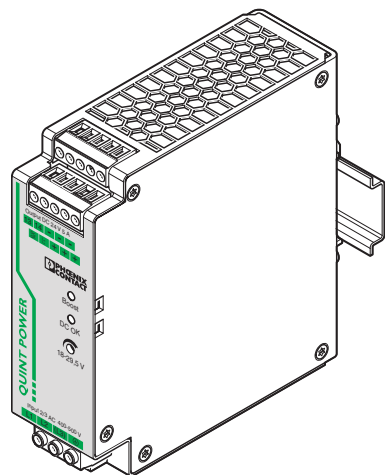

Figure 4 Normal mounting position

### 7.2 Mounting position rotated 90°

For a mounting position rotated at 90° to the DIN rail, mount the DIN rail adapter (UTA 107) as shown in the figure. No additional assembly material is required. Mounting screws: Torx® T10 (0.8 Nm ... 0.9 Nm tightening torque).

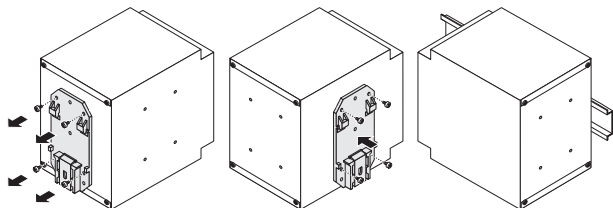

Figure 5 Mounting position rotated 90°

### 7.3 Mounting on a DIN rail

Position the module with the DIN rail guide on the upper edge of the DIN rail, and snap it in with a downward motion.

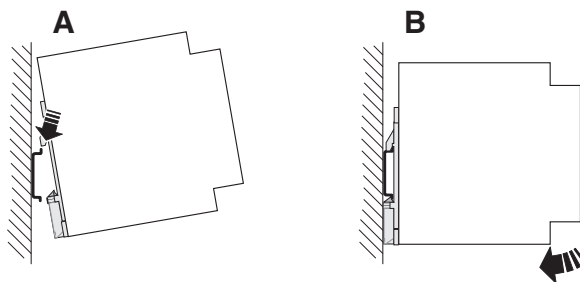

Figure 6 Assembly

### 7.4 Removal from the DIN rail

Pull the snap lever open with the aid of a screwdriver and slide the module out at the lower edge of the DIN rail.

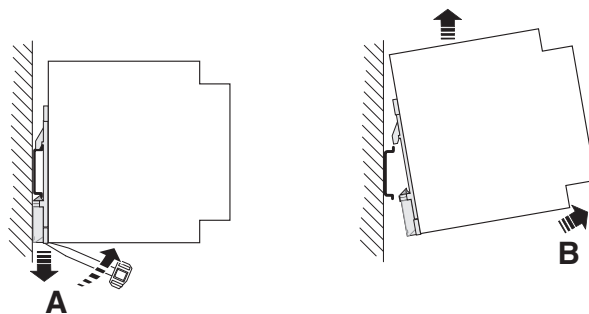

Figure 7 Removal

## 8 Device connection

### 8.1 Network types

The device can be connected to 2- or 3-phase AC networks with nominal voltages 2x/3x 400 V AC ... 500 V AC.

The 2x or 3x 400 V AC ... 500 V AC connection is made using the L1, L2, L3 and PE screw connections.

When connecting the three phases L1, L2 and L3, continuous operation at nominal capacity is ensured without limitations when one of the phases fails.



For operation on two of the phase conductors of a three-phase system, an isolating facility for all poles must be provided.

A maximum outer conductor voltage of 400 V is permitted for operation in IT networks.

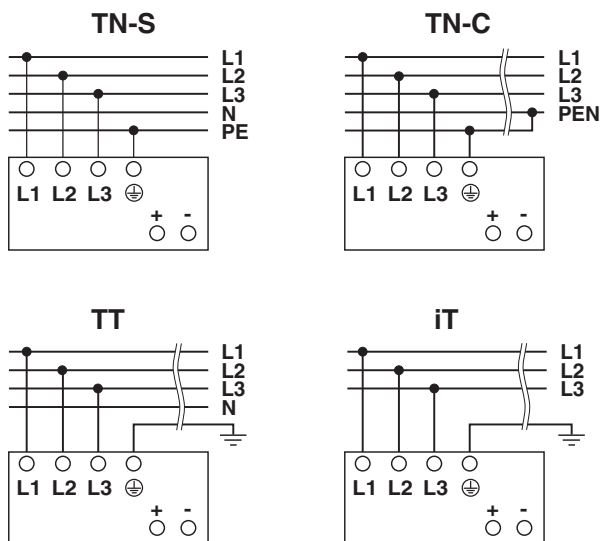

**NOTE:**

In DC applications, a suitable fuse must be wired upstream!  
Connect not more than one power supply unit to a fuse or a power switch.

Suggestion: In AC connections, connect a maximum of one power supply unit to a fuse or a power switch.

In order to comply with UL approval, use copper cables with an operating temperature of > 75°C (ambient temperature < 55°C) and > 90°C (ambient temperature < 75°C).

### 8.2 AC input

The supply voltage is connected via "Input 2/3 AC 400 - 500 V" connection terminal blocks.

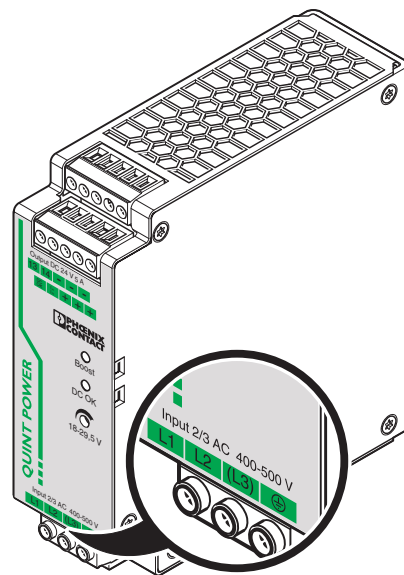

#### 8.2.1 Protection of the primary side

The device must be installed in acc. with the regulations as in EN 60950. It must be possible to disconnect the device using a suitable isolating facility outside the power supply. Primary circuit mains protection, for example, is suitable for this purpose.

#### 8.2.2 Required backup fuse (device and line protection)

External thermo-magnetic fuses are necessary for device protection: 2/3 x 6 A, 10 A or 16 A power circuit breaker, characteristic B, C, D, K (or identical function).

Connect a suitable fuse upstream for DC applications!



**CAUTION:**

If an internal fuse is triggered, there is a device malfunction. In this case, the device must be inspected in the factory.

### 8.3 DC output

The output voltage is connected via the "Output DC" connection terminal blocks.

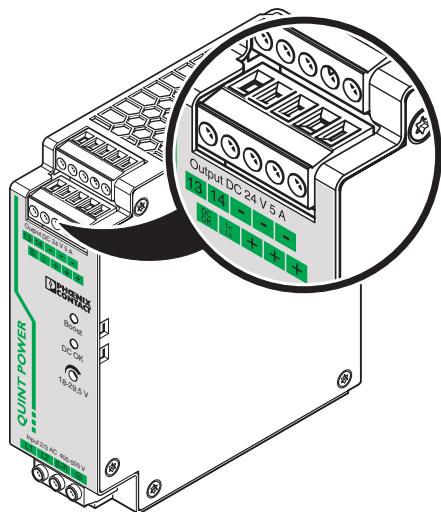

#### 8.3.1 Protection of the secondary side

The device is electronically short-circuit-proof and idling-proof. In the event of an error, the output voltage is limited. It must be ensured that all output cables are dimensioned or separately protected according to the maximum output current.

#### 8.3.2 Output characteristic curve

The module functions according to the U/I characteristic curve with the static POWER BOOST power reserve. At a constant output voltage  $U_N$ ,  $I_{BOOST}$  is available. This  $I_{BOOST}$  current supplies up to 1.5 times the  $I_N$  nominal output current. High inrush currents are therefore absorbed without voltage dips.

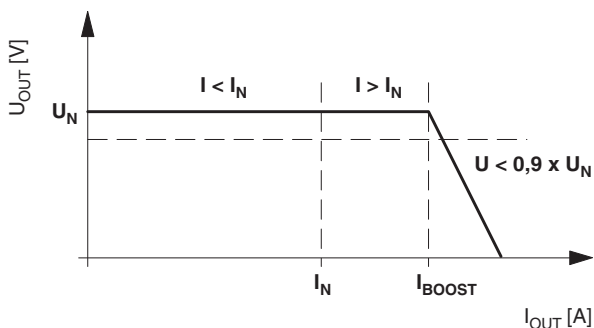

$U_N = 24 \text{ V}$

$I_N = 5 \text{ A}$

$I_{BOOST} = 7.5 \text{ A}$

SFB technology = 30 A (12 ms)

$P_N = 120 \text{ W}$

$P_{BOOST} = 180 \text{ W}$

## 9 SFB technology

SFB (Selective Fuse Breaking) technology reliably switches off faulty current paths in the event of a short circuit. In this case, it supplies up to six times the nominal current for 12 ms. SFB technology therefore reliably triggers standard circuit breakers. Faults are located reliably and important system parts remain in operation.

### 9.1 Circuit breaker tripping characteristics

Typically, a circuit breaker trips within 3 ... 5 ms. Fast enough to avoid voltage drops of parallel connected loads.

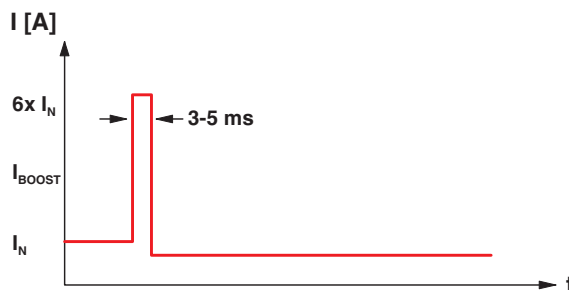

Tripping time of the circuit breaker = 3 - 5 ms, typically

### 9.2 Installation notes

To use the SFB technology of the QUINT power supply, you must observe the following requirements:

- When designing the secondary side, consider the configuration matrix that describes the maximum cable lengths depending on the performance class of the devices, cable cross section, and the circuit breaker.



The current configuration matrix can be found in the product download area.

- Ensure the lowest possible cable impedance at the input of the power supply by using short cable lengths and large cable cross sections.



Observe the maximum distance between the source to be supplied and the load. (see also SFB configuration)

### 9.3 SFB configuration

#### 9.3.1 Standard circuit breakers

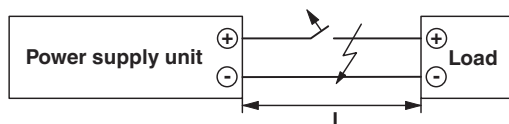

Figure 8 Cable lengths

#### Maximum distance between the power supply and load (l)

Cross section [ $\text{mm}^2$ ]	0.75	1.0	1.5	2.5
Distance l with C2 circuit breaker [m]	5	7	11	19

The following parameters are the basis for calculation:

- Circuit breaker from Siemens, B and C characteristics (e. g., B6: 5SY6106-6)
- B characteristic: electromagnetic tripping of the circuit breaker at the latest at (5-fold rated current) x (correction factor 1.2 at 0 Hz) = 6-fold rated current
- C characteristic: electromagnetic tripping of the circuit breaker at the latest at (10-fold rated current) x (correction factor 1.2 at 0 Hz) = 12-fold rated current
- Ambient temperature: +20 °C
- The internal resistances of the circuit breakers are considered.
- In addition to short circuit current, the relevant power supply unit supplies half of the nominal current for paths connected in parallel.

### 9.3.2 CB TM1 SFB device circuit breaker

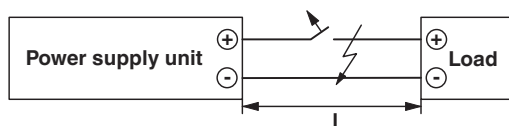

Figure 9 Cable lengths

#### Maximum distance between the power supply and load (l)

Cross section [ $\text{mm}^2$ ]	0.75	1.0	1.5	2.5
Spacing with CB TM1 1A SFB P [m]	27	36	54	91
Spacing with CB TM1 2A SFB P [m]	10	13	20	34

The following parameters are the basis for calculation:

- CB TM1 xA SFB P device circuit breaker
- Electromagnetic triggering of the circuit breaker at the latest at (10 times the rated current)
- Ambient temperature: +20 °C
- The internal resistance of the device circuit breakers is taken into account
- In addition to short circuit current, the relevant power supply unit supplies half of the nominal current for paths connected in parallel.

## 10 Signaling

The following are available for function monitoring:

- The active signal output DC OK
- The floating DC OK output
- The active POWER BOOST signal output

In addition, the "DC OK" and "BOOST" LEDs can be used to evaluate the function of the power supply directly at the installation location (see output characteristic curve).

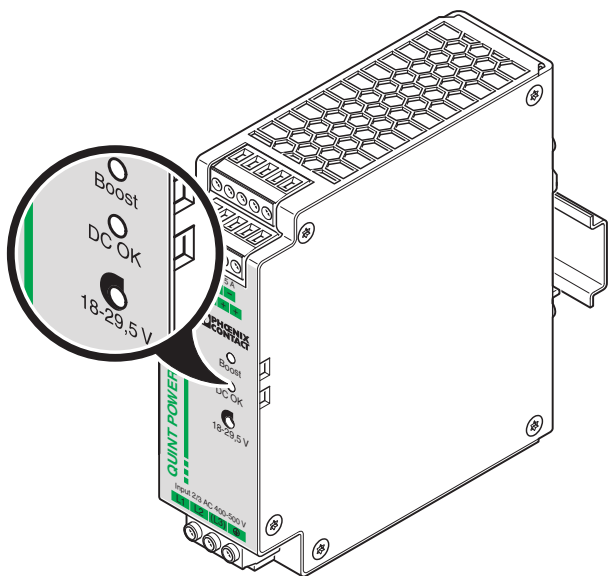

Figure 10 Signal outputs



If the output voltage falls below 90% of the output voltage set on the potentiometer as a result of overloading, the signal state "DC OK" switches from "Active High" to "Low". The limit value of 90% always refers to the set output voltage range of 18 V DC to 29.5 V DC.

	Normal operation $I < I_N$	POWER BOOST $I > I_N$	Overload mode $U_{OUT} < 0.9 \times U_N$
"DC OK" LED, green	lit	lit	Flashing
"BOOST" LED, yellow	OFF	lit	lit
"DC OK" signal	ON	ON	OFF
"DC OK" relay	closed	closed	opened
Signal " $I < I_N$ "	ON	OFF	OFF
Meaning	Normal operation of the power supply unit ( $U_{OUT} > 21.5$ V)	POWER BOOST mode, e.g., for starting loads	Overload mode, e. g., load short circuit or overload

### 10.1 Floating switch contact

The floating switch contact opens to indicate that the set output voltage has been undershot by more than 10 % ( $U_{OUT} < 0.9 \times U_N$ ). Signals and ohmic loads can be switched. For heavily inductive loads such as a relay, a suitable protective circuit (e.g., freewheeling diode) is necessary.

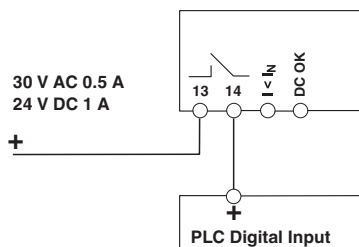

### 10.2 Active signal outputs

For the transmission of signals to a higher-level controller, the active "DC OK" and "Boost" signal outputs can be used. The 18 ... 24 V DC signal is applied between the "DC OK" and "-" (active DC OK signal output) or between " $I < I_N$ " and "-" (active POWER BOOST signal output) and can withstand a maximum of 20 mA.

By switching from "active high" to "low", the DC OK signal output indicates that the set output voltage has been undershot by more than 10 % ( $U_{OUT} < 0.9 \times U_N$ ). The DC OK signal is decoupled from the power output. This makes it impossible for devices connected in parallel to act as an external power supply.

The BOOST signal output " $I < I_N$ " indicates that the nominal current has been exceeded. The power supply then switches to POWER BOOST mode. Thanks to this preventive function monitoring, critical operating states can be recognized at an early stage, prior to a voltage dip occurring.

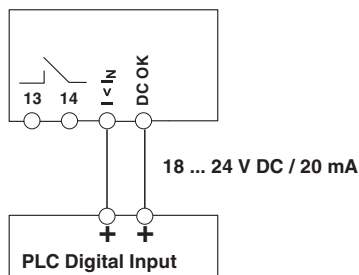

### 10.3 Signal loop

Monitoring of two devices: use the active DC OK signal output of device 1 and loop the floating alarm output of device 2. In the event of a malfunction, you will receive a group error message. Any number of devices can be looped. This signal combination saves wiring costs and logic inputs.

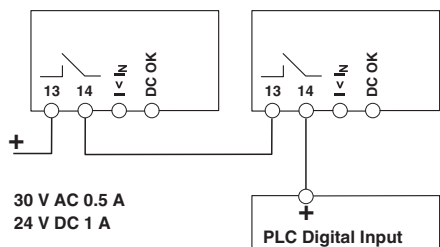

## 11 Derating

### 11.1 Temperature-dependent derating

At an ambient temperature of  $-25\text{ }^{\circ}\text{C}$  to  $+40\text{ }^{\circ}\text{C}$ , the device continuously supplies the  $I_{\text{BOOST}}$  output current. The device can supply the  $I_{\text{N}}$  nominal output current up to an ambient temperature of  $+60\text{ }^{\circ}\text{C}$ . At ambient temperatures above  $+60\text{ }^{\circ}\text{C}$ , the output power must be decreased by 2.5 % per Kelvin increase in temperature. At ambient temperatures above  $+70\text{ }^{\circ}\text{C}$  or in the event of a thermal overload, the device does not switch off. The output power is decreased to such an extent that device protection is provided. Once the device has cooled down, the output power is increased again.

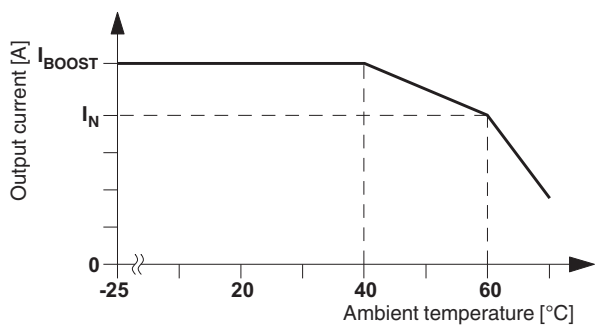

## 12 Operating modes

### 12.1 Series operation

Two power supplies can be switched in series, to double the output voltage. For connection in series, only power supplies of the same performance class should be used. An output voltage of 48 V DC can be provided, if two 24 V power supplies are connected in series.

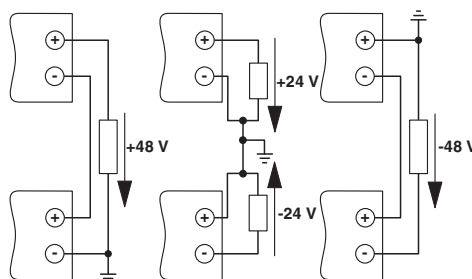

Figure 11 Series operation

### 12.2 Parallel operation

Devices of the same type can be connected in parallel to increase both redundancy and power. No further adjustments are necessary for the default setting.

If the output voltage of a power supply unit is adjusted, all power supplies connected in parallel must be set to the same output voltage in order to ensure an even distribution of current.

In order to ensure symmetrical current distribution, we recommend that all cable connections from the power supply unit to the busbar are the same length and have the same cross section.

Depending on the system, a protective circuit should be installed at each individual device output (e.g., decoupling diode, DC fuse or circuit breaker) for parallel connection of more than two power supplies. This prevents high return currents in the event of a secondary device fault.

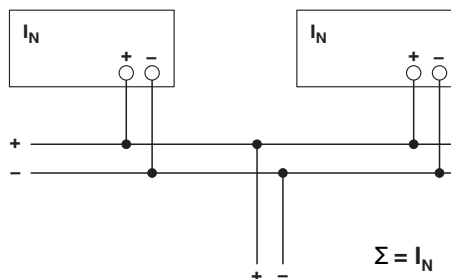

### 12.3 Redundant operation

Redundant circuits are suitable for supplying systems which place particularly high demands on operational safety. If a 1+1 redundancy is implemented, this means that for a load of 20 A, two modules each with 20 A must be connected in parallel on the output side. In the event of an internal device fault or failure of the mains power supply on the primary side, the second module automatically takes over the entire supply of the loads.

Optimization of redundancy can be achieved by decoupling and monitoring. Phoenix Contact offers a comprehensive product range for this purpose (e. g., QUINT-DIODE or QUINT-ORING).

#### Example: diode module

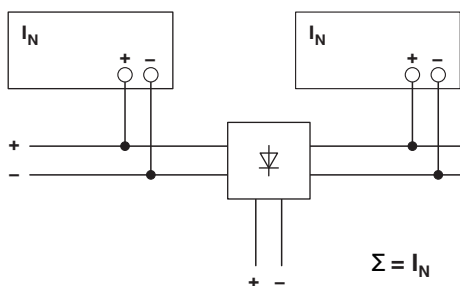

#### Example: QUINT ORING

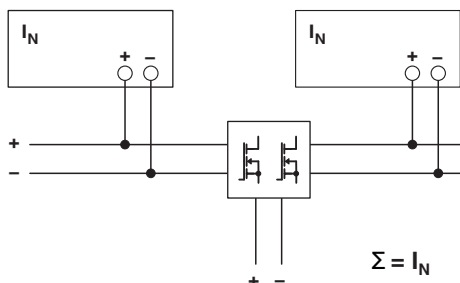

### 12.4 Increasing power

The output current can be increased to  $n \times I_N$  in the case of  $n$  parallel connected devices. Parallel connection for increasing power is used when extending existing systems. A parallel connection is recommended if the power supply unit does not cover the current consumption of the most powerful load. Otherwise, the load should be distributed between individual devices that are independent from one another.

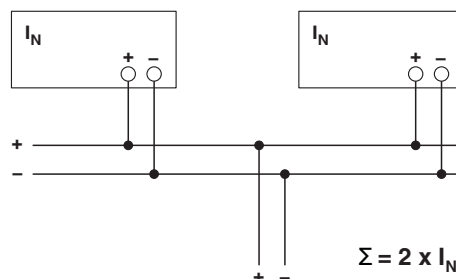



# SCATTERGOOD & JOHNSON LTD

ELECTRICAL ENGINEERING & FLUID CONTROL DISTRIBUTORS

Est.1899

At Scattergood & Johnson Ltd, we pride ourselves on being a technical distributor to specialist industries.

Working with a range of quality product suppliers across a number of specialist markets, we are not your average 'box shifter' - we are your technical and supply chain partner.

We fully support every product we sell - for free! Our internal team and external sales engineers can answer any product or application question, no matter the complexity.

Backing up this technical ability is a range of 50,000+ products available from stock for nationwide next day delivery (same day if required!), or you can collect what you need from any of our trade counters around the UK.

Select your specialist interest below to learn more about how we can help.

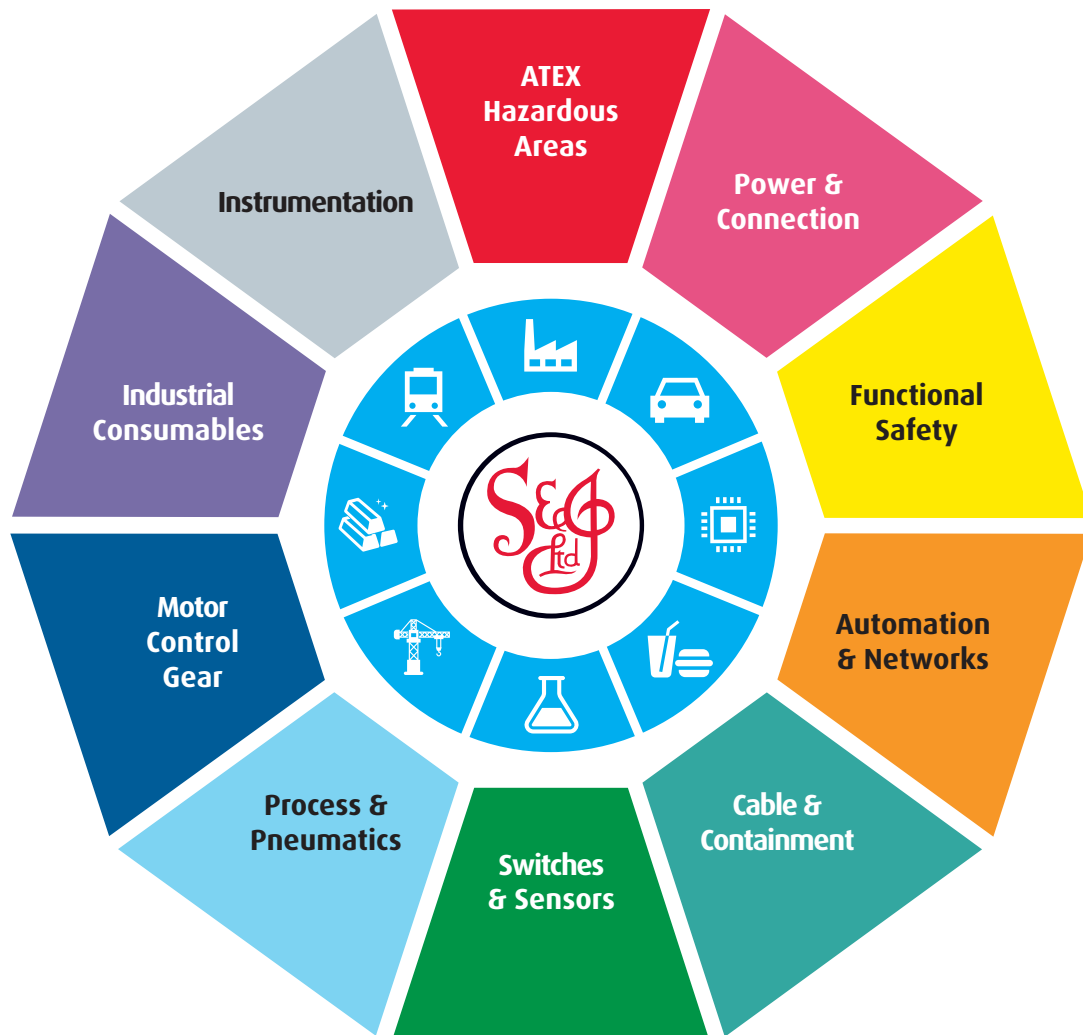

Online, In Branch and On the Road - Scattergood & Johnson Ltd, there when you need us.

# [www.scatts.co.uk](http://www.scatts.co.uk)