

## Power supply unit - QUINT-PS/1AC/24DC/ 3.5 - 2866747

Please be informed that the data shown in this PDF Document is generated from our Online Catalog. Please find the complete data in the user's documentation. Our General Terms of Use for Downloads are valid (<http://phoenixcontact.com/download>)



Primary-switched QUINT POWER power supply for DIN rail mounting with SFB (Selective Fuse Breaking) Technology, input: 1-phase, output: 24 V DC/3.5 A

### Product Description

QUINT POWER power supplies with maximum functionality

QUINT POWER circuit breakers magnetically and therefore quickly trip at six times the nominal current, for selective and therefore cost-effective system protection. The high level of system availability is additionally ensured, thanks to preventive function monitoring, as it reports critical operating states before errors occur.

Reliable starting of heavy loads takes place via the static power reserve POWER BOOST. Thanks to the adjustable voltage, all ranges between 5 V DC ... 56 V DC are covered.

### Your advantages

- ✓ Reliable starting of difficult loads with the static POWER BOOST power reserve with up to 1.5 times the nominal current permanently
- ✓ Fast tripping of standard circuit breakers with dynamic power reserve SFB (selective fuse breaking) technology with up to 6 times the nominal current for 12 ms
- ✓ For superior system availability
- ✓ Preventive function monitoring



### Key Commercial Data

Packing unit	1 pc
GTIN	 4 046356 113779
GTIN	4046356113779
Weight per Piece (excluding packing)	500.000 g
Custom tariff number	85044030
Country of origin	Thailand

### Technical data

#### Dimensions

Width	32 mm
Height	130 mm
Depth	125 mm

# Power supply unit - QUINT-PS/1AC/24DC/ 3.5 - 2866747

## Technical data

### Dimensions

Width with alternative assembly	122 mm
Height with alternative assembly	130 mm
Depth with alternative assembly	35 mm

### Ambient conditions

Degree of protection	IP20
Ambient temperature (operation)	-25 °C ... 70 °C (> 60 °C Derating: 2.5 %/K)
Ambient temperature (storage/transport)	-40 °C ... 85 °C
Max. permissible relative humidity (operation)	≤ 95 % (at 25 °C, non-condensing)
Climatic class	3K3 (in acc. with EN 60721)
Degree of pollution	2
Installation height	5000 m

### Input data

Nominal input voltage range	100 V AC ... 240 V AC
Input voltage range	85 V AC ... 264 V AC
	90 V DC ... 350 V DC
Dielectric strength maximum	300 V AC
AC frequency range	45 Hz ... 65 Hz
Frequency range DC	0 Hz
Discharge current to PE	< 3.5 mA
Current consumption	1.4 A (120 V AC)
	0.8 A (230 V AC)
	0.9 A (110 V DC)
	0.4 A (220 V DC)
Nominal power consumption	180 VA
Inrush current	< 20 A (typical)
Mains buffering time	typ. 20 ms (120 V AC)
	typ. 80 ms (230 V AC)
Input fuse	5 A (slow-blow, internal)
Recommended breaker for input protection	6 A ... 20 A (AC: Characteristics B, C, D, K)
Type of protection	Transient surge protection
Protective circuit/component	Varistor

### Output data

Nominal output voltage	24 V DC ±1 %
Setting range of the output voltage ( $U_{Set}$ )	18 V DC ... 29.5 V DC (> 24 V DC, constant capacity restricted)
Nominal output current ( $I_N$ )	3.5 A (-25 °C ... 60 °C, $U_{OUT} = 24$ V DC)
POWER BOOST ( $I_{Boost}$ )	4 A (-25 °C ... 40 °C permanent, $U_{OUT} = 24$ V DC )
Selective Fuse Breaking ( $I_{SFB}$ )	15 A (12 ms)
Derating	60 °C ... 70 °C (2.5%/K)
Connection in parallel	Yes, for redundancy and increased capacity

## Power supply unit - QUINT-PS/1AC/24DC/ 3.5 - 2866747

### Technical data

#### Output data

Connection in series	yes
Feedback voltage resistance	max. 35 V DC
Protection against overvoltage at the output (OVP)	< 35 V DC
Control deviation	< 1 % (change in load, static 10 % ... 90 %)
	< 2 % (change in load, dynamic 10 % ... 90 %)
	< 0.1 % (change in input voltage $\pm 10$ %)
Residual ripple	< 50 mV <sub>PP</sub> (with nominal values)
Output power	84 W
Typical response time	< 0.05 s
Maximum power dissipation in no-load condition	3.5 W
Power loss nominal load max.	11 W

#### General

Net weight	0.5 kg
Operating voltage display	Green LED
Efficiency	> 88 % (for 230 V AC and nominal values)
Insulation voltage input/output	4 kV AC (type test)
	2 kV AC (routine test)
Insulation voltage input / PE	3.5 kV AC (type test)
	2 kV AC (routine test)
Insulation voltage output / PE	500 V DC (routine test)
Protection class	I
Degree of protection	IP20
MTBF (IEC 61709, SN 29500)	> 1433000 h (25 °C)
	> 820000 h (40 °C)
	> 360000 h (60 °C)
Mounting position	horizontal DIN rail NS 35, EN 60715
Assembly instructions	alignable: $P_N \geq 50\%$ , 5 mm horizontally, 15 mm next to active components, 50 mm vertically alignable: $P_N < 50\%$ , 0 mm horizontally, 40 mm vertically top, 20 mm vertically bottom

#### Connection data, input

Connection method	Pluggable screw connection
Conductor cross section solid min.	0.2 mm <sup>2</sup>
Conductor cross section solid max.	2.5 mm <sup>2</sup>
Conductor cross section flexible min.	0.2 mm <sup>2</sup>
Conductor cross section flexible max.	2.5 mm <sup>2</sup>
Conductor cross section AWG min.	20
Conductor cross section AWG max.	12
Stripping length	7 mm
Screw thread	M3

## Power supply unit - QUINT-PS/1AC/24DC/ 3.5 - 2866747

### Technical data

#### Connection data, output

Connection method	Pluggable screw connection
Conductor cross section solid min.	0.2 mm <sup>2</sup>
Conductor cross section solid max.	2.5 mm <sup>2</sup>
Conductor cross section flexible min.	0.2 mm <sup>2</sup>
Conductor cross section flexible max.	2.5 mm <sup>2</sup>
Conductor cross section AWG min.	20
Conductor cross section AWG max.	12
Stripping length	7 mm
Screw thread	M3

#### Connection data for signaling

Connection method	Pluggable screw connection
Conductor cross section solid min.	0.2 mm <sup>2</sup>
Conductor cross section solid max.	2.5 mm <sup>2</sup>
Conductor cross section flexible min.	0.2 mm <sup>2</sup>
Conductor cross section flexible max.	2.5 mm <sup>2</sup>
Conductor cross section AWG min.	20
Conductor cross section AWG max.	12
Screw thread	M3

#### Standards and Regulations

Electromagnetic compatibility	Conformance with EMC Directive 2014/30/EU
Noise emission	EN 55011 (EN 55022)
Noise immunity	EN 61000-6-2:2005
Connection in acc. with standard	CSA
Standards/regulations	EN 61000-4-2
Contact discharge	4 kV (Test Level 2)
Standards/regulations	EN 61000-4-3
Frequency range	80 MHz ... 1 GHz
Test field strength	10 V/m (Test Level 3)
Frequency range	1.4 GHz ... 2 GHz
Test field strength	3 V/m (Test Level 2)
Standards/regulations	EN 61000-4-4
Comments	Criterion B
Standards/regulations	EN 61000-6-3
	EN 61000-4-6
Frequency range	0.15 MHz ... 80 MHz
Voltage	10 V (Test Level 3)
Low Voltage Directive	Conformance with LV directive 2006/95/EC
Standard - Electrical safety	IEC 60950-1/VDE 0805 (SELV)
Standard - Electronic equipment for use in electrical power installations and their assembly into electrical power installations	EN 50178/VDE 0160 (PELV)

## Power supply unit - QUINT-PS/1AC/24DC/ 3.5 - 2866747

### Technical data

#### Standards and Regulations

Standard – Safety extra-low voltage	IEC 60950-1 (SELV) and EN 60204-1 (PELV)
Standard - Safe isolation	DIN VDE 0100-410
Standard – Protection against shock currents, basic requirements for protective separation in electrical equipment	EN 50178
Standard – Limitation of mains harmonic currents	EN 61000-3-2
Standard - Equipment safety	BG (design tested)
Standard - Approval for medical use	IEC 60601-1, 2 x MOOP
Shipbuilding approval	DNV GL (EMC A), ABS, LR, RINA, NK, BV
UL approvals	UL Listed UL 508
	UL/C-UL Recognized UL 60950-1
	UL ANSI/ISA-12.12.01 Class I, Division 2, Groups A, B, C, D (Hazardous Location)
DeviceNet approval	DeviceNet™ Power Supply Conformance Tested
Shock	18 ms, 30g, in each space direction (according to IEC 60068-2-27)
Vibration (operation)	< 15 Hz, amplitude ±2.5 mm (according to IEC 60068-2-6)
	15 Hz ... 150 Hz, 2.3g, 90 min.
Approval - requirement of the semiconductor industry with regard to mains voltage dips	SEMI F47-0706 Compliance Certificate
Certificate	CB Scheme
Rail applications	EN 50121-4
Overvoltage category (EN 62477-1)	III

#### Environmental Product Compliance

REACH SVHC	Lead 7439-92-1
China RoHS	Environmentally Friendly Use Period = 25;
	For details about hazardous substances go to tab "Downloads", Category "Manufacturer's declaration"

### Drawings

# Power supply unit - QUINT-PS/1AC/24DC/ 3.5 - 2866747

Block diagram

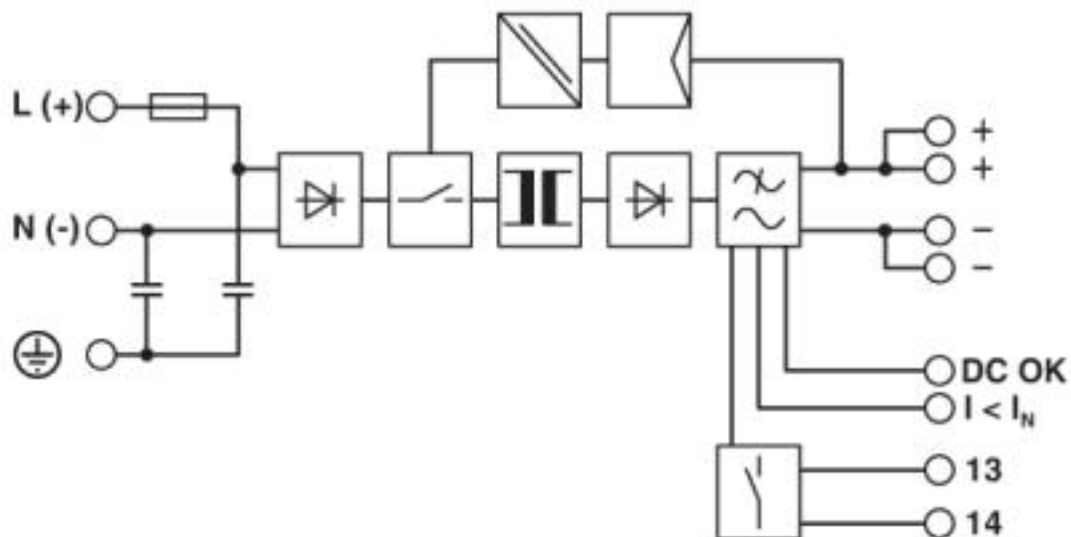

## Classifications

### eCl@ss

eCl@ss 4.0	27040700
eCl@ss 4.1	27040700
eCl@ss 5.0	27242200
eCl@ss 5.1	27242200
eCl@ss 6.0	27049000
eCl@ss 7.0	27049002
eCl@ss 8.0	27049002
eCl@ss 9.0	27040701

### ETIM

ETIM 2.0	EC001039
ETIM 3.0	EC001039
ETIM 4.0	EC000599
ETIM 5.0	EC002540
ETIM 6.0	EC002540
ETIM 7.0	EC002540

### UNSPSC

UNSPSC 6.01	30211502
UNSPSC 7.0901	39121004
UNSPSC 11	39121004
UNSPSC 12.01	39121004
UNSPSC 13.2	39121004

<https://www.phoenixcontact.com/gb/products/2866747>



## Power supply unit - QUINT-PS/1AC/24DC/ 3.5 - 2866747

### Approvals

#### Approvals







#### Approvals

DNV GL / CSA / BV / LR / NK / ABS / RINA / UL Listed / UL Recognized / cUL Recognized / IECCEB Scheme / cUL Listed / SEMI F47 / DeviceNet / EAC / EAC / cULus Recognized / cULus Listed

#### Ex Approvals









UL Listed / cUL Listed / cULus Listed

#### Approval details

DNV GL		<a href="https://approvalfinder.dnvgl.com/">https://approvalfinder.dnvgl.com/</a>	TAE000014W
CSA		<a href="http://www.csagroup.org/services-industries/product-listing/">http://www.csagroup.org/services-industries/product-listing/</a>	1897767
BV		<a href="http://www.veristar.com/portal/veristarinfo/generalinfo/approved/approvedProducts/equipmentAndMaterials">http://www.veristar.com/portal/veristarinfo/generalinfo/approved/approvedProducts/equipmentAndMaterials</a>	21004-C0 BV
LR		<a href="http://www.lr.org/en">http://www.lr.org/en</a>	08/20069 E4
NK		<a href="http://www.classnk.or.jp/hp/en/">http://www.classnk.or.jp/hp/en/</a>	08A039
ABS		<a href="http://www.eagle.org/eagleExternalPortalWEB/">http://www.eagle.org/eagleExternalPortalWEB/</a>	15-HG1375463-1-PDA
RINA		<a href="http://www.rina.org/en">http://www.rina.org/en</a>	ELE316517XG
UL Listed		<a href="http://database.ul.com/cgi-bin/XYV/template/LISEXT/1FRAME/index.htm">http://database.ul.com/cgi-bin/XYV/template/LISEXT/1FRAME/index.htm</a>	FILE E 123528

## Power supply unit - QUINT-PS/1AC/24DC/ 3.5 - 2866747

### Approvals

UL Recognized		<a href="http://database.ul.com/cgi-bin/XYV/template/LISEXT/1FRAME/index.htm">http://database.ul.com/cgi-bin/XYV/template/LISEXT/1FRAME/index.htm</a>	FILE E 211944
cUL Recognized		<a href="http://database.ul.com/cgi-bin/XYV/template/LISEXT/1FRAME/index.htm">http://database.ul.com/cgi-bin/XYV/template/LISEXT/1FRAME/index.htm</a>	FILE E 211944
IECEE CB Scheme		<a href="http://www.iecee.org/">http://www.iecee.org/</a>	SI-1865 A2
cUL Listed		<a href="http://database.ul.com/cgi-bin/XYV/template/LISEXT/1FRAME/index.htm">http://database.ul.com/cgi-bin/XYV/template/LISEXT/1FRAME/index.htm</a>	FILE E 123528
SEMI F47			SEMI F47
DeviceNet		<a href="http://www.odva.org">http://www.odva.org</a>	10824/06.01.2010
EAC			EAC-Zulassung
EAC			RU C- DE.A*30.B.01082
cULus Recognized			
cULus Listed			



# SCATTERGOOD & JOHNSON LTD

ELECTRICAL ENGINEERING & FLUID CONTROL DISTRIBUTORS

Est.1899

At Scattergood & Johnson Ltd, we pride ourselves on being a technical distributor to specialist industries.

Working with a range of quality product suppliers across a number of specialist markets, we are not your average 'box shifter' - we are your technical and supply chain partner.

We fully support every product we sell - for free! Our internal team and external sales engineers can answer any product or application question, no matter the complexity.

Backing up this technical ability is a range of 50,000+ products available from stock for nationwide next day delivery (same day if required!), or you can collect what you need from any of our trade counters around the UK.

Select your specialist interest below to learn more about how we can help.



Online, In Branch and On the Road - Scattergood & Johnson Ltd, there when you need us.

# [www.scatts.co.uk](http://www.scatts.co.uk)