

MCR-C-...-DC

MCR 3-Way Isolation Amplifier

INTERFACE

Data Sheet

© PHOENIX CONTACT - 12/2005



Description

MCR 3-way isolation amplifiers are used to electrically isolate and convert analog signals.

The blocks provide electrical isolation of analog standard signals. The module input and output are supplied via integrated DC/DC converters, which are electrically isolated from the mains (3-way isolation, see Figure 1).

The MCR modules ensure the safe decoupling of a sensor circuit from the evaluation circuit and also prevent the negative effects of several sensor circuits connected with one another. 3-way isolation enables the universal use of modules both locally and close to the control system for signal conversion and electrical isolation as well as on the transmission path for jumpering high load resistors.

Method of Operation

The analog signal is first modulated and then electrically isolated using a transformer.

The electrically isolated signal is then provided at the output, demodulated, filtered, and amplified.

The space-saving 12.5 mm wide ME housing, with plug-in connection technology, enables the 20 V DC ... 30 V DC supply to be quickly looped through using pre-assembled wire jumpers.

MCR 3-way isolation amplifiers can be snapped onto symmetrical DIN rails according to EN 60715.

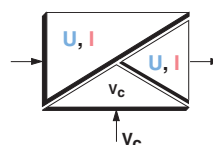

Figure 1 3-way isolation



Make sure you always use the latest documentation.
It can be downloaded at www.download.phoenixcontact.com.

A conversion table is available on the Internet at
http://www.download.phoenixcontact.com/general/7000_en_00.pdf.



This data sheet is valid for all products listed on the following page:

Ordering Data

Description	Type	Order No.	Pcs./Pkt.
MCR 3-way isolation amplifier, for electrical isolation of analog signals, input signal: 0 V ... 10 V, output signal: 0 mA ... 20 mA	MCR-C-U-I-0-DC	28 14 47 2	5
MCR 3-way isolation amplifier, for electrical isolation of analog signals, input signal: 0(4) mA ... 20 mA, output signal: 0(4) mA ... 20 mA	MCR-C-I-I-00-DC	28 14 50 8	5
MCR 3-way isolation amplifier, for electrical isolation of analog signals, input signal: 0 mA ... 20 mA/(±)20 mA, output signal: 0 V ... 10 V/(±)10 V	MCR-C-I-U-0-DC	28 14 49 8	5
MCR 3-way isolation amplifier, for electrical isolation of analog signals, input signal: 0 V ... 10 V/(±)10 V, output signal: 0 V ... 10 V/(±)10 V	MCR-C-U-U-DC	28 14 46 9	5
MCR 3-way isolation amplifier, for electrical isolation of analog signals, input signal: 4 mA ... 20 mA, output signal: 0 V ... 10 V	MCR-C-I-U-4-DC	28 14 51 1	5
MCR 3-way isolation amplifier, for electrical isolation of analog signals, input signal: 0 V ... 10 V, output signal: 4 mA ... 20 mA	MCR-C-U-I-4-DC	28 14 53 7	5
MCR 3-way isolation amplifier, for electrical isolation of analog signals, input signal: 0 mA ... 20 mA, output signal: 4 mA ... 20 mA	MCR-C-I-I-04-DC	28 14 54 0	5
MCR 3-way isolation amplifier, for electrical isolation of analog signals, input signal: 4 mA ... 20 mA, output signal: 0 mA ... 20 mA	MCR-C-I-I-40-DC	28 14 52 4	5

Technical Data

Input (Measuring Input)

Input signal	
MCR-C-U-I-0-DC MCR-C-I-I-00-DC	0 V ... 10 V 0(4) mA ... 20 mA
MCR-C-I-U-0-DC MCR-C-U-U-DC	0 mA ... 20 mA/(±)20 mA 0 V ... 10 V/(±)10 V
MCR-C-I-U-4-DC MCR-C-U-I-4-DC	4 mA ... 20 mA 0 V ... 10 V
MCR-C-I-I-04-DC MCR-C-I-I-40-DC	0 mA ... 20 mA 4 mA ... 20 mA
Input resistance	
MCR-C-U-I-0-DC MCR-C-I-I-00-DC	200 kΩ 50 Ω
MCR-C-I-U-0-DC MCR-C-U-U-DC	50 Ω 100 kΩ
MCR-C-I-U-4-DC MCR-C-U-I-4-DC	50 Ω 100 kΩ
MCR-C-I-I-04-DC MCR-C-I-I-40-DC	50 Ω 50 Ω



Output (Measuring Output)

Output signal	
MCR-C-U-I-0-DC MCR-C-I-I-00-DC	0 mA ... 20 mA 0(4) mA ... 20 mA
MCR-C-I-U-0-DC MCR-C-U-U-DC	0 V ... 10 V/(±)10 V 0 V ... 10 V/(±)10 V
MCR-C-I-U-4-DC MCR-C-U-I-4-DC	0 V ... 10 V 4 mA ... 20 mA
MCR-C-I-I-04-DC MCR-C-I-I-40-DC	4 mA ... 20 mA 0 mA ... 20 mA
Load	
MCR-C-U-I-0-DC MCR-C-I-I-00-DC	< 500 Ω < 500 Ω
MCR-C-I-U-0-DC MCR-C-U-U-DC	> 10 kΩ > 10 kΩ
MCR-C-I-U-4-DC MCR-C-U-I-4-DC	> 10 kΩ < 500 Ω

Output (Measuring Output) (Continued)

MCR-C-I-I-04-DC	< 500 Ω
MCR-C-I-I-40-DC	< 500 Ω
Linear transmission range (in reference to the final value)	
MCR-C-U-I-0-DC	-5% ... 105%
MCR-C-I-I-00-DC	0% ... 105%
MCR-C-I-U-0-DC	-110% ... 110%
MCR-C-U-U-DC	-110% ... 110%
MCR-C-I-U-4-DC	-10% ... 110%
MCR-C-U-I-4-DC	-5% ... 105%
MCR-C-I-I-04-DC	-5% ... 105%
MCR-C-I-I-40-DC	-5% ... 105%

General Data

Supply voltage	20 V DC ... 30 V DC
Operating current (without load current)	< 15 mA
Transmission error	
MCR-C-U-I-0-DC	< 0.2% of final value
MCR-C-I-I-00-DC	< 0.2% of final value
MCR-C-I-U-0-DC	< 0.2% of final value
MCR-C-U-U-DC	< 0.2% of final value
MCR-C-I-U-4-DC	< 0.3% of final value
MCR-C-U-I-4-DC	< 0.3% of final value
MCR-C-I-I-04-DC	< 0.3% of final value
MCR-C-I-I-40-DC	< 0.3% of final value
Temperature coefficient	< 0.015%/K
Limit frequency (3 dB)	30 Hz, approximately
Test voltage	
Input/output	1 kV AC/50 Hz/1 min.
Input/supply	1 kV AC/50 Hz/1 min.
Output/supply	1 kV AC/50 Hz/1 min.
Ambient operating temperature range	-25°C ... 60°C
Approvals	 
Connection type	Screw/plug-in connection
Mounting position	Any
Assembly	Any

Conformance With EMC Directive 89/336/EEC and Low Voltage Directive 73/23/EEC**Noise Immunity Test According to EN 61000-6-2¹**

Electrostatic discharge (ESD)	EN 61000-4-2	Criterion B ² 8 kV air discharge
Electromagnetic HF field Amplitude modulation Pulse modulation	EN 61000-4-3	Criterion A ³ 10 V/m 10 V/m
Fast transients (burst)	EN 61000-4-4	Criterion B ² I/O/S ⁴ : 2 kV/5 kHz
Surge current load (surge)	EN 61000-4-5	Criterion B ² V ⁴ : 0.5 kV/2 Ω
Conducted interference	EN 61000-4-6	Criterion A ³ I/O/S ⁴ : 10 V

Noise Emission Test According to EN 61000-6-4

Noise emission of housing	EN 55011 ⁵	Class A ⁶
---------------------------	-----------------------	----------------------

¹ EN 61000 corresponds to IEC 61000

² Criterion B: Temporary adverse effects on the operating behavior, which the device corrects automatically.

³ Criterion A: Normal operating characteristics within the specified limits.

⁴ I ≙ Input/O ≙ Output/S ≙ Supply

⁵ EN 55011 corresponds to CISPR11

⁶ Class A: Industrial application, without special installation measures.

Dimensions

Figure 2 Dimensions (in mm)

Structure

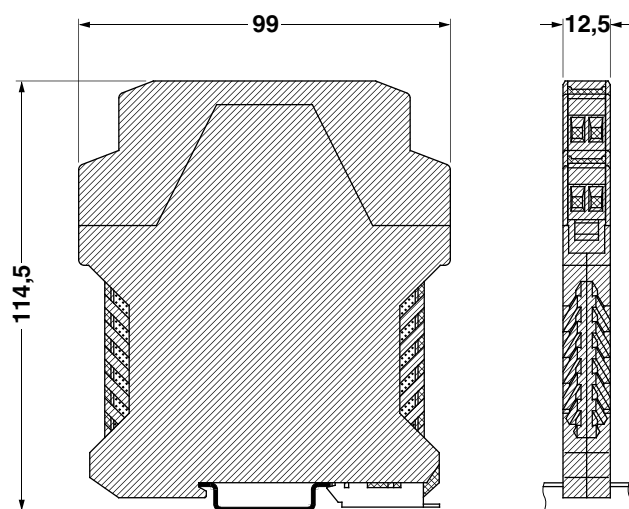
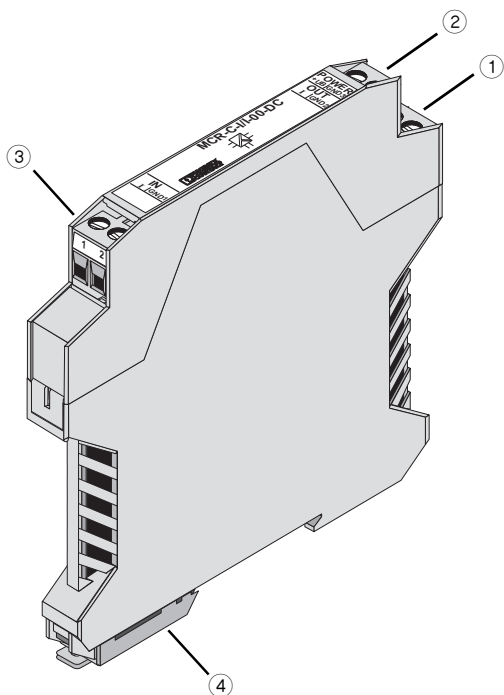

Figure 3 Structure

- 1 Supply voltage
- 2 Signal output
- 3 Signal input
- 4 Metal lock for fastening on the DIN rail

Block Diagram

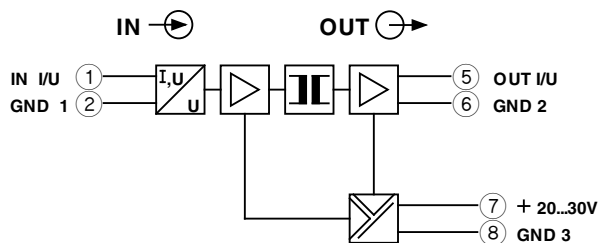

Figure 5 Block diagram

© PHOENIX CONTACT 12/2005

Transmission Characteristic Curve

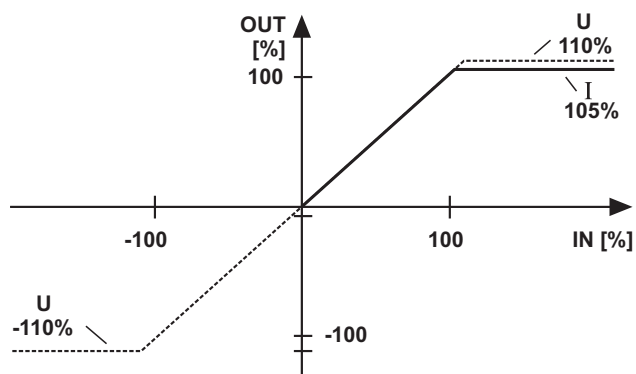

Figure 4 Transmission characteristic curve



SCATTERGOOD & JOHNSON LTD

ELECTRICAL ENGINEERING & FLUID CONTROL DISTRIBUTORS

Est.1899

At Scattergood & Johnson Ltd, we pride ourselves on being a technical distributor to specialist industries.

Working with a range of quality product suppliers across a number of specialist markets, we are not your average 'box shifter' - we are your technical and supply chain partner.

We fully support every product we sell - for free! Our internal team and external sales engineers can answer any product or application question, no matter the complexity.

Backing up this technical ability is a range of 50,000+ products available from stock for nationwide next day delivery (same day if required!), or you can collect what you need from any of our trade counters around the UK.

Select your specialist interest below to learn more about how we can help.



Online, In Branch and On the Road - Scattergood & Johnson Ltd, there when you need us.

www.scatts.co.uk