

Monitoring relay - EMD-FL-3V-400 - 2866064

Please be informed that the data shown in this PDF Document is generated from our Online Catalog. Please find the complete data in the user's documentation. Our General Terms of Use for Downloads are valid (<http://phoenixcontact.com/download>)



Monitoring relay for monitoring 3-phase voltages of 280...520 V AC, undervoltage, window, phase sequence, phase failure, asymmetry, wide-range power supply unit, 2 PDTs

Product Description

Increasingly higher demands are being placed on safety and system availability - across all sectors. Processes are becoming more and more complex, not only in mechanical engineering and the chemical industry, but also in plant and automation technology. Demands on power engineering are also increasing constantly.

Error-free and therefore cost-effective operation can only be achieved through continuous monitoring of important network and system parameters. Electronic monitoring relays in the EMD series are available for a wide range of monitoring tasks to avoid the consequences of errors or to keep them within limits.

The operating states are indicated using colored LEDs, errors that may occur can be sent to a control system via a floating contact or can shut down a part of the system. Some device versions are equipped with startup and response delays in order to briefly tolerate measured values outside the set monitoring range.

Your advantages

- Adjustable via potentiometer on the front
- Variable supply voltage range
- Adjustable asymmetry
- Adjustable response delay



Key Commercial Data

Packing unit	1 pc
GTIN	 4 017918 975029
GTIN	4017918975029
Weight per Piece (excluding packing)	176.800 g
Custom tariff number	85364900
Country of origin	Austria

Monitoring relay - EMD-FL-3V-400 - 2866064

Technical data

Note

Utilization restriction	EMC: class A product, see manufacturer's declaration in the download area
-------------------------	---

Dimensions

Width	22.5 mm
Height	90 mm
Depth	113 mm

Ambient conditions

Ambient temperature (operation)	-25 °C ... 55 °C
	-25 °C ... 40 °C (corresponds to UL 508)
Ambient temperature (storage/transport)	-25 °C ... 70 °C
Permissible humidity (operation)	15 % ... 85 %
Degree of protection	IP40 (Housing)
	IP20 (Connection terminal blocks)
Noise immunity	EN 61000-6-2

Input data

Nominal input voltage U_N	3 N ~ 400/230 V
Maximum temperature coefficient	< 0.1 %/K
Function	Undervoltage, window, asymmetry, phase sequence, phase failure
Min. setting range	-30 % ... 20 % (From U_N)
Max. setting range	-20 % ... 30 % (From U_N)
Min setting range of the voltage threshold value	280 V AC ... 480 V AC
Max. setting range of the voltage threshold value	320 V AC ... 520 V AC
Setting range for response delay	0.1 s ... 10 s
Basic accuracy	± 5 % (of scale end value)
Setting accuracy	≤ 5 % (of scale end value)
Repeat accuracy	≤ 2 %
Asymmetry	5 % ... 25% / OFF
Recovery time	500 ms

Contact side

Contact type	2 floating PDT contacts
Maximum switching voltage	250 V AC (in acc. with IEC 60664-1)
Interrupting rating (ohmic load) max.	750 VA (3 A/250 V AC, module aligned, ≤ 5 mm spacing)
	1250 VA (5 A/250 V AC, module not aligned, ≥ 5 mm spacing)
Output fuse	5 A (fast-blow)

Power supply

Monitoring relay - EMD-FL-3V-400 - 2866064

Technical data

Power supply

Supply voltage	230 V AC
	24 V DC
Supply voltage range	24 V AC ... 240 V AC -15 % ... +10 %
	24 V DC ... 240 V DC -20 % ... +25 %

General

Mechanical service life	approx. 2×10^7 cycles
Operating mode	100% operating factor
Mounting position	any
Assembly instructions	on standard DIN rail NS 35 in accordance with EN 60715
Electromagnetic compatibility	Conformance with EMC directive
Housing insulation material	Polyamide PA, self-extinguishing
Color	green

Connection data

Connection method	Screw connection
Stripping length	8 mm
Conductor cross section solid	0.5 mm ² ... 2.5 mm ²
Conductor cross section flexible	0.25 mm ² ... 2.5 mm ²
Conductor cross section AWG	20 ... 14
Tightening torque	1 Nm

Standards and Regulations

Electromagnetic compatibility	Conformance with EMC directive
Noise emission	EN 61000-6-4
Noise immunity	EN 61000-6-2
Standards/regulations	EN 50178
Rated insulation voltage	300 V
Insulation	Basic insulation
Pollution degree	2
Overvoltage category	III
Low Voltage Directive	Conformance with Low Voltage Directive

Environmental Product Compliance

China RoHS	Environmentally friendly use period: unlimited = EFUP-e
	No hazardous substances above threshold values

Drawings

Monitoring relay - EMD-FL-3V-400 - 2866064

Connection diagram

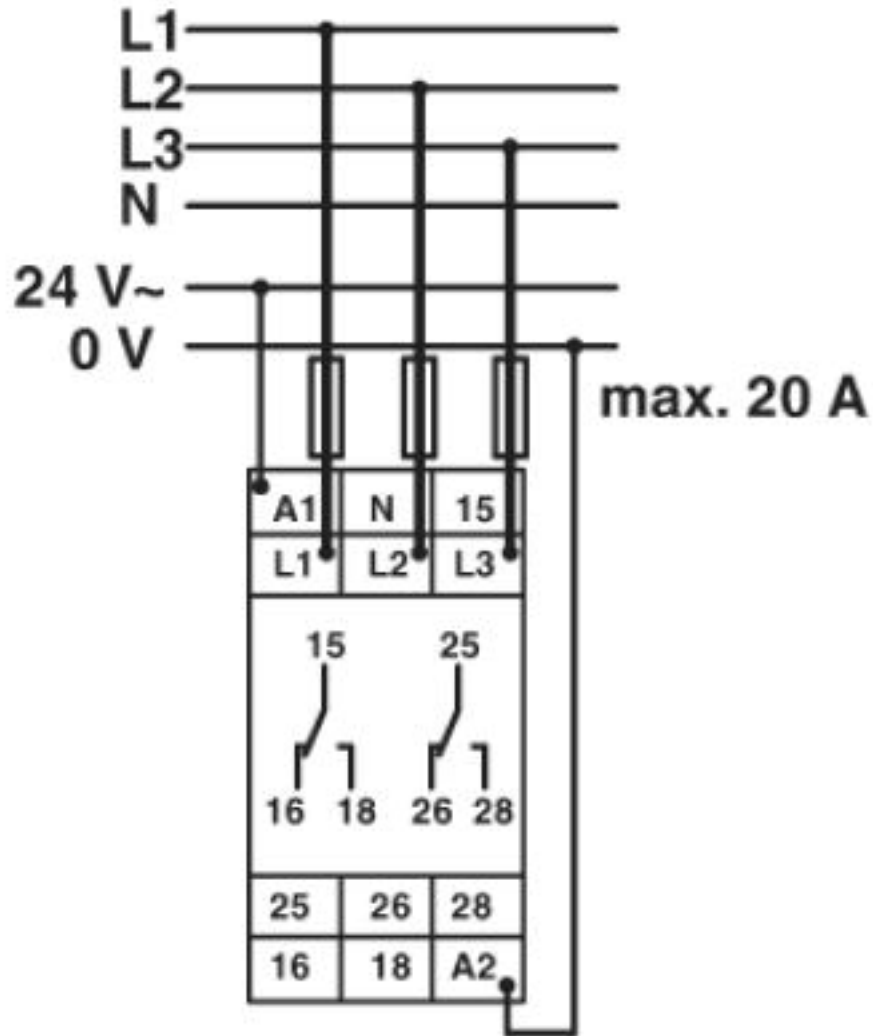

Monitoring relay - EMD-FL-3V-400 - 2866064

Application drawing

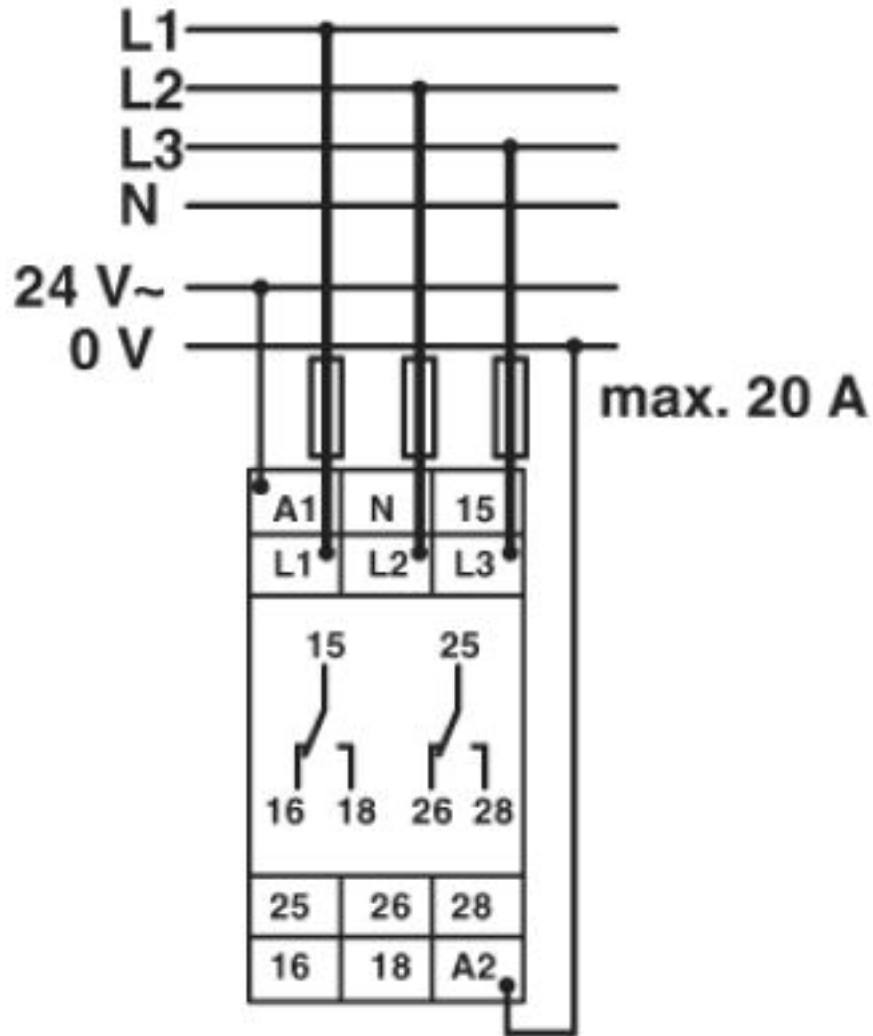

Connection example

Monitoring relay - EMD-FL-3V-400 - 2866064

Block diagram

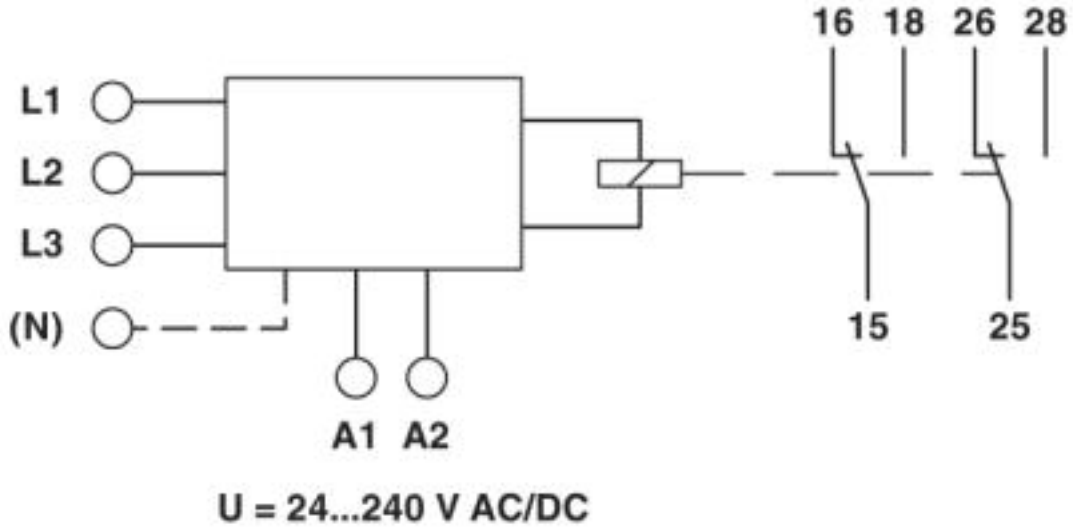

Classifications

eCl@ss

eCl@ss 4.0	27371100
eCl@ss 4.1	27371100
eCl@ss 5.0	27371800
eCl@ss 5.1	27371800
eCl@ss 6.0	27371800
eCl@ss 7.0	27371801
eCl@ss 8.0	27371801
eCl@ss 9.0	27371801

ETIM

ETIM 2.0	EC001438
ETIM 3.0	EC001438
ETIM 4.0	EC001438
ETIM 5.0	EC001438
ETIM 6.0	EC001438
ETIM 7.0	EC001438

UNSPSC

UNSPSC 6.01	30211916
UNSPSC 7.0901	39121535
UNSPSC 11	39121535

<https://www.phoenixcontact.com/us/products/2866064>



Monitoring relay - EMD-FL-3V-400 - 2866064

Classifications

UNSPSC

UNSPSC 12.01	39121535
UNSPSC 13.2	41113620

Approvals

Approvals

Approvals

UL Listed / cUL Listed / EAC / EAC / cULus Listed

Ex Approvals

Approval details

UL Listed		http://database.ul.com/cgi-bin/XYV/template/LISEXT/1FRAME/index.htm	FILE E 172140
-----------	---	---	---------------

cUL Listed		http://database.ul.com/cgi-bin/XYV/template/LISEXT/1FRAME/index.htm	FILE E 172140
------------	---	---	---------------

EAC			TR_TS_D_00573_c
-----	---	--	-----------------

EAC			TR_TS_S_00010_c
-----	---	--	-----------------

cULus Listed			
--------------	---	--	--

Phoenix Contact 2019 © - all rights reserved
<http://www.phoenixcontact.com>



SCATTERGOOD & JOHNSON LTD

ELECTRICAL ENGINEERING & FLUID CONTROL DISTRIBUTORS

Est.1899

At Scattergood & Johnson Ltd, we pride ourselves on being a technical distributor to specialist industries.

Working with a range of quality product suppliers across a number of specialist markets, we are not your average 'box shifter' - we are your technical and supply chain partner.

We fully support every product we sell - for free! Our internal team and external sales engineers can answer any product or application question, no matter the complexity.

Backing up this technical ability is a range of 50,000+ products available from stock for nationwide next day delivery (same day if required!), or you can collect what you need from any of our trade counters around the UK.

Select your specialist interest below to learn more about how we can help.



Online, In Branch and On the Road - Scattergood & Johnson Ltd, there when you need us.

www.scatts.co.uk