



Energy and current measuring technology

Converting, measuring, and monitoring



Energy and current measuring technology – converting, measuring, and monitoring

Reduce costs, increase efficiency:

Systematic energy management is an ideal tool for continuously increasing energy efficiency in companies and organizations.

Identify potential cost savings for the cost-effective and environmentally-friendly operation of your machines and systems.

Phoenix Contact offers professional products for energy and power measurement.

Current transformers

PACT current transformers offer a complete product range for converting alternating currents up to 4000 A into secondary currents of 1 A and 5 A.



Energy meters

EMpro energy meters acquire and monitor the characteristic electrical data of your machines and systems centrally and on site.

Current transformers for retrofitting

PACT RCP current transformers for retrofitting can be conveniently installed where there is not enough space for split core current transformers.

Sensors and meters

Keep an eye on the flow rates of water and compressed air in your system and reduce costs as a result.

Advantages of energy management

Continuously recorded energy flow provides the basis for a target-oriented operational energy management system.

Reduce energy costs

By identifying potential energy savings.

Optimize system capacity

Through intelligent switching of system parts, uniform network load, and reduced harmonics.

Reduce peak loads

With intelligent trend calculation and load management.

Safeguard production processes and minimize downtimes

By continuously monitoring system parameters.



Software for energy and power measurement

Acquire energy data for heat, cold, air or electricity and efficiently manage the use of these resources in your machines and systems.



Current and voltage measuring technology

You can use MCR current and voltage transducers to convert currents and voltages of all waveforms into standard analog signals.

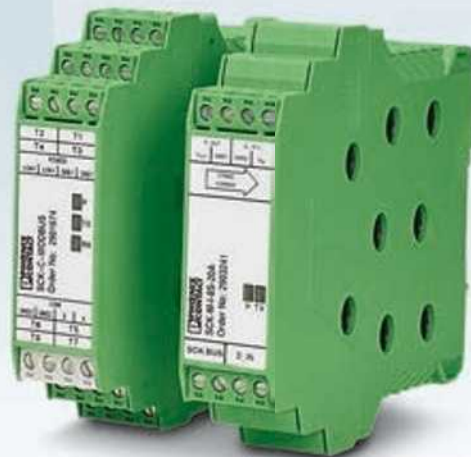

PV string monitoring

SOLARCHECK provides reliable information regarding the performance of your photovoltaic system. You can therefore detect errors and take appropriate countermeasures.

Table of contents

Energy meters

Pages 04 – 07

Current transformers for retrofitting

Pages 08 – 09

Plug-in and winding current transformers

Pages 10 – 17

Sensors and meters

Pages 18 – 19

Software for energy and power measurement

Pages 20 – 21

Current transducers for direct and alternating currents

Pages 22 – 23

Current transducers for alternating currents

Pages 24 – 25

PV string monitoring

Pages 26 – 29

Voltage transducers

Page 30

Basics of current acquisition

Page 31

EMpro energy meters – for your energy management

EMpro energy meters acquire and monitor the characteristic electrical data of your machines and systems. Using network-capable devices ensures that all measuring data is available centrally and on site.

With EMpro, you can be confident you have the right measuring device solution for your energy management.

Ethernet

RS 485

PROFI
BUS

Modbus

Your advantages:

- Direct access to measured values – at the touch of a button on the device or remotely from the host computer
- User-friendly configuration – on site by following the operator guidance or via the integrated web server
- Easy integration into network structures, thanks to flexible connection options
- High degree of planning reliability and investment security, thanks to expansion with additional special function modules and communication modules



The communication expert

EMpro MA600

- Performs measuring tasks in power supply applications up to 700 V AC
- Can be extended with communication modules and special function modules
- Remote access via web server

Monitoring web server

Remote access to multiple meters – with just one IP address

The web server that has been integrated into the Ethernet communication modules allows you to conveniently configure key parameters online. It also allows remote access to key electrical characteristics such as current, voltage, power, energy, and harmonics.

In your monitoring network, the master consists of an EMpro MA600 meter, combined with an Ethernet gateway. You can conveniently integrate the lower-level energy meters as slaves via the web server interface. You can therefore access all energy data with just one IP address.



The universal solution on the front panel

EMpro MA400

- Performs standard measuring tasks up to 500 V AC
- Can be extended with RS-485 module and pulse module



The compact DIN rail solution

EMpro MA250

- Performs measuring tasks in small control cabinets directly on the machine
- Integrated RS-485 interface

Monitoring energy flow and logging energy data

Use network-capable EMpro meters to monitor characteristic electrical data centrally and on site. The modular controller gathers all relevant energy characteristics of the production processes and logs these in an SQL database.

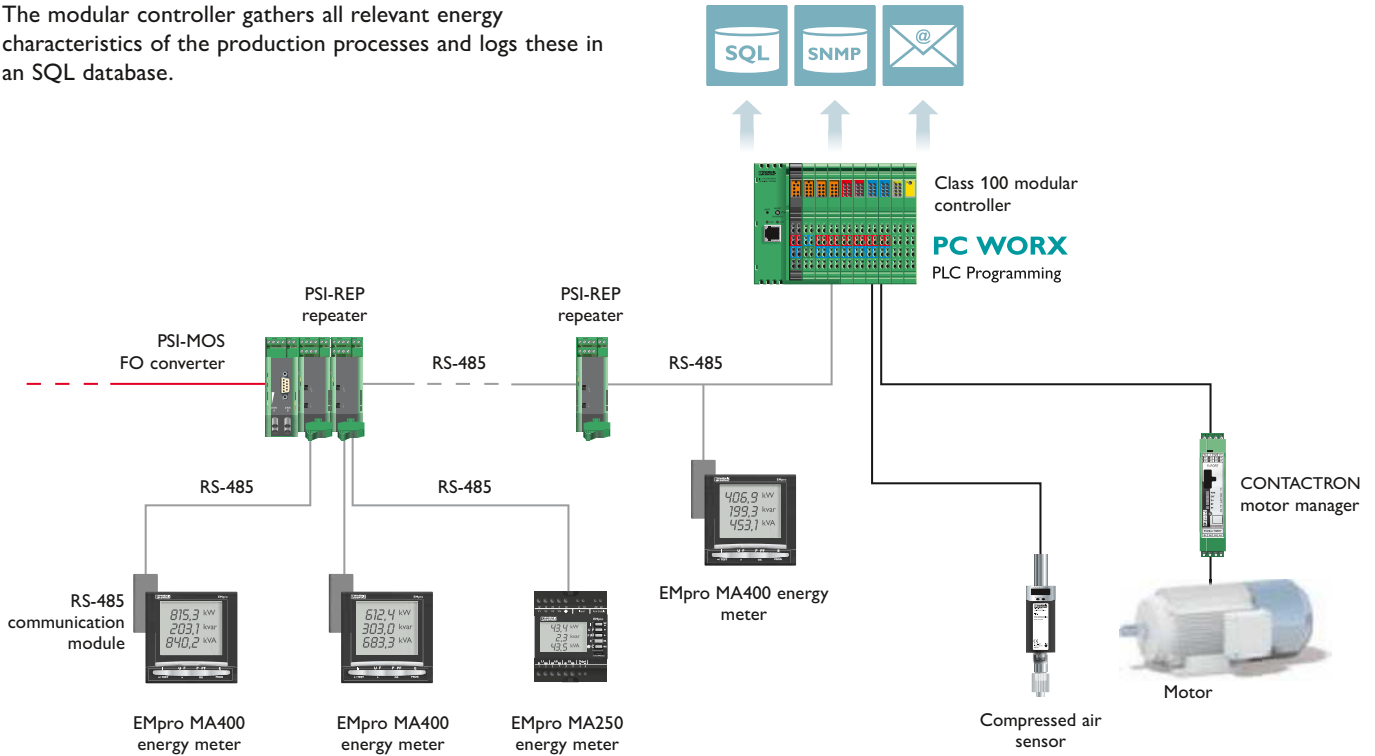

Repeaters

PSI repeaters increase the performance and availability of bus systems.

- Increased range and number of devices
- Individual network structures
- 4-way electrical isolation
- Can be combined with PSI-MOS FO converters



FO converters

PSI-MOS FO converters contribute to interference-free data transmission in serial Ethernet and fieldbus applications.

- Fiber optic connections of up to 45 km
- Individual network structures
- High-grade electrical isolation
- Can be combined with PSI-MOS repeaters



Software for data logging

Turn your controller into a data logger. The SD FLASH 512MB ILDLIC FLEX memory card from Phoenix Contact provides all the software needed to extend your PLC for use as a data logger. The software contains the familiar application from the FLEX data logger kit. In conjunction with an ILC 151 GSM/GPRS modular controller, 3 digital and 4 analog input or output terminal blocks can be mounted.

Product overview: EMpro energy meters

The DIN rail adapter enables EMpro MA600 and EMpro MA400 built-in devices to also be mounted on the DIN rail.

Order No.: 2902078
Type: EEM-MKT-DRA



EMpro MA600

EMpro MA400

EMpro MA250

EMpro MA200

Type	EMpro MA600	EEM-MA400	EEM-MA250	EEM-MA200
Order No.	2901366	2901364	2901363	2901362
Type	EMpro MA600-24DC			
Order No.	2902352			

Measurement					
Currents	I1, I2, I3, ΣI	●			
	I1, I2, I3, IN (calculation)	●	●	●	●
	Maximum values	●	●	●	●
	Mean values	●			
	Current measurement	Direct/ via current transformer	Via current transformer	Via current transformer	Via current transformer
Voltages	U12, U23, U31, V1, V2, V3	●	●	●	●
	Maximum values, mean values	●			
	Voltage measurement via voltage transducer	●			
	Voltage measurement, direct (AC)	Up to 700 V	Up to 500 V	Up to 500 V	Up to 500 V
Frequency	F	●	●	●	●
Power	ΣP, ΣQ, ΣS (+/-)	●	●	●	●
	P, Q, S per phase (+/-)	●	●	●	●
	Maximum values P, Q, S	●	●	●	●
	Mean values P, Q, S	●			
	Trend power	●			
Power factor	ΣPF; PF per phase	●	●	●	●
Metering	Real energy/reactive energy	kWh +/- / kvarh +/-	kWh + / kvarh +	kWh + / kvarh +	kWh + / kvarh +
	2-tariff meter			●	●
	Operating hours	●	●	●	●
Harmonics	THD I/U in %	Up to 63rd harmonic	Up to 51st harmonic	Up to 51st harmonic	Up to 51st harmonic
	Harmonics analysis	Up to 63rd harmonic			
Outputs	1 config. pulse/alarm output			●	●
Inputs	1 configurable input			●	●

Communication modules (optional)				
RS-485 JBUS/MODBUS	EEM-RS485-MA600 2901367	EEM-RS485-MA400 2901365	Integrated RS-485 interface	
PROFIBUS 1.5 Mbps	EEM-PB-MA600 2901368			
PROFIBUS 12 Mbps	EEM-PB12-MA600 2901418			
Ethernet with integrated web server	EEM-ETH-MA600 2901373			
RS-485/Ethernet gateway with integrated web server	EEM-ETH-RS485-MA600 2901374			

Special function modules (optional)				
Memory (512 kB)	EEM-MEMO-MA600 2901370			
2 digital inputs/outputs	EEM-2DIO-MA600 2901371			
2 analog outputs	EEM-2AO-MA600 2901475			
Temperature module	EEM-TEMP-MA600 2901949			
2 pulse outputs	EEM-IMP-MA600 2904313			
1 pulse output or one threshold value		EEM-IMP-MA400 2904314		

Current transformers for retrofitting – fast installation in a confined space

PACT RCP current transformers for retrofitting can be conveniently mounted where there is not enough space for split core current transformers. Acquire alternating currents up to 4000 A with the universal current measuring system. Benefit from fast installation that does not require you to remove system parts.



In a confined space

The compact Rogowski coil can also be installed conveniently where the gap between the power rails is relatively small.



Your advantages:

- High system availability due to easy installation without removing system parts
- Transform alternating currents up to 4000 A using a single measuring system
- Space saving and handy, as the current strength does not affect the size and weight
- Safe installation and operation: no dangerous open circuit voltages
- Harmonics and transients detected with phase accuracy with a large frequency range from 10 to 5000 Hz
- Secured on power rails and circular conductors, thanks to professional fixing

Fast installation

Simply place the handy Rogowski coil quickly around power rails and circular conductors.

Product overview: PACT RCP current transformers for retrofitting

Current transformer for retrofitting

Set consists of Rogowski coil and measuring transducer



Rogowski coil and measuring transducer
(1 A output signal)



Holder for power rails
(suitable for all coil lengths)

Length of measuring coil: 300 mm	Order No.	PACT RCP-4000A-1A-D95	2904921	PACT RCP-CLAMP	2904895
Length of measuring coil: 450 mm	Order No.	PACT RCP-4000A-1A-D140	2904922		
Length of measuring coil: 600 mm	Order No.	PACT RCP-4000A-1A-D190	2904923		

Technical data for measuring coil

Frequency range	10 Hz ... 5000 Hz
Position error	< 1% (the measuring coil is at a right angle to the live connector)
Rated insulation voltage	1000 V AC (rms CAT III); 600 V AC (rms CAT IV)
Ambient temperature (operation)/(storage/transport)	-30°C ... +80°C/-40°C ... +90°C

Technical data for measuring transducer

Measuring ranges (current) via DIP switch	0 ... 100 A, 250 A, 400 A, 630 A, 1000 A, 1500 A, 2000 A, 4000 A
Output signal, current	1 A AC (effective at sine)
Nominal supply voltage range	19.2 V DC ... 30 V DC
Maximum transmission error	≤ 0.5% (of final range value)
Frequency range	45 Hz ... 65 Hz
Ambient temperature (storage/transport)	-20°C ... +70°C/-25°C ... +85°C

Application examples for retrofitting current measuring technology

Standard signal generation

The current transformer converts the input current down to 1 A. For example, a downstream current transducer generates a 4 ... 20 mA signal from this secondary current for further processing.

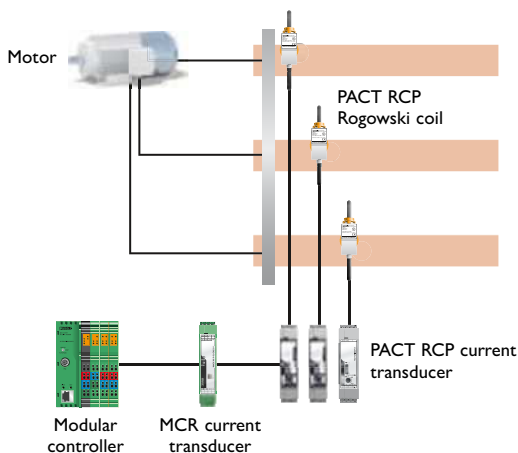

Central energy data acquisition

Downstream EMpro energy meters can be used to acquire and display characteristic data directly in the control cabinet and then forward it to your control system.

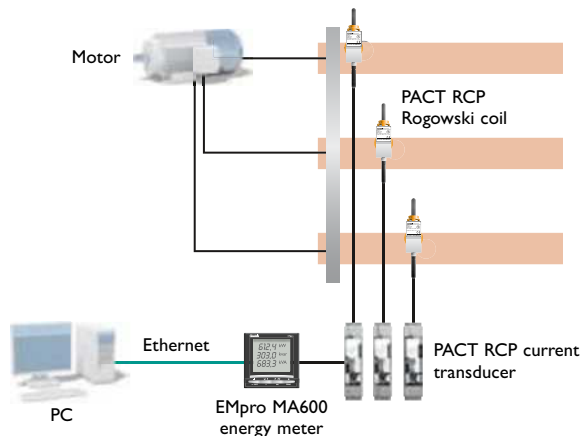

Plug-in and winding current transformers – extremely versatile

PACT current transformers offer a complete product range for converting alternating currents up to 4000 A into secondary currents of 1 A and 5 A. Depending on requirements, bus-bar, plug-in, and winding current transformers are available.

PACT current transformers are available in different transformation ratios, accuracy classes, and rated power values – in 3300 versions, for your current measurement requirements.

Your advantages:

- Considerable time savings, thanks to tool-free mounting with the transformer quick-action mechanism
- Extra safety – safe isolation according to EN 50178
- Variable mounting, thanks to flexible fixing options
- Detect peak loads reliably with a thermal nominal continuous current that is 120% of the primary rated current

Saves space and time

The tool-free transformer quick-action mechanism ensures secure and precise positioning. You can even mount the transformer in areas where a screwdriver does not fit.

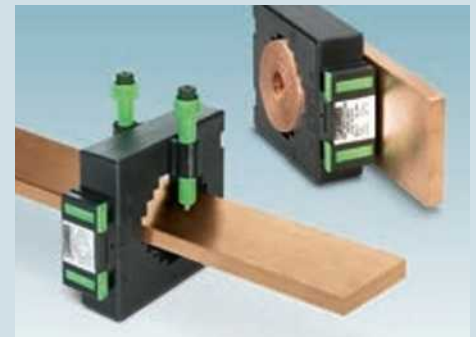

Variable and space-saving mounting

You can install PACT current transformers vertically or horizontally. If you are short of space, simply mount the transformer horizontally on the power rail. This saves space – for example when measuring branch outlets of the main supplying rail.



Extra safety across the entire system application

Safe isolation according to EN 50178

PACT current transformers offer safe isolation according to standard EN 50178. This is relevant for “electronic equipment for use in power installations”.

EN 50178 differs considerably from EN 60044, the usual standard for transformers, with regard to safety:

- Greater air and creepage distances
- Higher test voltage

PACT current transformers ensure that:

- No sparkover can occur on the secondary side of the transformer
- Human life is protected inside and outside the control cabinet

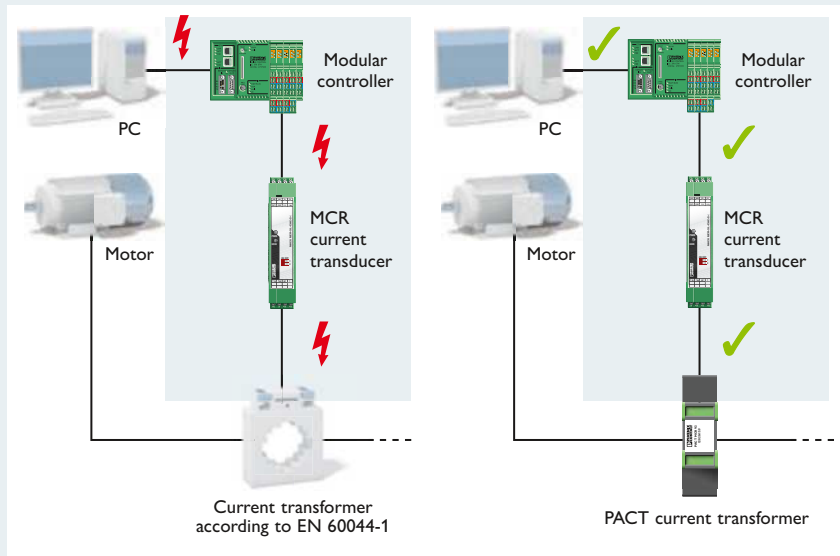

Operating voltage comparison

	EN 60044-1 (transformer standard)	EN 50178 (for power installations)
Rated insulation voltages (operating voltage)	480 V (L-L)	277 V (L-N)
	720 V (L-L)	416 V (L-N)
	1000 V (L-L)	577 V (L-N)
	–	1000 V (L-N) PACT
Impulse withstand voltage for transformer testing		
	– At 277 V (L-N)	3 kV
	– At 1000 V (L-N)	6 kV
		12 kV PACT

EN 50178 prescribes significantly higher impulse withstand voltages for transformer testing. When testing according to EN 60044, these requirements are no longer met from a rated insulation voltage of 480 V (L-L) upwards.

PACT current transformers have significantly greater air and creepage distances and are individually tested with 12 kV. This ensures increased safety.

In EN 50178, the specified voltage relates to the phase/neutral conductor, which means that in this case the rated insulation voltage of a typical 720 V transformer is only 416 V (L-N). In system applications, PACT current transformers even support use up to 1000 V (L-N).

Safe detection of current peaks

PACT current transformers can be used to safely detect current peaks greater than the rated nominal current strength without resulting in any damage. This is due to the fact that the current transformers are designed for a continuous nominal current that is 120% of the primary rated current strength.

This means that for a rated current that is 1.2 times greater, a PACT current transformer with a specified rated power of 10 VA does indeed deliver 14.4 VA – and on a continual basis.

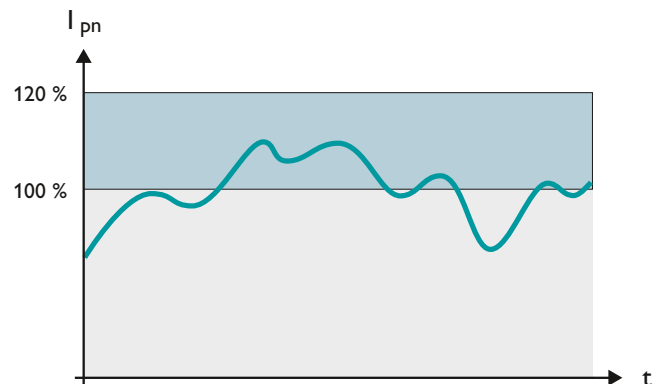

PACT current transformers also safely detect higher current peaks.

Examples of use for PACT current transformers

Standard signal generation

The PACT current transformer transforms the input current into 1 A AC or 5 A AC. For example, a downstream current transducer generates a 4 ... 20 mA signal from this secondary current for further processing.

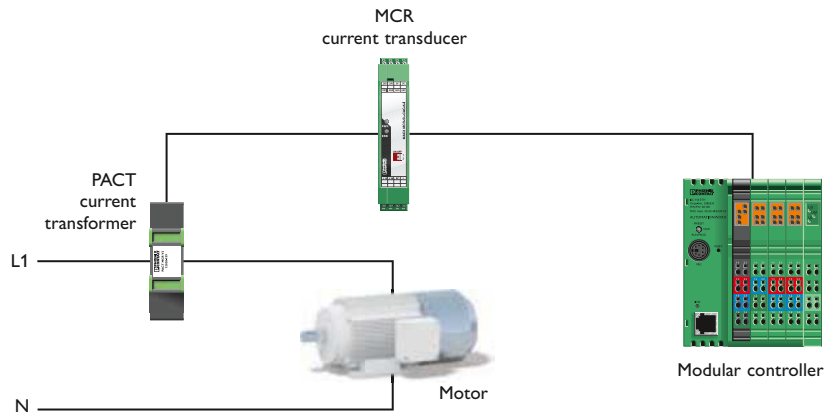

Load monitoring

When combined with a PACT current transformer, a real power monitoring relay can even monitor the load of larger motors.

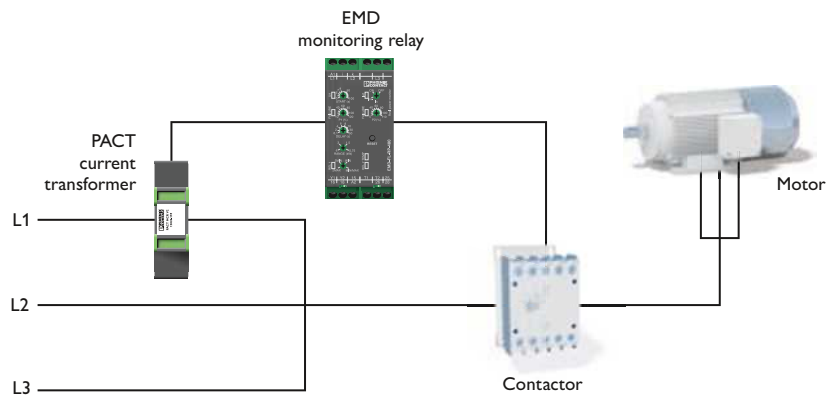

Motor manager

The CONTACTRON EMM motor manager protects the motor and system against critical overload and underload states.

- Integrated full motor protection
- Saves the cost of sensors
- Protection of high-quality system parts

Monitoring relays

EMD monitoring relays offer an inexpensive way of monitoring numerous machine and system parameters such as:

- Current and voltage
- Phase parameters
- Power factor and real power
- Motor winding temperature
- Levels

Examples of use for PACT current transformers

Motor management

PACT current transformers also enable the use of load relays with motor management, even at higher currents.

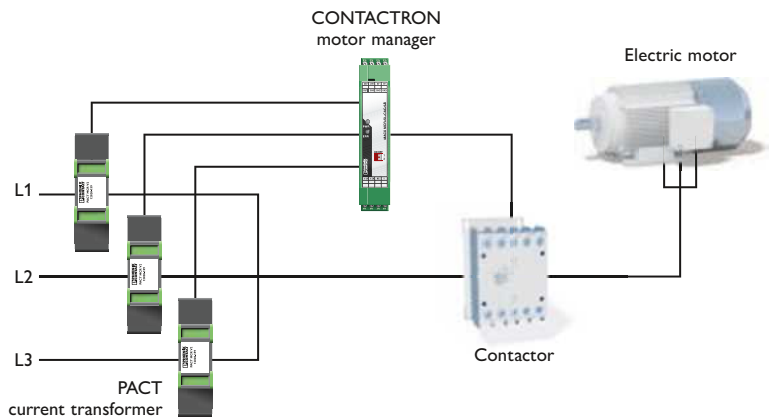

Energy measuring technology

The extensive PACT current transformer range supports various different applications in energy measuring technology: downstream EMpro energy meters can be used to acquire and display characteristic data directly in the control cabinet and then forward it to the PLC.

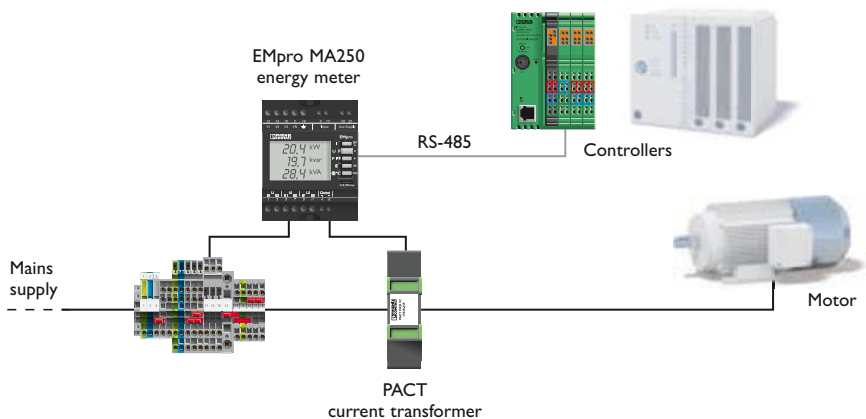

Power measurement terminal

The IB IL PM 3P/N/EF-PAC Inline power measurement terminal is used to analyze AC power grids and is used in distribution systems, for example, for measuring current, voltage, and power, as well as identifying distortion and harmonics.

- Supports 5 A AC direct connection
- Measurement of the neutral conductor current



Modular controller

The class 100 modular controllers can log operating states and energy data.

- Application can be freely programmed using the PC WORX software
- Comprehensive function libraries for direct SQL communication



Test disconnect terminal blocks

The compact test disconnect terminal blocks in the CLIPLINE complete system reliably protect your current transformers against damage. The patented plug ensures convenient automatic, leading short circuit.

Product overview: PACT current transformers



50 ... 500 A

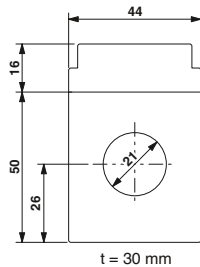

Type	Order No.	PACT MCR-V1-21-44	2277268
------	-----------	--------------------------	---------

Technical data	
Circular conductor dimensions	Ø 21 mm
Rail dimensions (maximum)	
Secondary current I_{sn}	1 A/5 A
Accuracy class	C05 = 0.5/C10 = 1

Primary rated current and rated power		
	I_{pn}	S_n
I_{sn} : 1 A/cl.: 0.5	100 ... 500 A	1.25 ... 10 VA
I_{sn} : 1 A/cl.: 1	50 ... 500 A	1.25 ... 10 VA
I_{sn} : 5 A/cl.: 0.5	100 ... 500 A	1.25 ... 7.5 VA
I_{sn} : 5 A/cl.: 1	50 ... 500 A	1.25 ... 10 VA

Calibratable version	Order No.	PACT MCR-V1C-21-44	2277420
----------------------	-----------	---------------------------	---------



50 ... 750 A

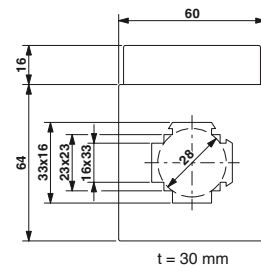

Type	Order No.	PACT MCR-V2-3015-60	2277271
------	-----------	----------------------------	---------

Technical data	
Circular conductor dimensions	Ø 28 mm
Rail dimensions (maximum)	30 x 15 mm 20 x 20 mm
Secondary current I_{sn}	1 A/5 A
Accuracy class	C05 = 0.5/C10 = 1

Primary rated current and rated power		
	I_{pn}	S_n
I_{sn} : 1 A/cl.: 0.5	100 ... 750 A	1.25 ... 15 VA
I_{sn} : 1 A/cl.: 1	50 ... 750 A	1.25 ... 20 VA
I_{sn} : 5 A/cl.: 0.5	200 ... 750 A	2.5 ... 10 VA
I_{sn} : 5 A/cl.: 1	60 ... 750 A	1.25 ... 15 VA

Calibratable version	Order No.	PACT MCR-V2C-3015-60	2277433
----------------------	-----------	-----------------------------	---------

Quick-action mechanism	Order No.	PACT FAST-MNT-W16-L40	2276638
------------------------	-----------	------------------------------	---------

Quick-action mechanism	Order No.	PACT FAST-MNT-W16-L65	2276641
------------------------	-----------	------------------------------	---------



75 ... 1000 A

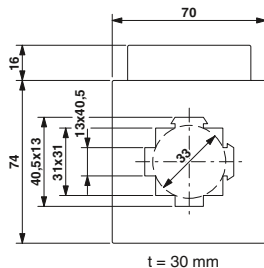

Type	Order No.	PACT MCR-V2-4012-70	2277284
------	-----------	----------------------------	---------

Technical data	
Circular conductor dimensions	Ø 33 mm
Rail dimensions (maximum)	40 x 12 mm 2 x 30 x 10 mm
Secondary current I_{sn}	1 A/5 A
Accuracy class	C05 = 0.5/C10 = 1

Primary rated current and rated power		
	I_{pn}	S_n
I_{sn} : 1 A/cl.: 0.5	125 ... 1000 A	1.25 ... 15 VA
I_{sn} : 1 A/cl.: 1	75 ... 1000 A	1.25 ... 15 VA
I_{sn} : 5 A/cl.: 0.5	125 ... 1000 A	1.25 ... 15 VA
I_{sn} : 5 A/cl.: 1	75 ... 1000 A	1.25 ... 15 VA

Calibratable version	Order No.	PACT MCR-V2C-4012-70	2277446
----------------------	-----------	-----------------------------	---------

Quick-action mechanism	Order No.	PACT FAST-MNT-W13-L40	2276612
------------------------	-----------	------------------------------	---------

Quick-action mechanism	Order No.	PACT FAST-MNT-W13-L65	2276625
------------------------	-----------	------------------------------	---------



100 ... 1500 A

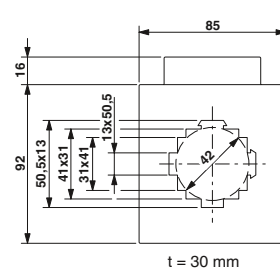

Type	Order No.	PACT MCR-V2-5012-85	2277297
------	-----------	----------------------------	---------

Technical data	
Circular conductor dimensions	Ø 42 mm
Rail dimensions (maximum)	50 x 12 mm 2 x 40 x 10 mm
Secondary current I_{sn}	1 A/5 A
Accuracy class	C05 = 0.5/C10 = 1

Primary rated current and rated power		
	I_{pn}	S_n
I_{sn} : 1 A/cl.: 0.5	150 ... 1500 A	1.25 ... 15 VA
I_{sn} : 1 A/cl.: 1	100 ... 1500 A	1.25 ... 30 VA
I_{sn} : 5 A/cl.: 0.5	150 ... 1500 A	1.25 ... 15 VA
I_{sn} : 5 A/cl.: 1	100 ... 1500 A	1.25 ... 20 VA

Calibratable version	Order No.	PACT MCR-V2C-5012-85	2277459
----------------------	-----------	-----------------------------	---------

Quick-action mechanism	Order No.	PACT FAST-MNT-W13-L40	2276612
------------------------	-----------	------------------------------	---------

Quick-action mechanism	Order No.	PACT FAST-MNT-W13-L65	2276625
------------------------	-----------	------------------------------	---------

Product overview: PACT current transformers

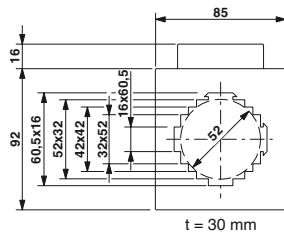

200 ... 1600 A

Type	Order No.	PACT MCR-V2-6015-85	2277336
Technical data			
Circular conductor dimensions	Ø 52 mm		
Rail dimensions (maximum)	60 x 15 mm 2 x 50 x 10 mm 40 x 40 mm		
Secondary current I_{sn}	1 A/5 A		
Accuracy class	C05 = 0.5/C10 = 1		
Primary rated current and rated power			
	I_{pn}	S_n	
I_{sn} : 1 A/cl.: 0.5	250 ... 1250 A	1.25 ... 5 VA	
I_{sn} : 1 A/cl.: 1	200 ... 1250 A	2.5 ... 5 VA	
I_{sn} : 5 A/cl.: 0.5	250 ... 1600 A	1.25 ... 20 VA	
I_{sn} : 5 A/cl.: 1	200 ... 1600 A	2.5 ... 30 VA	
Calibratable version	Order No.	PACT MCR-V2C-6015-85	2277462
Quick-action mechanism	Order No.	PACT FAST-MNT-W16-L40	2276638
Quick-action mechanism	Order No.	PACT FAST-MNT-W16-L65	2276641

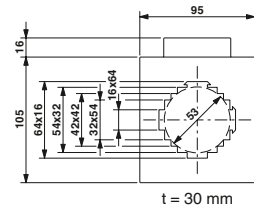

200 ... 2500 A

Type	Order No.	PACT MCR-V2-6315-95	2277307
Technical data			
Circular conductor dimensions	Ø 53 mm		
Rail dimensions (maximum)	63 x 15 mm 2 x 50 x 10 mm 40 x 40 mm		
Secondary current I_{sn}	1 A/5 A		
Accuracy class	C05 = 0.5/C10 = 1		
Primary rated current and rated power			
	I_{pn}	S_n	
I_{sn} : 1 A/cl.: 0.5	200 ... 2000 A	2.5 ... 20 VA	
I_{sn} : 1 A/cl.: 1	200 ... 2000 A	2.5 ... 20 VA	
I_{sn} : 5 A/cl.: 0.5	200 ... 2500 A	2.5 ... 30 VA	
I_{sn} : 5 A/cl.: 1	200 ... 2500 A	2.5 ... 45 VA	
Calibratable version	Order No.	PACT MCR-V2C-6315-95	2277475
Quick-action mechanism	Order No.	PACT FAST-MNT-W16-L40	2276638
Quick-action mechanism	Order No.	PACT FAST-MNT-W16-L65	2276641

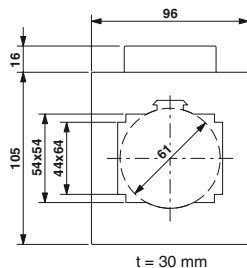

200 ... 2000 A

Type	Order No.	PACT MCR-V2-6040-96	2277349
Technical data			
Circular conductor dimensions	Ø 61 mm		
Rail dimensions (maximum)	60 x 40 mm 50 x 50 mm		
Secondary current I_{sn}	1 A/5 A		
Accuracy class	C05 = 0.5/C10 = 1		
Primary rated current and rated power			
	I_{pn}	S_n	
I_{sn} : 1 A/cl.: 0.5	250 ... 1500 A	2.5 ... 10 VA	
I_{sn} : 1 A/cl.: 1	200 ... 1500 A	2.5 ... 10 VA	
I_{sn} : 5 A/cl.: 0.5	250 ... 2000 A	2.5 ... 15 VA	
I_{sn} : 5 A/cl.: 1	200 ... 2000 A	2.5 ... 15 VA	
Calibratable version	Order No.	PACT MCR-V2C-6040-96	2277488

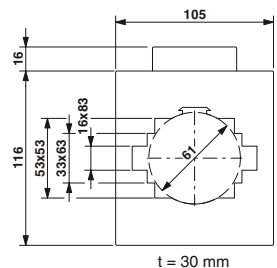

400 ... 2500 A

Type	Order No.	PACT MCR-V2-8015-105	2277352
Technical data			
Circular conductor dimensions	Ø 61 mm		
Rail dimensions (maximum)	80 x 15 mm 2 x 60 x 10 mm 3 x 50 x 10 mm		
Secondary current I_{sn}	1 A/5 A		
Accuracy class	C05 = 0.5/C10 = 1		
Primary rated current and rated power			
	I_{pn}	S_n	
I_{sn} : 1 A/cl.: 0.5	400 ... 2000 A	2.5 ... 20 VA	
I_{sn} : 1 A/cl.: 1	400 ... 2000 A	2.5 ... 25 VA	
I_{sn} : 5 A/cl.: 0.5	400 ... 2500 A	2.5 ... 20 VA	
I_{sn} : 5 A/cl.: 1	400 ... 2500 A	2.5 ... 30 VA	
Calibratable version	Order No.	PACT MCR-V2C-8015-105	2277491

Product overview: PACT current transformers



500 ... 2000 A

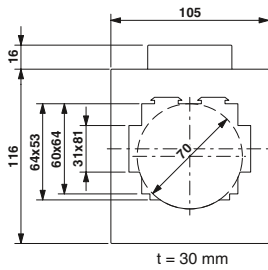

Type	Order No.	PACT MCR-V2-8020-105	2277365
------	-----------	-----------------------------	---------

Technical data	
Circular conductor dimensions	∅ 70 mm
Rail dimensions (maximum)	2 x 80 x 10 mm 60 x 60 mm
Secondary current I_{sn}	1 A/5 A
Accuracy class	C05 = 0.5/C10 = 1

Primary rated current and rated power		
	I_{pn}	S_n
I_{sn} : 1 A/cl.: 0.5	500 ... 1600 A	2.5 ... 10 VA
I_{sn} : 1 A/cl.: 1	500 ... 1600 A	2.5 ... 15 VA
I_{sn} : 5 A/cl.: 0.5	500 ... 2000 A	2.5 ... 15 VA
I_{sn} : 5 A/cl.: 1	500 ... 2000 A	2.5 ... 15 VA

Calibratable version	Order No.	PACT MCR-V2C-8020-105	2277501
----------------------	-----------	------------------------------	---------



400 ... 4000 A

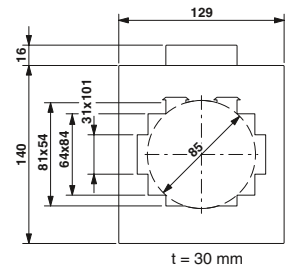

Type	Order No.	PACT MCR-V2-10020-129	2277378
------	-----------	------------------------------	---------

Technical data	
Circular conductor dimensions	∅ 85 mm
Rail dimensions (maximum)	2 x 100 x 10 mm 80 x 64 mm
Secondary current I_{sn}	1 A/5 A
Accuracy class	C05 = 0.5/C10 = 1

Primary rated current and rated power		
	I_{pn}	S_n
I_{sn} : 1 A/cl.: 0.5	500 ... 3000 A	2.5 ... 20 VA
I_{sn} : 1 A/cl.: 1	400 ... 3000 A	2.5 ... 30 VA
I_{sn} : 5 A/cl.: 0.5	500 ... 4000 A	2.5 ... 25 VA
I_{sn} : 5 A/cl.: 1	400 ... 4000 A	2.5 ... 30 VA

Calibratable version	Order No.	PACT MCR-V2C-10020-129	2277514
----------------------	-----------	-------------------------------	---------



400 ... 4000 A

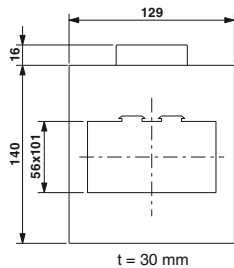

Type	Order No.	PACT MCR-V2-10036-129	2277381
------	-----------	------------------------------	---------

Technical data	
Circular conductor dimensions	–
Rail dimensions (maximum)	3 x 100 x 12 mm
Secondary current I_{sn}	1 A/5 A
Accuracy class	C05 = 0.5/C10 = 1

Primary rated current and rated power		
	I_{pn}	S_n
I_{sn} : 1 A/cl.: 0.5	500 ... 3000 A	2.5 ... 20 VA
I_{sn} : 1 A/cl.: 1	400 ... 3000 A	2.5 ... 30 VA
I_{sn} : 5 A/cl.: 0.5	500 ... 4000 A	2.5 ... 25 VA
I_{sn} : 5 A/cl.: 1	400 ... 4000 A	2.5 ... 30 VA

Calibratable version	Order No.	PACT MCR-V2C-10036-129	2277527
----------------------	-----------	-------------------------------	---------



400 ... 4000 A

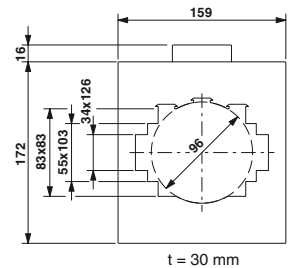

Type	Order No.	PACT MCR-V2-12020-159	2277394
------	-----------	------------------------------	---------

Technical data	
Circular conductor dimensions	∅ 96 mm
Rail dimensions (maximum)	2 x 120 x 10 mm 3 x 100 x 10 mm 80 x 80 mm
Secondary current I_{sn}	1 A/5 A
Accuracy class	C05 = 0.5/C10 = 1

Primary rated current and rated power		
	I_{pn}	S_n
I_{sn} : 1 A/cl.: 0.5	400 ... 4000 A	2.5 ... 45 VA
I_{sn} : 1 A/cl.: 1	400 ... 4000 A	2.5 ... 45 VA
I_{sn} : 5 A/cl.: 0.5	400 ... 4000 A	2.5 ... 45 VA
I_{sn} : 5 A/cl.: 1	400 ... 4000 A	2.5 ... 45 VA

Product overview: PACT current transformers



400 ... 4000 A

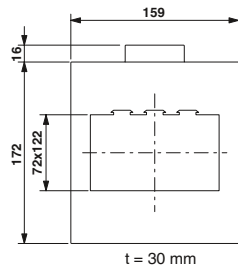

Type	Order No.	PACT MCR-V2-12040-159	2277404
------	-----------	------------------------------	---------

Technical data	
Circular conductor dimensions	–
Rail dimensions (maximum)	4 x 120 x 10 mm
Secondary current I_{sn}	1 A/5 A
Accuracy class	C05 = 0.5/C10 = 1

Primary rated current and rated power		
	I_{pn}	S_n
I_{sn} : 1 A/cl.: 0.5	400 ... 4000 A	2.5 ... 30 VA
I_{sn} : 1 A/cl.: 1	400 ... 4000 A	2.5 ... 30 VA
I_{sn} : 5 A/cl.: 0.5	400 ... 4000 A	2.5 ... 30 VA
I_{sn} : 5 A/cl.: 1	400 ... 4000 A	2.5 ... 30 VA



1 ... 40 A

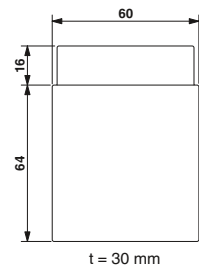

Type	Order No.	PACT MCR-V3-60	2277417
------	-----------	-----------------------	---------

Technical data	
Circular conductor dimensions	–
Rail dimensions (maximum)	–
Secondary current I_{sn}	1 A/5 A
Accuracy class	C05 = 0.5/C10 = 1

Primary rated current and rated power		
	I_{pn}	S_n
I_{sn} : 1 A/cl.: 0.5	1 ... 40 A	2.5 ... 5 VA
I_{sn} : 1 A/cl.: 1	1 ... 40 A	2.5 ... 5 VA
I_{sn} : 5 A/cl.: 0.5	1 ... 40 A	2.5 ... 5 VA
I_{sn} : 5 A/cl.: 1	1 ... 40 A	2.5 ... 5 VA

Accessories



Secondary terminal cover
to increase air and creepage distances when installed horizontally

PACT MCR-ETC-60	2277572
PACT MCR-ETC-75	2277585



Copper sleeves
for establishing a conductive connection for horizontal assembly

PACT MCR-CB-42-12	2277530
PACT MCR-CB-28-12	2277543
PACT MCR-CB-21-12	2277556
PACT MCR-CB-21-8	2277569



Adapter
for mounting on DIN rails

PACT MCR-RA	2277598
--------------------	---------



Insulating caps
for mounting screws

PACT MCR-ICAP	2277608
----------------------	---------



Quick-action mechanisms
The distance between the top edge of the power rail and the holding latch varies according to the current transformer housing and the power rail material. Choose between the two lengths based on the above information.

* W = Width of holding latch
L = Length of fixing pins

PACT FAST-MNT-W13-L65	2276625
W [*] : 13 mm, L [*] : 65 mm; for:	
PACT MCR-V2-4012-70-...	
PACT MCR-V2-5012-85-...	

PACT FAST-MNT-W13-L40	2276612
W [*] : 13 mm, L [*] : 40 mm; for:	
PACT MCR-V2-4012-70-...	
PACT MCR-V2-5012-85-...	

PACT FAST-MNT-W16-L65	2276641
W [*] : 16 mm, L [*] : 65 mm; for:	
PACT MCR-V2-3015-60-...	
PACT MCR-V2-6015-85-...	
PACT MCR-V2-6315-95-...	

PACT FAST-MNT-W16-L40	2276638
W [*] : 16 mm, L [*] : 40 mm; for:	
PACT MCR-V2-3015-60-...	
PACT MCR-V2-6015-85-...	
PACT MCR-V2-6315-95-...	

Sensors and meters – keep an eye on the use of resources

Resources such as water and compressed air are expensive. Using sensors and meters from Phoenix Contact you can always determine the exact amount supplied. Thanks to calorimetric measurement, even the smallest quantities are recorded. You can therefore detect wear or leaks based on the amount of air consumed. Keep an eye on your system and reduce costs as a result. You can connect the sensors and meters to a controller via an IO-Link master in Inline format.



Pressure sensor with IO-Link

Pressure sensors from Phoenix Contact record the operating pressure of liquid or gas media in the range from -1 to 10 bar. The overload-proof ceramic measuring cell is designed for in excess of 100 million cycles and provides a high switching point accuracy. The pressure switch enables the set switching points to be used via two switching outputs or all process data to be read via the IO-Link interface.

IO-Link



Your advantages:

- Efficient use of resources, thanks to comprehensive procurement data from sensors and meters
- Detailed procurement measurement, thanks to precise sensor and meter technology
- Intelligent sensor communication, thanks to IO-Link technology
- Keep an eye on process values at all times – with the integrated display on pressure sensors

Product overview: compressed air meters and pressure sensor

Record the following values:

- Current volumetric flow according to ISO 2533 and DIN 1343
- Total volume used
- Temperature of the compressed air in the monitored operating processes



Compressed air meter up to 15 Nm³/h



Compressed air meter up to 75 Nm³/h



Compressed air meter up to 75 Nm³/h

Product designation	Order No.	PSK AFS5000IOL	2700705	PSK AFS6000IOL	2700707	PSK AFS6050IOL	2700704
---------------------	-----------	----------------	---------	----------------	---------	----------------	---------

Technical data

Measuring range [Nm ³ /h]	0.06 ... 15.0	0.25 ... 75.0	0.25 ... 75.0
Pulse value [m ³]	0.001 ... 1,000,000	0.001 ... 1,000,000	0.001 ... 1,000,000
Measuring accuracy [% of final value]	A: ±3% MV + 0.3% MRFV B: ±6% MV + 0.6% MRFV	A: ±3% MV + 0.3% MRFV B: ±6% MV + 0.6% MRFV	A: ±15% MV + 1.5% MRFV B: ±15% MV + 1.5% MRFV
Process connection	G 1/4	R 1/2	G 1/2

Record the following values:

- Current volumetric flow according to ISO 2533 and DIN 1343
- Total volume used
- Temperature of the compressed air in the monitored operating processes
- Operating pressure (pressure sensor)



Compressed air meter up to 225 Nm³/h



Compressed air meter up to 700 Nm³/h



Pressure sensor up to 10 bar

Product designation	Order No.	PSK AFS8000IOL	2700708	PSK AFS2000IOL	2700709	PSK APS70004IOL	2700710
---------------------	-----------	----------------	---------	----------------	---------	-----------------	---------

Technical data

Measuring range [Nm ³ /h], [bar]	0.75 ... 225.0	2.3 ... 700.0	-1 ... 10
Pulse value [m ³]	0.003 ... 3,000,000	0.010 ... 4,000,000	
Measuring accuracy [% of final value]	A: ±3% MV + 0.3% MRFV B: ±6% MV + 0.6% MRFV	A: ±3% MV + 0.3% MRFV B: ±6% MV + 0.6% MRFV	±0.05%
Process connection	R 1	R 2	G1/4 I

Costs caused by leaks* in systems

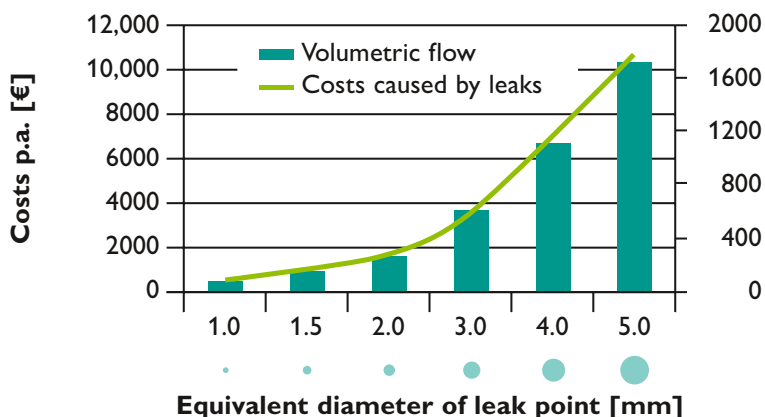

Record usage, reduce costs

When leaks are detected in compressed air networks, huge potential cost savings can usually be found. In order to not only identify these potential savings, but also reduce usage, all energy flow in a company must be recorded and logged. All in all, even the smallest consumption rates play a role. The compact volumetric flow sensors operate according to the calorimetric measuring principle and therefore even detect flow rates of 0.06 Nm³/h upwards.

*Example costing

Software for energy and power measurement – manage resource consumption

In conjunction with a modular controller, the new EMwise software from Phoenix Contact is the efficient solution for acquiring energy data for heat, cold, air or electricity. You can therefore keep an eye on your resources at all times and efficiently manage their use in your machines and systems.



Modular controller

Class 100 modular controllers impress with their high function density at low prices. They support all common communication paths, such as Ethernet, mobile phone or fixed-line network. The controllers can be easily extended with Inline I/O modules and offer an integrated web server. As the interface between the control center and I/O level, they efficiently control the data flow within your system.



Your advantages:



- Fast startup of multiple devices – configurations that are created can be easily copied to other applications
- Easy parameterization, thanks to web-based interface
- Direct parameterization of predefined sensors
- Measured data can be logged, thanks to SQL link

Easy retrofitting of central energy data acquisition

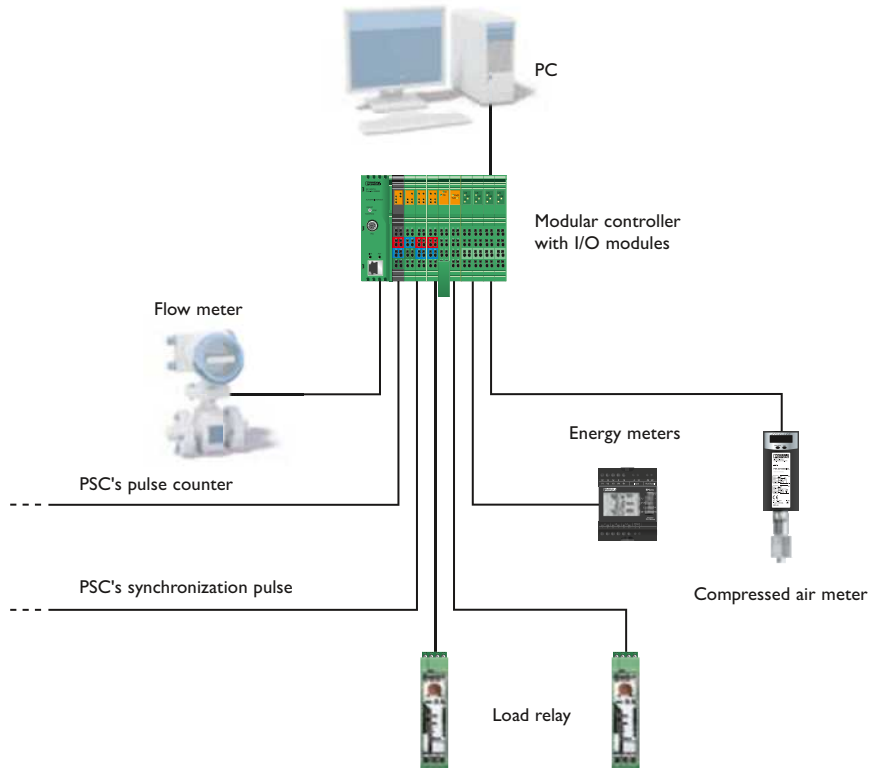
Energy data acquisition for retrofitting is the ideal solution for any company where energy efficiency is important – whether in production or the company infrastructure. With the EMwise software you can use existing components and retrofit comprehensive and accurate usage data acquisition based on a modular controller. This also means that you can accurately attribute the measuring points obtained to buildings and system parts. On the one hand this means that resources can be saved; on the other hand if energy usage is well documented and evidence is provided, companies can apply for government aid.



Three performance classes – suitable for every area of application

			
Description	Program and configuration memory	Program and configuration memory	Program and configuration memory
System requirements	ILC 131 ETH modular controller	ILC 131 ETH modular controller	ILC 191 ME/AN modular controller
Function	Evaluation of digital pulse inputs	Evaluation of digital and analog signals	Evaluation of digital and analog signals, communication via Modbus
Designation	SD FLASH 2GB EMWISE IMPULS	SD FLASH 2GB EMWISE IMP ANALOG	SD FLASH 2GB EMWISE EXTENDED
Signals	For up to 16 digital signals	For up to 16 digital and 6 analog signals	For up to 16 digital and 6 analog signals, EMpro energy meters, M-bus counters, M-bus level converters, IO-Link sensors
Order No.	2701745	2701746	2701747

AC/DC current transducers – current measurement for all waveforms

MCR current transducers can be used to measure direct and alternating currents of any waveform. Choose between adjustable devices for precise mapping of small measuring ranges up to 55 A or compact devices in graded measuring ranges for measuring high currents up to 600 A.

For high currents

Current transducers up to 600 A AC/DC



Your advantages:

- Distributed use, thanks to compact dimensions
- Variable mounting – on DIN rail or mounting plate
- Easy wiring, thanks to COMBICON plug-in connection terminal blocks
- For insulated conductors up to 32 mm in diameter

Flexible signal conditioning

Current transducers up to 55 A AC/DC



Your advantages:

- Quick basic configuration via DIP switches
- Advanced configuration and diagnostic options via software
- Optimum mapping of the measuring range, thanks to programmable upper and lower limits
- Limit value alarm – via relay or transistor output

Product overview: MCR current transducers for direct and alternating currents

MCR current transducers in the range of 0 ... 11 A and 0 ... 55 A operate according to the principle of true r.m.s. measurement. They therefore process all waveforms regardless of the form factor.

If desired, they can also be supplied ready-configured in accordance with your data.

For additional information on current measurement and true r.m.s. value measurement, please refer to page 23.



**For DC/AC and distorted currents
0 ... 11 A
programmable and configurable**



**For DC/AC and distorted currents
0 ... 55 A
programmable and configurable**

Configurable, with switching output	Order No.	MCR-S-1-5-UI-SW-DCI	2814650	MCR-S-10-50-UI-SW-DCI	2814663
Standard item, with switching output	Order No.	MCR-S-1-5-UI-SW-DCI-NC	2814731	MCR-S10-50-UI-SW-DCI-NC	2814744
Configurable, without switching output	Order No.	MCR-S-1-5-UI-DCI	2814634	MCR-S-10-50-UI-DCI	2814647
Standard item, without switching output	Order No.	MCR-S-1-5-UI-DCI-NC	2814715	MCR-S10-50-UI-DCI-NC	2814728

Technical data		
Current measurement	0 ... 11 A AC/DC (programmable, configurable)	0 ... 55 A AC/DC (programmable, configurable)
Frequency range	15 ... 400 Hz	15 ... 400 Hz
Connection method	Screw connection	Push-through connection, Ø 10.5 mm
Output signal (current output)	0 ... 20 mA/4 ... 20 mA	0 ... 20 mA/4 ... 20 mA
Output signal (voltage output)	0 ... 5 V/1 ... 5 V/0 ... 10 V/2 ... 10 V/-5 ... 5 V/-10 ... 10 V	0 ... 5 V/1 ... 5 V/0 ... 10 V/2 ... 10 V/-5 ... 5 V/-10 ... 10 V
Supply voltage U_B	20 ... 30 V DC	20 ... 30 V DC
Maximum transmission error	< 0.5% (of nominal range value under nominal conditions)	< 0.5% (of nominal range value under nominal conditions)
Ambient temperature range	-20 ... +60°C	-20°C ... +60°C

MCR current transducers in the range of 0 ... 300 A and 0 ... 600 A operate according to the principle of true r.m.s. measurement. They therefore process all waveforms regardless of the form factor.

For additional information on current measurement and true r.m.s. value measurement, please refer to page 23.



**For DC/AC and distorted currents
0 ... 300 A
Voltage output**



**For DC/AC and distorted currents
0 ... 600 A
Current output**

Input current range: 0 ... 100 A	Order No.	MCR-SL-CUC-100-U	2308108	MCR-SL-CUC-100-I	2308027
Input current range: 0 ... 200 A	Order No.	MCR-SL-CUC-200-U	2308205	MCR-SL-CUC-200-I	2308030
Input current range: 0 ... 300 A	Order No.	MCR-SL-CUC-300-U	2308302	MCR-SL-CUC-300-I	2308043
Input current range: 0 ... 400 A	Order No.			MCR-SL-CUC-400-I	2308072
Input current range: 0 ... 500 A	Order No.			MCR-SL-CUC-500-I	2308085
Input current range: 0 ... 600 A	Order No.			MCR-SL-CUC-600-I	2308098

Technical data		
Current measurement	0 ... 100 A, 200 A, 300 A	0 ... 100 A, 200 A, 300 A, 400 A, 500 A, 600 A
Frequency range	20 ... 6000 Hz	20 ... 6000 Hz
Connection method	Cable fit, Ø 32 mm	Cable fit, Ø 32 mm
Output signal	0 ... 10 V	4 ... 20 mA
Supply voltage U_B	20 ... 30 V DC	20 ... 30 V DC
Maximum transmission error	< ±1% (of final value)	< ±1% (of final value)
Ambient temperature range	-40 ... +65°C	-40 ... +65°C

AC current transducers – for sinusoidal and non-sinusoidal alternating currents

MCR current transducers can also be used to acquire distorted alternating currents and convert them into a standard analog signal. There are two product ranges: an adjustable version with a variable supply concept or a version with a hinged Rogowski sensor for easy installation and retrofitting.

Convenient installation

Current transducers
up to 200 A



Your advantages:

- Uninterrupted installation with hinged sensor
- Current measurement without shunt, thanks to Rogowski sensor
- Easy wiring, thanks to plug-in connection terminal blocks
- Mounting on DIN rail or mounting plate

Adjustable and flexible supply

Current transducers
up to 12 A



Ex n

Your advantages:

- Input and output signal set via DIP switch
- Versions for worldwide use with wide range input
- 24 V supply via DIN rail connector
- Operating state diagnostics via LED on the front
- Protection against disturbances, thanks to three-way electrical isolation

Product overview: MCR current transducers for alternating currents

MCR current transducers in the range of 0 ... 5 A and 0 ... 12 A operate according to the principle of true r.m.s. measurement. They therefore process all waveforms regardless of the form factor.

For additional information on current measurement and true r.m.s. value measurement, please refer to page 23.



For sinusoidal alternating currents up to 0 ... 5 A/0 ... 12 A (configurable)



For sinusoidal and non-sinusoidal alternating currents up to 0 ... 200 A, with voltage output (...-U), with current output, loop-powered (...-I-LP)

Type	Order No.	MACX MCR-SL-CAC-5-I	2810612	MCR-SL-S-100-U	2813457
Type	Order No.	MACX MCR-SL-CAC-5-I-UP	2810625	MCR-SL-S-100-I-LP	2813486
Type	Order No.	MACX MCR-SL-CAC-12-I-UP	2810638	MCR-SL-S-200-U	2813460
Type	Order No.			MCR-SL-S-200-I-LP	2813499

Technical data

Current measurement	0 ... 1 A/0 ... 5 A (configurable, ...-5-I and ...-5-I-UP)	0 ... 50/75/100 A (...-S-100-U and ...-S-100-I-LP)
	0 ... 5 A/0...12 A (configurable, ...12-I-UP)	0 ... 100/150/200 A (...-S-200-U and ...-S-200-I-LP)
Frequency range	45 ... 65 Hz	30 ... 6000 Hz
Connection method	Screw connection	Cable fit, Ø 18.5 mm
Output signal	0 ... 20 mA/4 ... 20 mA (configurable)	0 ... 5 V/0 ... 10 V (...-U); 4 ... 20 mA (...-I-LP)
Supply voltage U_B	19.2 ... 30 V DC (...-I)	20 ... 30 V DC
	19.2 ... 253 V AC/DC (...-UP versions)	
Maximum transmission error	< 0.5% (of nominal range value under nominal conditions)	< 1% (of final value)
Ambient temperature range	-20 ... +65°C	-20 ... +60°C

Passive current transducer for sinusoidal alternating currents of 0 ... 1 A/0 ... 5 A

- Loop-powered
- 1 A AC and 5 A AC measuring ranges, reconnectable

The current protector converts sinusoidal alternating currents of up to 16 A AC to binary switching signals.

- Freely selectable switching point
- Relay PDT output
- Adjustable switching hysteresis
- 3-way isolation
- Adjustable operating/closed-circuit current behavior



Passive current transducer for sinusoidal alternating currents 0 ... 1 A/0 ... 5 A loop-powered



Current protector for sinusoidal alternating currents 0 ... 16 A AC

Type	Order No.	MCR-SLP-1-5-UI-0	2814359	MCR-SL-S-16-SP-24	2864464
------	-----------	-------------------------	---------	--------------------------	---------

Technical data

Current measurement	0 ... 1 A/0 ... 5 A (reconnectable)	0 ... 16 A AC
Frequency range	45 ... 60 Hz	45 ... 65 Hz
Connection method	Screw connection	Push-through connection, Ø 4.2 mm
Output signal	0 ... 10 V/0 ... 20 mA	Relay output: 1 PDT
Response delay	–	Typically 0.1 ... 10 s (adjustable via potentiometer)
Supply voltage U_B	Loop-powered	20 ... 30 V DC
Maximum transmission error	< 0.5% (of final value)	–
Ambient temperature range	-25 ... +60°C	-25 ... +65°C

Photovoltaic string monitoring – utilize solar electricity efficiently

Detect errors – increase efficiency: photovoltaic systems should achieve maximum energy yield within the shortest possible time.

SOLARCHECK provides reliable information regarding the state of your photovoltaic system. You can therefore respond to errors in individual strings directly and take appropriate countermeasures.



Your advantages:

- Low costs and wiring effort, as an additional power supply unit is not required in the device connection box
- Design flexibility for string boxes, thanks to 4 and 8-channel versions
- Space-saving installation, thanks to the compact design
- Easy integration in monitoring systems, thanks to Modbus RTU communication
- Monitoring of remote indication contacts by means of an additional digital input
- Flexible expansion, thanks to optional voltage measurement of up to 1500 V DC



Communication module

The communication module collects the values from the measuring modules and, as a Modbus slave, forwards them to your central control system. It is also used to supply the measuring modules in the field. The communication module is simply integrated into an existing network as a Modbus RTU device.

Current measuring modules

In a measuring module just 22.5 mm wide, the characteristic data of your PV systems is determined on a contact-free basis with the aid of Hall sensors and forwarded to the communication module. 4 and 8-channel versions are available.

Voltage measuring module

With the voltage measuring module you can measure DC voltages up to 1500 V. The module is suitable for measuring in both grounded and isolated PV systems. You can also flexibly use the voltage measurement outside the monitoring system as a simple analog device.



16-channel current measurement with space-saving installation

PV string monitoring couldn't be easier with SOLARCHECK

Lead the power cables quickly and easily through the openings in the measuring module. The 2-wire communication cable is also used to supply the measuring modules with power. This means that you can supply up to eight measuring modules with one communication module – without an additional power supply. With a width of just 22.5 mm, the narrow measuring module bundles the cables in a confined space. This saves space in your control cabinet. Combine 4 and 8-channel current measuring modules to tailor the system to your application.

Monitoring photovoltaic strings

The measuring system can be used to measure up to eight direct currents and one DC voltage value at the same time. The complete system enables you to operate eight measuring modules on one communication module. The two-wire communication cable is also used to supply the measuring modules with power. Only one central power supply is therefore required on the communication module for this configuration.

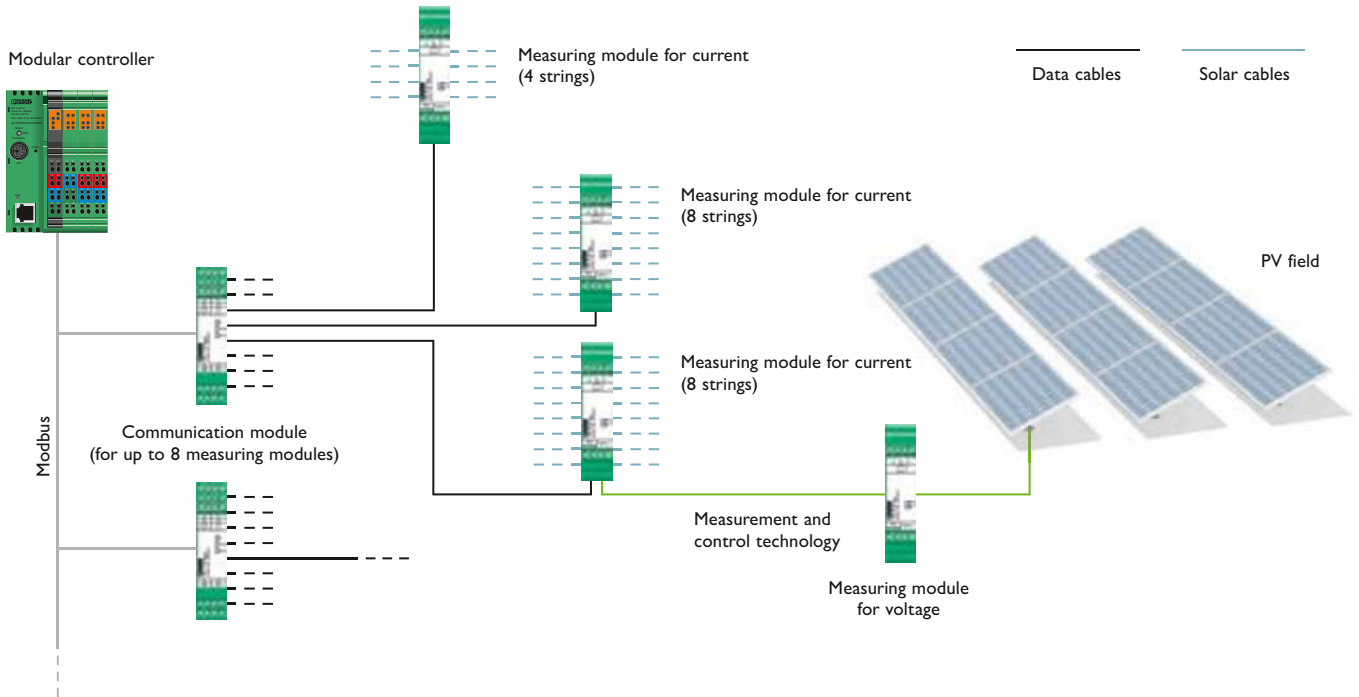

Automation and visualization

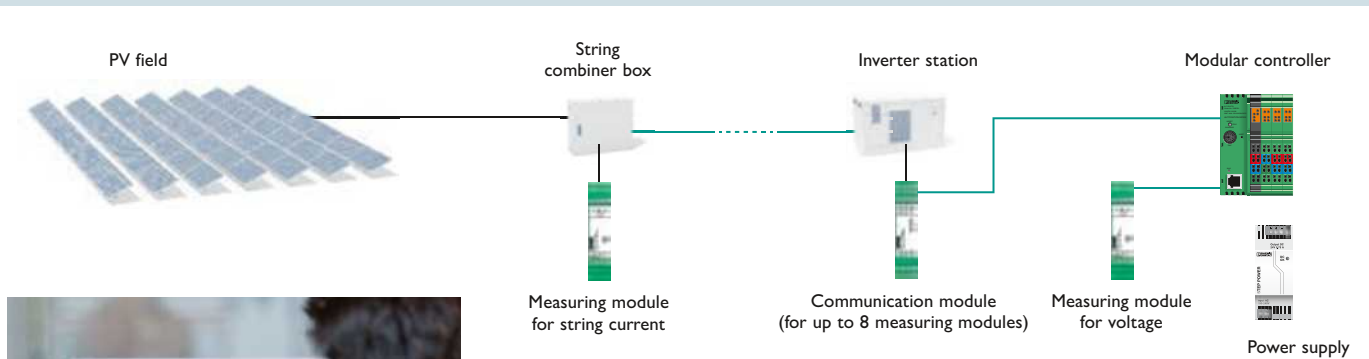

Use continuous production data acquisition and data management to increase the efficiency and yield of your PV system. Automation and visualization tools from Phoenix Contact enable worldwide networking of free-standing systems. This enables you to acquire and evaluate data at all times. The open register structure of the Solarcheck system enables quick and easy integration in your individual software environment.

Product overview: SOLARCHECK PV string monitoring

The modular Solarcheck monitoring system consists of various devices for current and voltage measurement and an associated communication module.



**Current measuring module,
20 A DC, 8-channel**



**Extension module, 4-channel,
current measurement, 20 A DC**

Type	Order No.	SCK-M-I-8S-20A	2903241	SCK-M-I-4S-20A	2903242
------	-----------	-----------------------	---------	-----------------------	---------

Technical data					
Current measurement		0 ... 20 A		0 ... 20 A	
Reverse current detection		-1 A ... 0 A		-1 A ... 0 A	
Supply voltage U_B		Via SCK-C-MODBUS module		Via SCK-C-MODBUS module	
Internal power consumption		45 mA		45 mA	
Temperature coefficient		0.02%/K (from T > 25°C)		0.02%/K (from T > 25°C)	
Maximum transmission error		< 1%		< 1%	
Degree of protection		IP20		IP20	
Ambient temperature range		-20 ... +70°C		-20 ... +70°C	



**Communication module
RS-485 (Modbus RTU)**



**Voltage measuring module
0...1500 V DC**

Type	Order No.	SCK-C-MODBUS	2901674	SCK-M-U-1500V	2903591
------	-----------	---------------------	---------	----------------------	---------

Technical data					
Voltage measurement		–		0 ... 1500 V DC	
		–		Output signal 2 ... 10 V	
Interfaces		RS-485 Modbus RTU		–	
Serial transmission speed		9.6 / 14.4 / 19.2 / 38.4 kbps		–	
Supply voltage U_B		24 V DC (-10% ... +25%)		Via SCK-M-I module or separate	
Internal power consumption		12 mA		35 mA	
Temperature coefficient		–		< 0.03%/K (from T > 25°C)	
Maximum transmission error		–		< 1% (after additional adjustment)	
Degree of protection		IP20		IP20	
Ambient temperature range		-20...+70°C		-20...+70°C	

Voltage transducers

MCR voltage transducers can be used to acquire DC and AC voltages in various signal ranges and convert them into standard analog signals.



Your advantages:

- Bidirectional output signals
- Precise mapping of the measuring result, thanks to graded voltage ranges
- ZERO/SPAN adjustment $\pm 20\%$
- High operational reliability, thanks to 3-way electrical isolation

Product overview: MCR voltage transducers



**For DC voltages
0 ... ± 660 V DC**



**For sinusoidal AC voltages
0 ... 440 V AC**

Type	Order No.	MCR-VDC-UI-B-DC	2811116	MCR-VAC-UI-O-DC	2811103
Technical data					
Voltage measurement/resistance	Bipolar: 0 ... 24/36/54/80/120/170/250/370/550 V DC		0 ... 24/36/54/80/120/170/250/370 V AC		
Resistance	24/36/54/80/120/170/250/370/550 k Ω		24/36/54/80/120/170/250/370 k Ω		
ZERO/SPAN adjustment	$\pm 20\%/\pm 20\%$		$\pm 20\%/\pm 20\%$		
Frequency range	-		45 ... 400 Hz		
Output signal	-10 ... 10 V/-20 ... 20 mA		0 ... 10 V/0 ... 20 mA/4 ... 20 mA		
Supply voltage U_B	18.5 ... 30.2 V DC		18.5 ... 30.2 V DC		
Maximum transmission error	< 1% (of final value)		< 1.5% (of final value)		
Ambient temperature range	-25 ... +50°C		-25 ... +60°C		

Basics of current acquisition

r.m.s. value acquisition according to the transformer principle (RMS)

According to Faraday's law of induction, a magnetic flux which changes over time produces an induced voltage at the terminals of a coil. A circuit arrangement consisting

of two electrically isolated but magnetically coupled circuits is known as a transformer. This is one of the simplest and most commonly used methods of current transfer.

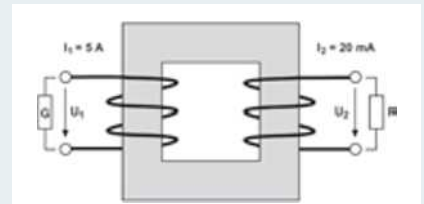

r.m.s. value acquisition according to the transformer principle (RMS)

True r.m.s. value acquisition according to the Rogowski principle (TRMS)

The Rogowski principle is a special method used to measure sinusoidal and non-sinusoidal alternating currents in a transformer. A non-ferrous induction coil (air-core coil), known as the Rogowski coil,

measures the magnetic voltage along a closed circumference around a live conductor. The output signal of the Rogowski coil is then conditioned so as to obtain an exact replica of the primary current.

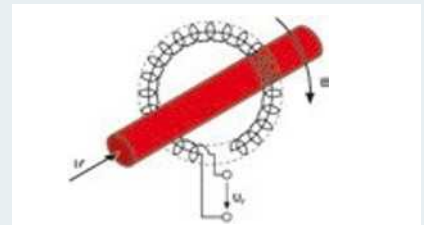

True r.m.s. value acquisition according to the Rogowski principle (TRMS)

True r.m.s. value acquisition with a Hall sensor (TRMS)

The magnetic flux generated by the primary current I_p is condensed in the magnetic circuit and measured in the air gap using a

Hall sensor. The output signal of the Hall sensor is then conditioned so that an exact replica of the primary current is obtained.

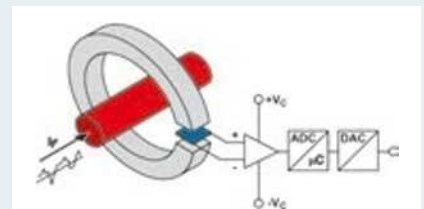

True r.m.s. value acquisition with a Hall sensor (TRMS)

Mean-value generation

r.m.s value (root mean square value)

The r.m.s. value of an alternating current corresponds to the steady-state value that results from the instantaneous values of this current. This steady-state value generates the same thermal work in an ohmic resistor as a direct current of identical magnitude.

The term "true r.m.s. value" also means that distorted, direct, and pulsating currents can be acquired. Here, the measuring transducer is compatible with any waveform. For a sinusoidal alternating current this means:

$$I_{rms} = \frac{I_s}{\sqrt{2}} \quad U_{rms} = \frac{U_s}{\sqrt{2}}$$

Arithmetic mean value

The arithmetic mean value is used to measure direct currents or filter a DC component out from a pulsating current. Applying the arithmetic mean value to a symmetrical alternating current would result in a measured value of "0".

The arithmetic mean value enables direct currents to be made available at the output in the form of standard analog signals. The polarity can be evaluated by means of a bipolar output signal.

For a 230 V/50 Hz power grid, this results in the following with regard to the voltage levels:

$$\begin{aligned} U_{rms} &= 230 \text{ V} \\ U_s &= 325 \text{ V} \\ U_{avg} &= 0 \text{ V} \end{aligned}$$

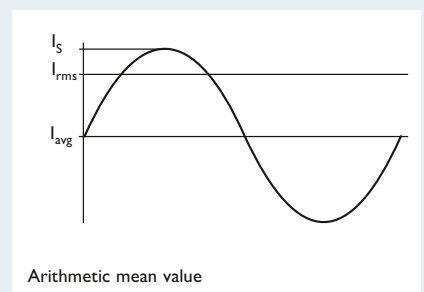

Arithmetic mean value



Always up-to-date, always available to you. Here you'll find everything on our products, solutions and service:

phoenixcontact.net

Product range

- Cables and wires
- Connectors
- Controllers
- Electronics housing
- Electronic switchgear and motor control
- Fieldbus components and systems
- Functional safety
- HMIs and industrial PCs
- I/O systems
- Industrial communication technology
- Industrial Ethernet
- Installation and mounting material
- Lighting and signaling
- Marking and labeling
- Measurement and control technology
- Modular terminal blocks
- Monitoring
- PCB terminal blocks and PCB connectors
- Power supply units and UPS
- Protective devices
- Relay modules
- Sensor/actuator cabling
- Software
- Surge protection and interference filters
- System cabling for controllers
- Tools
- Wireless data communication

PHOENIX CONTACT GmbH & Co. KG
 32825 Blomberg, Germany
 Phone: +49 (0) 52 35 3-00
 Fax: +49 (0) 52 35 3-4 12 00
phoenixcontact.net



SCATTERGOOD & JOHNSON LTD

ELECTRICAL ENGINEERING & FLUID CONTROL DISTRIBUTORS

Est.1899

At Scattergood & Johnson Ltd, we pride ourselves on being a technical distributor to specialist industries.

Working with a range of quality product suppliers across a number of specialist markets, we are not your average 'box shifter' - we are your technical and supply chain partner.

We fully support every product we sell - for free! Our internal team and external sales engineers can answer any product or application question, no matter the complexity.

Backing up this technical ability is a range of 50,000+ products available from stock for nationwide next day delivery (same day if required!), or you can collect what you need from any of our trade counters around the UK.

Select your specialist interest below to learn more about how we can help.

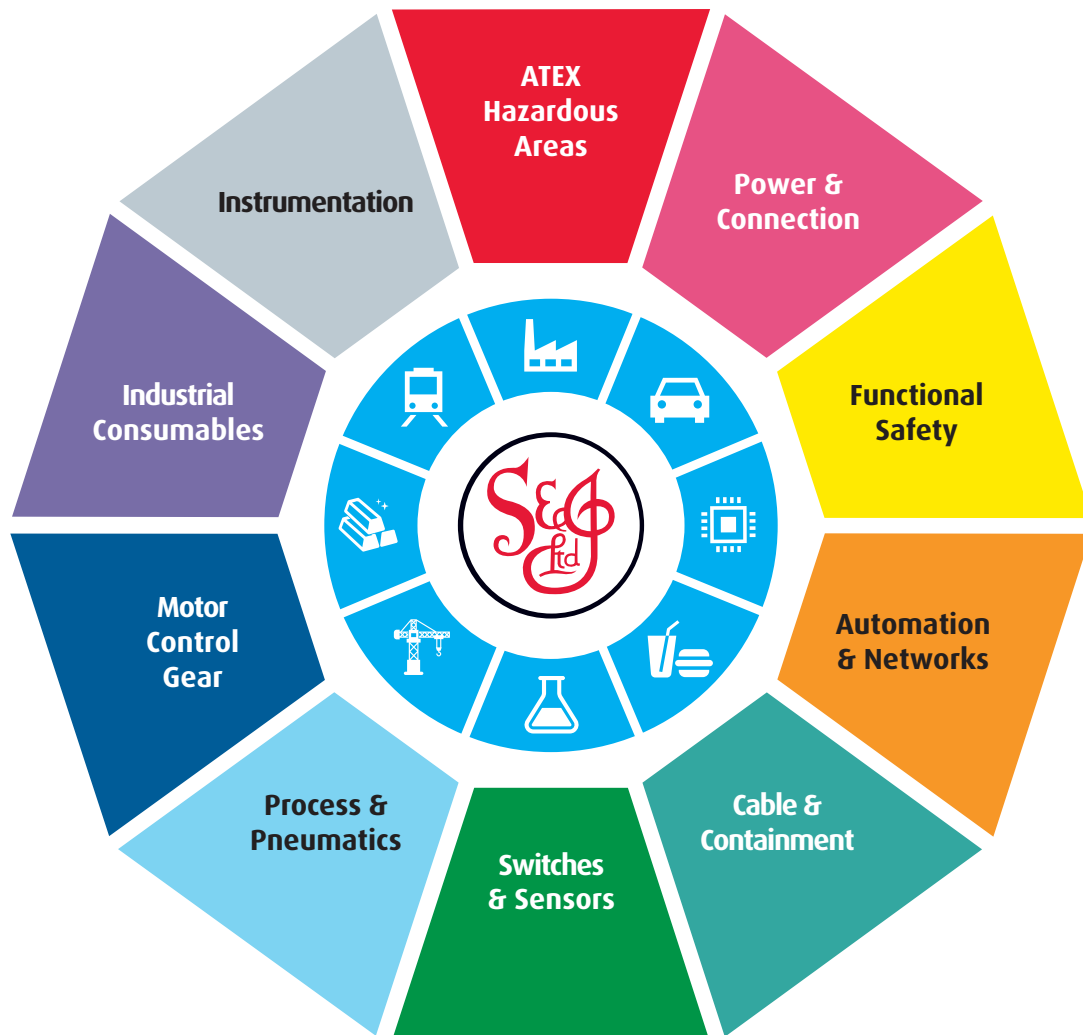

Online, In Branch and On the Road - Scattergood & Johnson Ltd, there when you need us.

www.scatts.co.uk