

Interface system gateways and digital extension modules

Quick start guide

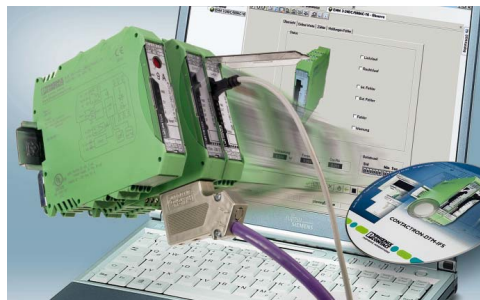

Application note
105793_en_03

© PHOENIX CONTACT 2016-04-18

1 Description

This document describes the startup and parameterization of Interface system (IFS) gateways in connection with other IFS devices, as for example EMM...IFS modules (motor management) or EM-D...-IFS (digital extension modules) using IFS-CONF software. The requirements are therefore met to permit connection to all common bus systems, such as PROFIBUS DP, PROFINET, Modbus, DeviceNet™, CANopen®, EtherNet/IP™, RS-232, and RS-485.

Communication between gateways and up to 32 IFS devices (slaves) is established via TBUS.

The maximum number of IFS devices depends on the number of process data words used (max. 64 words, divided in Access 1 fast cycle and Access 2 slow cycle, each of 32 words).



Make sure you always use the latest documentation.
It can be downloaded at phoenixcontact.net/products.

2 Contents

1	Description.....	1
2	Contents	2
3	System requirements	3
3.1	Supported operating systems.....	3
3.2	Hardware requirements.....	3
3.3	Software requirements	3
3.4	Programming adapters/cables	3
3.5	Configuration package	3
4	Connecting the programming adapter	4
4.1	Connection notes	4
4.2	Connection to the PC	4
4.3	Connection to the device.....	4
5	Software installation.....	5
5.1	Starting the application	5
6	Software configuration	5
6.1	Initial startup	5
6.2	Transferring CONTACTRON-DTM-IFS to catalog management.....	6
6.3	Topology scan.....	6
6.4	Connecting several devices via an IFS gateway.....	7
6.5	Functions.....	7
6.6	Options.....	8
7	Process data configuration	9
7.1	Definition of process data.....	9
7.2	Downloading process data	9
8	Monitoring dialog box	10
8.1	Gateways	10
8.2	Digital extension modules	10
9	Settings.....	11
9.1	CAN gateway EM-CAN-GATEWAY-IFS	11
9.2	Ethernet gateway EM-ETH-GATEWAY-IFS	12
9.3	RS-232 gateway EM-RS232-GATEWAY-IFS	16
9.4	RS-485 gateway EM-RS485-GATEWAY-IFS	17
9.5	PROFIBUS gateway EM-PB-GATEWAY-IFS	19
9.6	PROFINET gateway EM-PNET-GATEWAY-IFS	20
9.7	Modbus gateway EM-MBUS-GATEWAY-IFS	23
9.8	DeviceNet gateway EM-DNET-GATEWAY-IFS	27
9.9	Digital extension module EM-D-8/4-24DC-IFS	28
10	Diagnostics dialog box.....	29
10.1	Overview	29
10.2	Diagnostics.....	29
11	Saving the project.....	29

3 System requirements

3.1 Supported operating systems

- MS Windows 2000 with Service Pack 4
- MS Windows XP
- MS Windows Vista
- MS Windows 7

3.2 Hardware requirements

Hardware requirements	
CPU	Pentium III 1 GHz, 2 GHz (recommended)
RAM	1 GB (minimum), 2 GB (recommended) Windows Vista, Windows 7
	512 MB (minimum), 1 GB (recommended) Windows XP, Windows 2000 SP4
Hard disk space	500 MB free memory space
CD-ROM drive	Yes
Interfaces	1 x USB 2.0
Monitor	SVGA, resolution of 1024 x 768 pixels mini- mum; SXGA, resolution of 1280 x 1024 pixels rec- ommended
Operator panels	Keyboard, mouse

3.3 Software requirements

Software requirements for CONTACTRON motor management	
.Net Framework	Version 1.1
.Net Framework	Version 1.1 SP1
.Net Framework	Version 2.0
Windows Installer	Version 3.1
Internet browser	MS Internet Explorer Version 6.0 or later Mozilla Firefox Version 3.5 or later

Designation	Description
FDT container	IFS-CONF M&M
CONTACTRON-DTM-IFS	DTM devices for integrating the EMM module in the FDT container

3.4 Programming adapters/cables

Designation	Description	Order No.
IFS-USB- PROG- ADAPTER	Programming adapter for configuring Phoenix Contact INTERFACE modules with 12-pos. S-PORT interface	2811271
IFS-USB- DATACABLE	Data cable for communica- tion between industrial PC and Phoenix Contact devices with the 12-pos. IFS data port	2320500
IFS-TCP- PROG- ADAPTER	RJ45 network cable for com- munication between indus- trial PC and Phoenix Contact devices	-

3.5 Configuration package

Designation	Description	Order No.
MM-CONF-SET	The configuration package contains the following com- ponents: CONTACTRON-DTM-IFS IFS-USB-PROG-ADAPTER	2297992

4 Connecting the programming adapter

Use IFS-USB-PROG-ADAPTER programming adapter (Order No 2811271) or IFS-USB-DATACABLE (Order No. 2320500) for configuring Phoenix Contact INTERFACE modules with 12-pos. S-PORT interface.

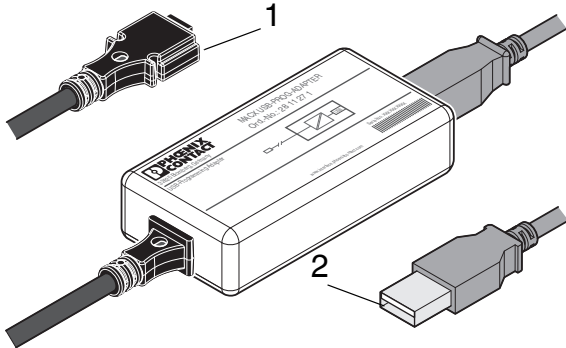

Figure 1 IFS-USB-PROG-ADAPTER

- 1 S-PORT connector
- 2 USB connector

4.1 Connection notes



WARNING: Risk of injury

The programming adapter must not be used in potentially explosive areas.
Do not use the programming adapter if you suspect that it is damaged.



The adapter may only be used to program supported Phoenix Contact INTERFACE devices. Check the documentation for your device to see whether the programming adapter is compatible. You must install the configuration software required for your device prior to initial startup. Observe the relevant device documentation for this purpose.

4.2 Connection to the PC

Connect the programming adapter to a free USB connection on your PC using the USB cable provided.

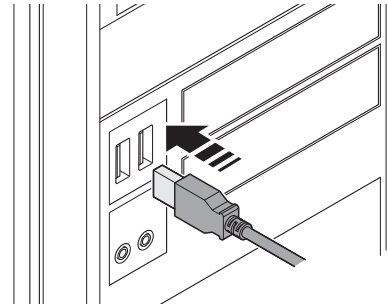

Figure 2 Connection to the PC

4.3 Connection to the device

On the device, connect the programming adapter to the 12-pos. S-PORT interface.

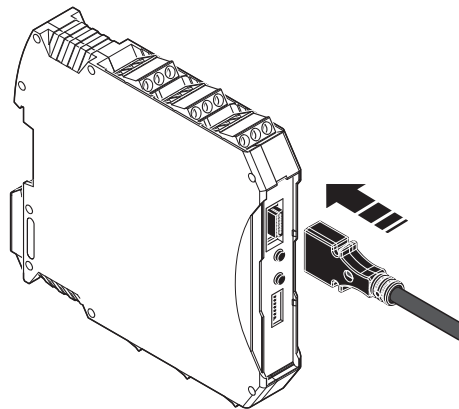

Figure 3 Connection to the device



NOTE: Potential damage to cables

Position the programming adapter so that no strain is placed on the plug-in connection on the device.



To simultaneously parameterize up to 32 EMM devices, which are connected to a gateway via the TBUS, connect the IFS-USB-PROG-ADAPTER (Order No. 2811271) or the data cable IFS-USB-DATACABLE (Order No. 2320500) to the gateway.

5 Software installation

1. Download the “IFS-CONF-SUITE-INTERFACE Setup” software from the URL phoenixcontact.net/products
2. Run the installation file by double-clicking it.
3. Follow the instructions in the installation program until it comes to selecting the software to be installed.

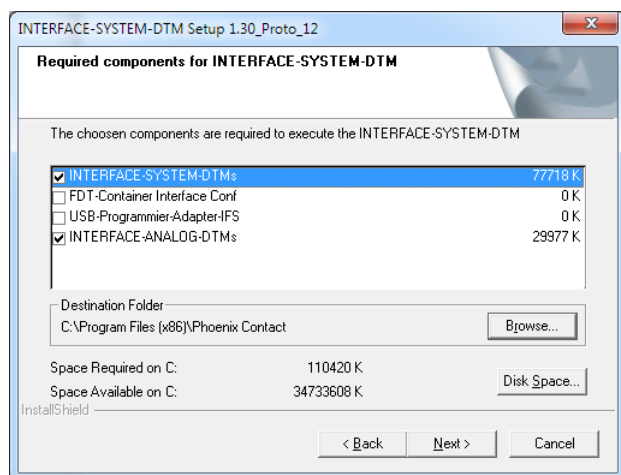

Figure 4 Installation wizard

All options are installed as standard. The following descriptions stipulate that Phoenix Contact's own FDT frame application (FDT container IFS-CONF) is installed and used.



Only Phoenix Contact DTMs can be integrated into Phoenix Contact's own FDT frame application (FDT container IFS-CONF). In addition, available FDT frame applications, such as M&M (see phoenixcontact.net/products), are able to manage any DTMs from various manufacturers.

5.1 Starting the application

Start the application by double-clicking the icon.



Figure 5 Software icon

6 Software configuration

6.1 Initial startup

When starting the IFS-CONF application for the first time, you must set up an administrator.

Additional users can be set up within the application under “Tools, User management”.



Select the “Use Windows login for this user” checkbox if you wish to log in as standard with this user name each time the application starts. In this case, you will not be prompted for your password when the application starts, as authentication has already taken place through the Windows login. This setting is not recommend for an administrator.

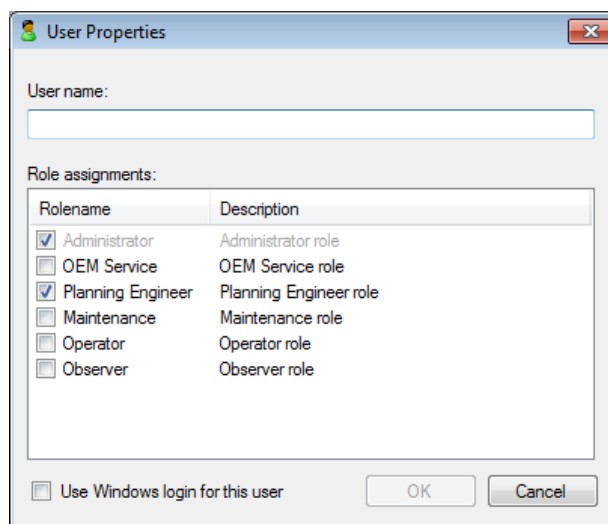

Figure 6 Creating a user when starting the software for the first time

6.2 Transferring CONTACTRON-DTM-IFS to catalog management

After you have created the user, DTM catalog management opens automatically.

Click on “Search for installed DTMs”.

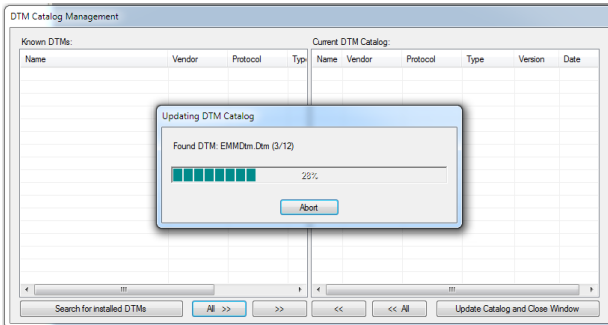

Figure 7 Searching for known DTMs

Any DTMs found on the system are then displayed in the left-hand table under “Known DTMs”. Transfer all desired DTMs to the current DTM catalog.

To do this, proceed as follows:

Select the DTM or several DTMs simultaneously and click on the “>>” button or transfer all the DTMs by clicking on “All >>”.

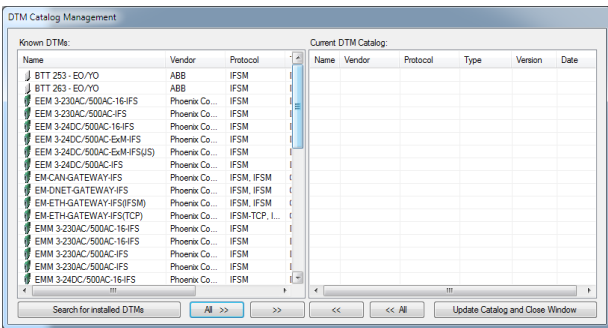

Figure 8 Displaying known DTMs

All desired DTMs are displayed in the current DTM catalog. If you want to transfer additional DTMs at a later time, follow the same procedure.

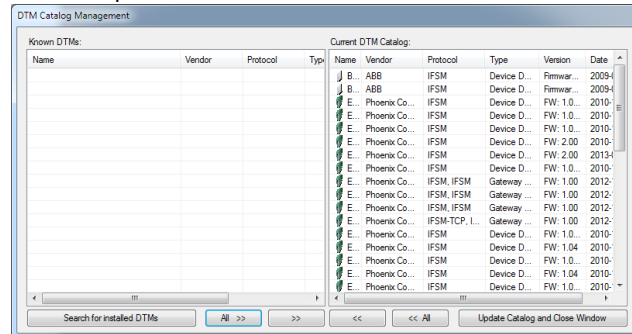

Figure 9 DTM catalog management

Click the “Close” button. All DTMs are now prepared for use in the current DTM catalog.

Catalog management is closed.

6.3 Topology scan

Press the “IFSMGwChannel” button to manually start the topology scan wizard and search for connected devices.

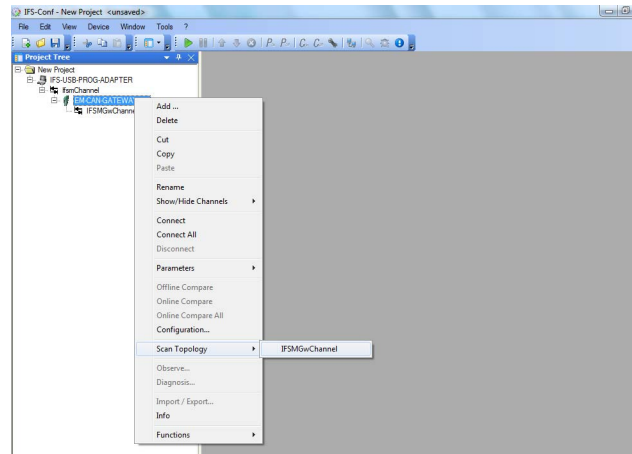

Figure 10 Topology scan

The device search is in progress.

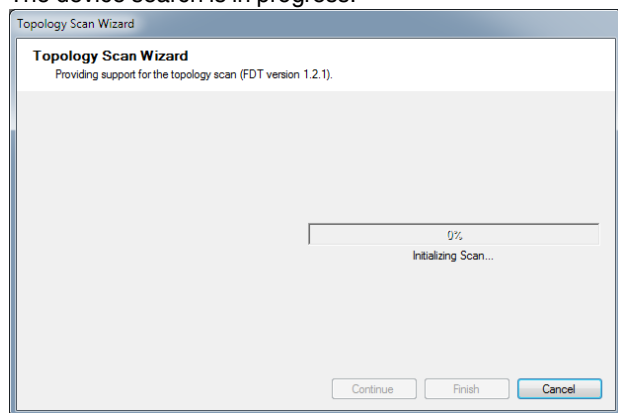

Figure 11 Topology Scan Wizard

Any modules found are displayed in the project tree.

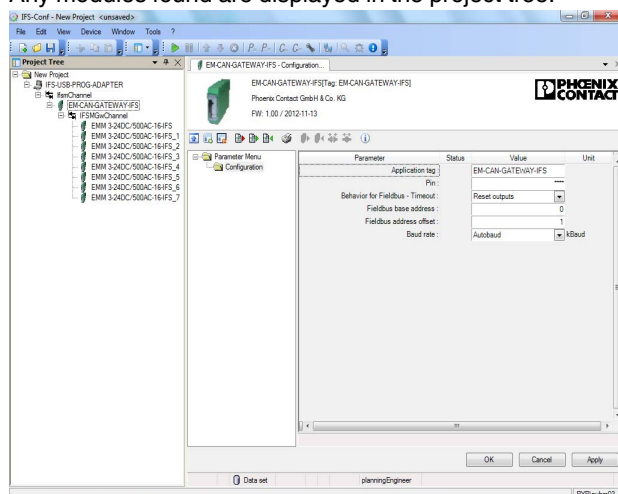

Figure 12 Project tree

6.4 Connecting several devices via an IFS gateway

If several devices, which have not been assigned a unique IFS address, are connected to a gateway via the TBUS, you can cancel the topology scan, as the devices connected to the gateway are not initially displayed in the project tree.

6.5 Functions

Under the “Functions” menu item, you can manage devices connected to the gateway and configure process values.

Device management

In order to identify all the devices on the bus, open the gateway device management by right-clicking the mouse on “Functions, Device management”.

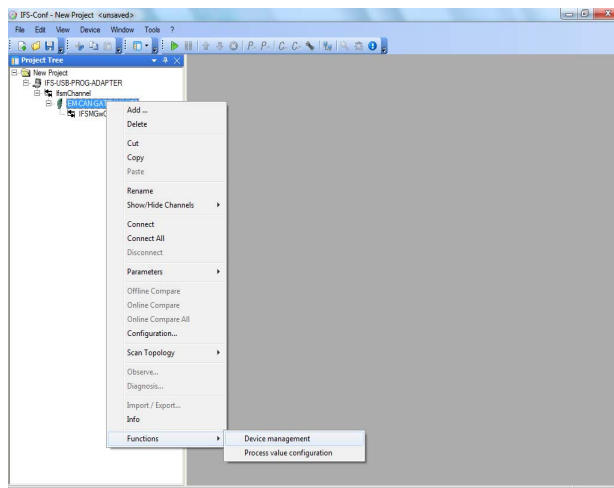

Figure 13 Opening device management

Press the “Connect” button to establish a connection to the gateway.

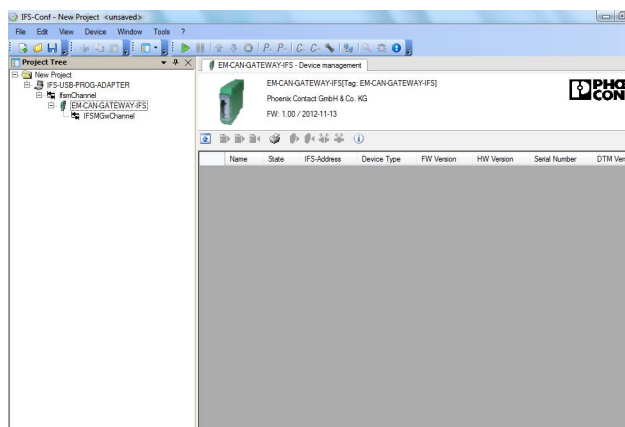

Figure 14 Device management

Following connection, the button in the project tree is highlighted green.

Then click on the “Refresh” button to read the hardware structure.

Interface system gateways and digital extension modules

6.6 Options

The simplest way to assign each device is to select an individual name for every device under “Tools, Options”.

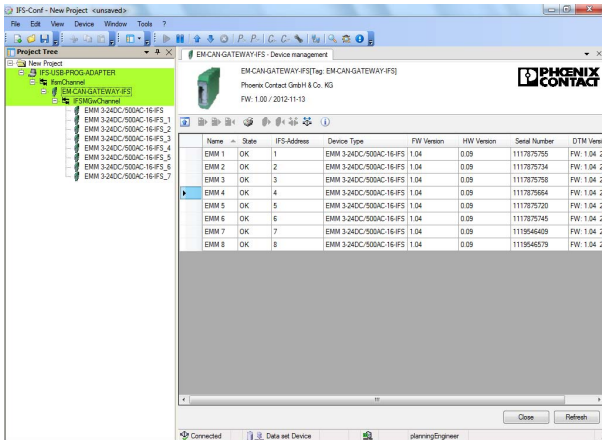

Figure 15 Reading the hardware structure

Assign an IFS address and name to each connected device and then write this information to the devices. To do so, right-click on the gateway in the project tree in the parameter menu on “Download All Parameters”.

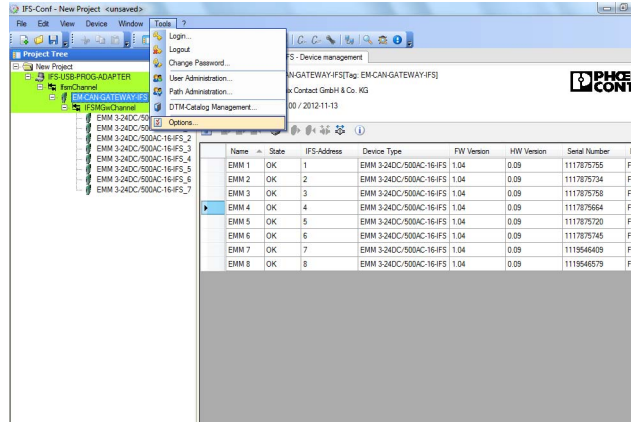

Figure 17 Selecting “Options”

Selecting “Individual Name (Fdt: Tag)”.

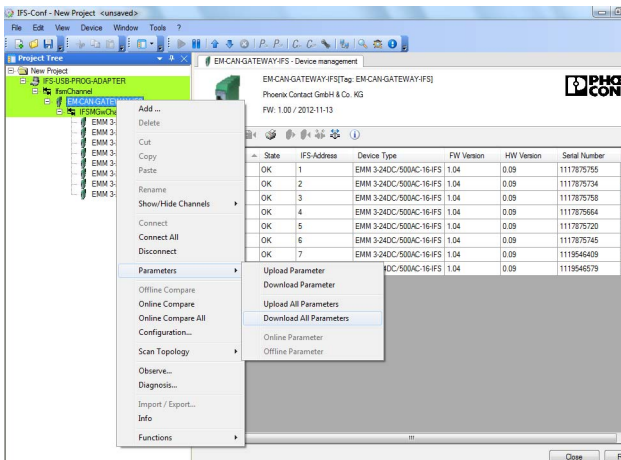

Figure 16 Downloading parameters

The devices are then highlighted green. If addresses have already been assigned to IFS devices, you merely need to change the device names.

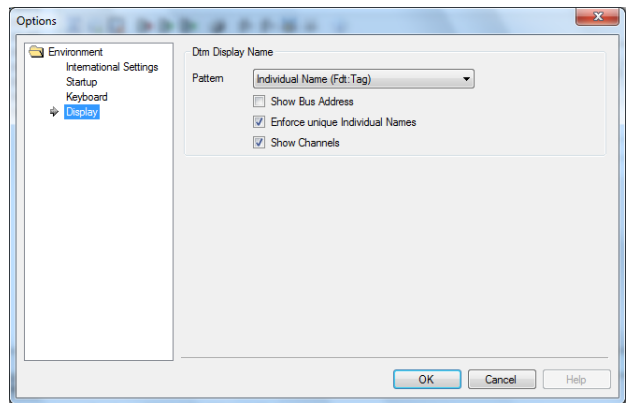

Figure 18 “Individual Name” options

7 Process data configuration

The process data configuration determines which data should be exchanged between the gateway and the control level. In addition to control signals and status messages as inputs, this data can also be measured values of connected devices. Process data can be selected by means of drag and drop.

To do so, open the process data configuration by right-clicking on the gateway in the project tree under “Functions, Process value configuration”.

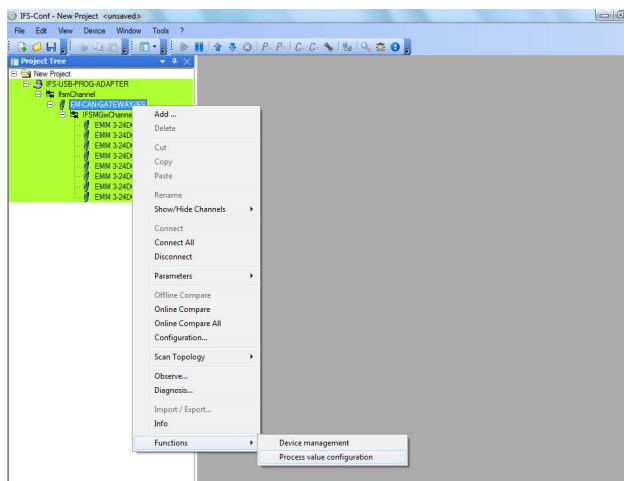

Figure 19 Process data configuration

7.1 Definition of process data

Here you can view and define the process data that can be assigned to each device.

Select the device.

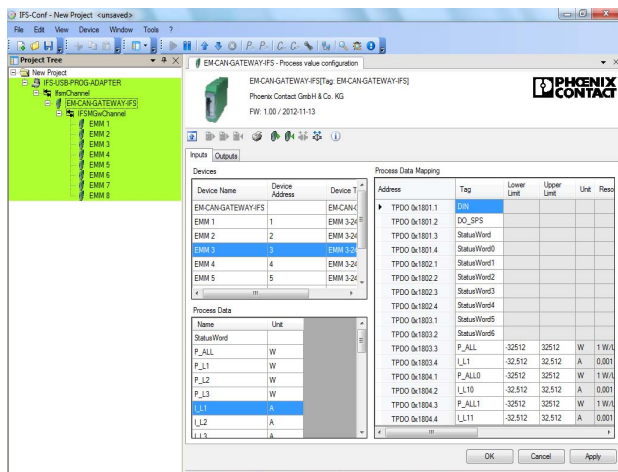

Figure 20 Device selection

Select either “Inputs” or “Outputs”.

Select the process data required by “double-clicking” it.

Click the “Apply” button to apply the process data to the project.

7.2 Downloading process data

To write project data to the modules, right-click with the mouse on the gateway in the project tree and select “Parameters, Download All Parameters”.

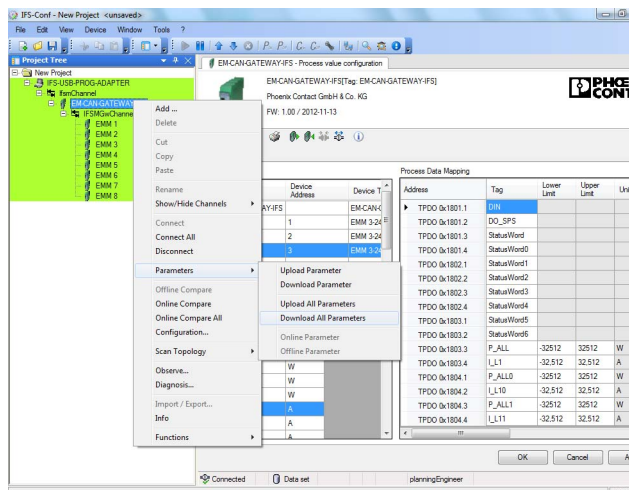

Figure 21 Writing project data to the modules

8 Monitoring dialog box

You can display the cyclically updated process data values of the connected IFS devices, which were assigned in the process data configuration.

The data is displayed in a hexadecimal, binary, and decimal format. The units of the measured values are also displayed.

8.1 Gateways

Right-click on the gateway and then on "Observe".

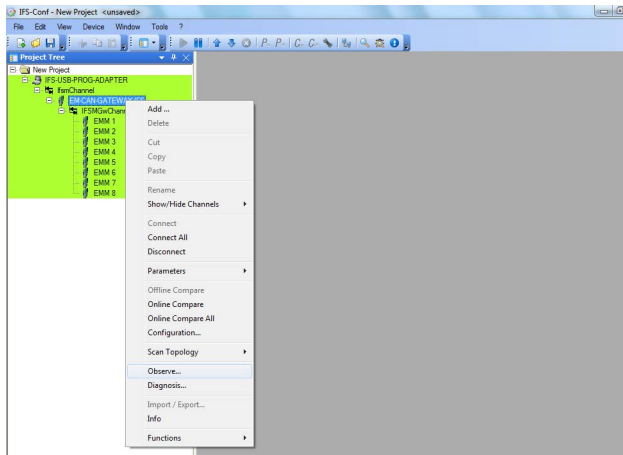

Figure 22 Monitoring

The defined process data is displayed with the corresponding measured values.

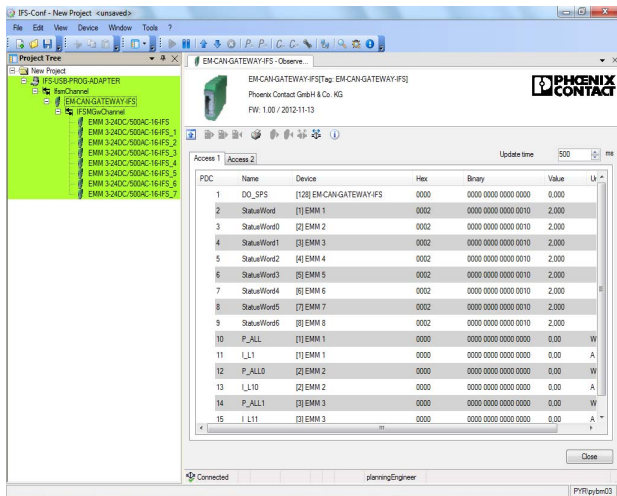

Figure 23 Displaying process values in the monitoring window

8.2 Digital extension modules

Right-click on the gateway and then on "Observe".

The „Overview“ page is displayed.

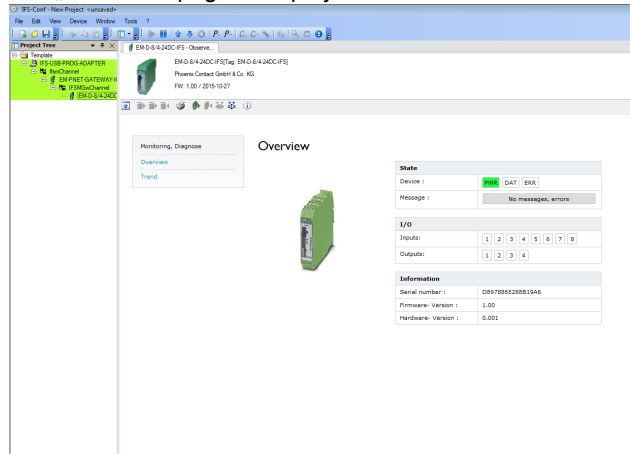

Figure 24 Status overview

The „Trend“ page shows the states of the digital inputs and outputs.

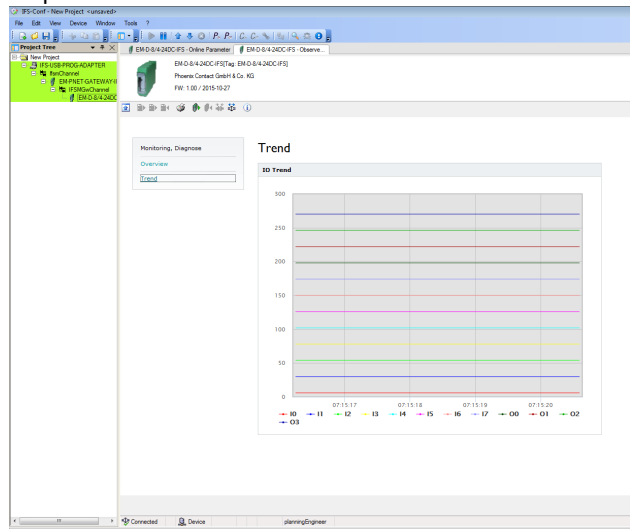

Figure 25 State indication of the digital inputs and outputs

9 Settings

To set the IFS device properties, such as fieldbus address and baud rate, right-click on the gateway and then left-click on “Settings”.

Set the required properties, such as baud rate and fieldbus address. For optimum performance, we recommend defining a fixed baud rate and not selecting Autobaud.

Click the “Apply” button to apply the data to the project.

9.1 CAN gateway EM-CAN-GATEWAY-IFS

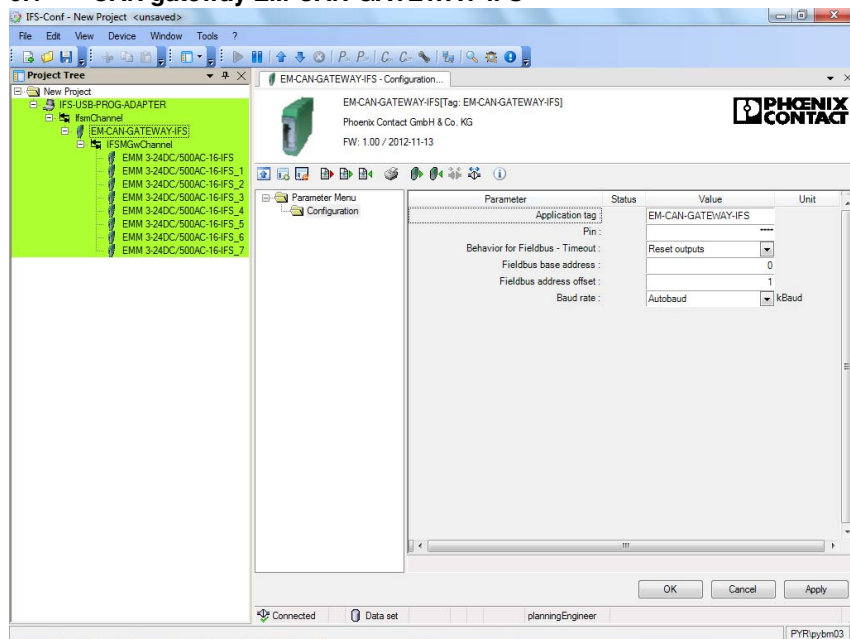

Figure 26 CAN gateway settings

Parameter	Selection	Interval	Program side
Application tag	– Max. 32 characters	–	EM-CAN-GATEWAY-IFS
Pin	– Min: 0 – Max: 9999	–	0000
Behavior for fieldbus timeout	– Reset outputs – Maintain last state	–	Reset outputs
Fieldbus base address	– Min: 0 – Max: 255	1	0
Fieldbus address offset	– Min: 0 – Max: 255	1	10
Baud rate	– Autobaud – 10 – 20 – 50	–	Autobaud

9.2 Ethernet gateway EM-ETH-GATEWAY-IFS

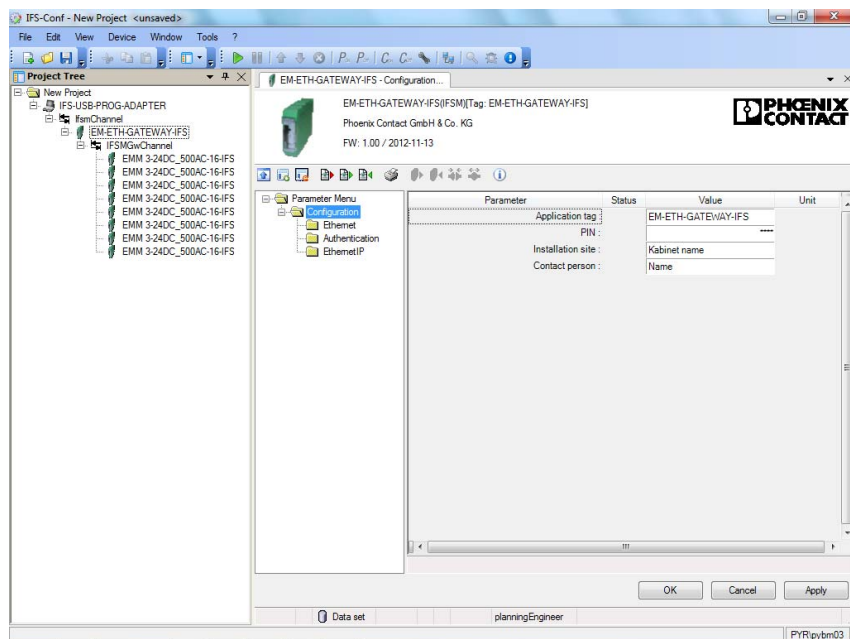

Figure 27 ETH gateway - configuration settings

Parameter	Selection	Interval	Program side
Application tag	– Max. 32 characters	–	EM-ETH-GATEWAY-IFS
PIN	– Min: 0 – Max: 9999	–	0000
Installation site	– Max. 32 characters	–	Kabinet name
Contact person	– Max. 32 characters	–	Name

Interface system gateways and digital extension modules

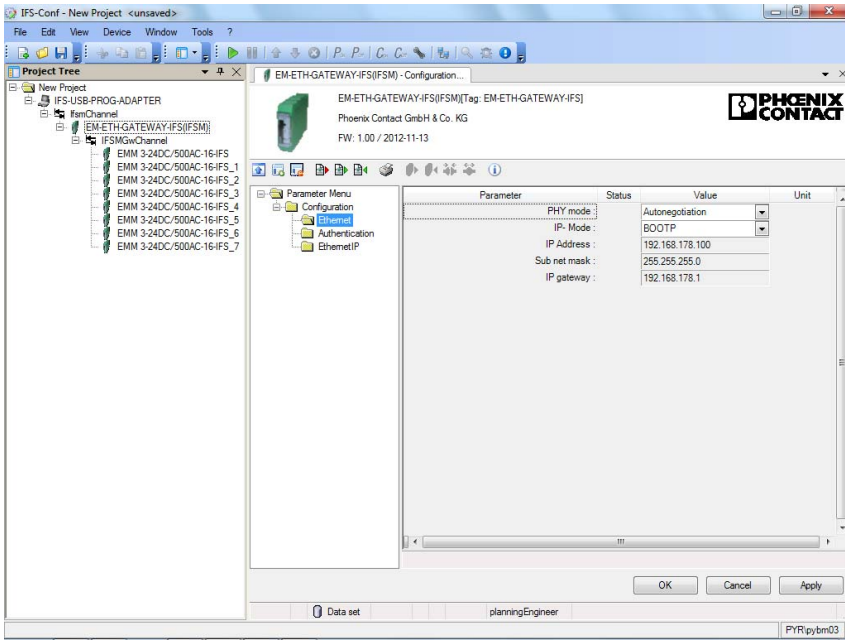

Figure 28 ETH gateway - Ethernet settings

Parameter	Selection	Interval	Program side
PHY mode	<ul style="list-style-type: none"> - Autonegotiation - 10 Mbit, full duplex - 100 Mbit, half duplex - 100 Mbit, full duplex 	-	Autonegotiation
IP Mode	<ul style="list-style-type: none"> - BOOTP - Static IP address - DHCP 	-	BOOTP
IP Address	-	-	192.168.178.100
Sub net mask	-	-	255.255.255.000
IP gateway	-	-	192.168.178.001

Interface system gateways and digital extension modules

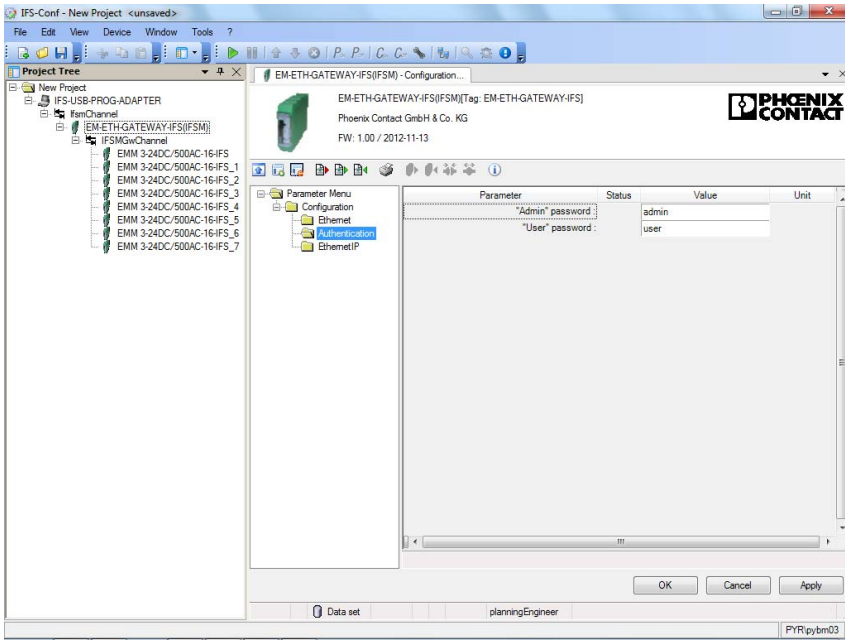

Figure 29 ETH gateway - authentication settings

Parameter	Selection	Interval	Program side
Admin password	- Max. 32 characters	-	admin
User password	- Max. 32 characters	-	user

Interface system gateways and digital extension modules

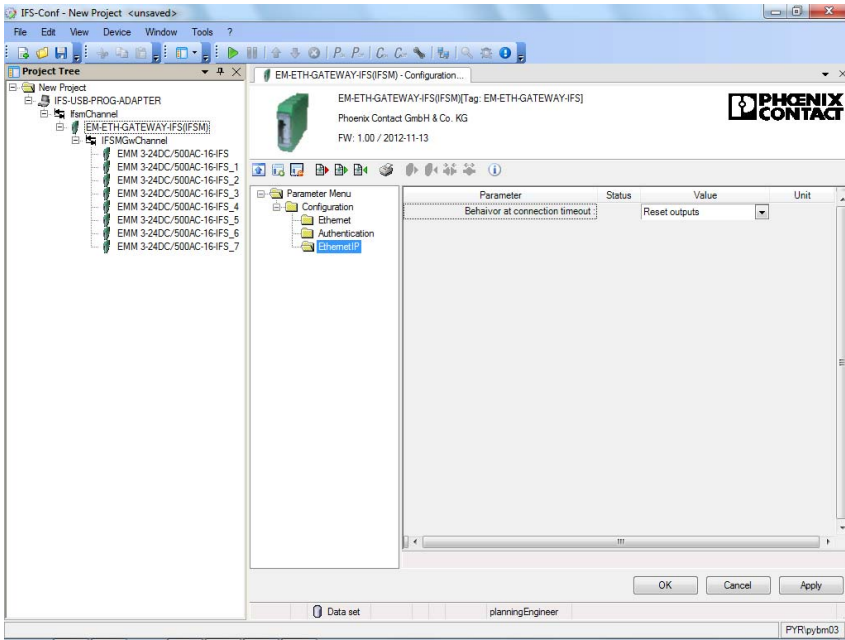

Figure 30 ETH gateway - Modbus/TCP settings

Parameter	Selection	Interval	Program side
Behavior at connection timeout	<ul style="list-style-type: none"> - Reset outputs - Hold last outputs 	-	Reset outputs

9.3 RS-232 gateway EM-RS232-GATEWAY-IFS

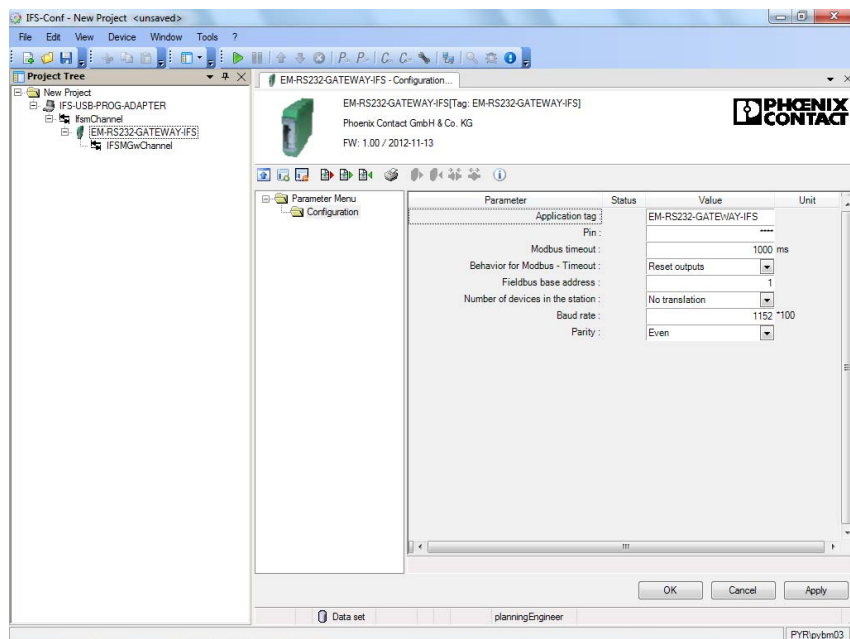

Figure 31 RS-232 gateway settings

Parameter	Selection	Interval	Program side
Application tag	- Max: 32 characters	-	EM-RS232-GATEWAY-IFS
Pin	- Min: 0 - Max: 9999	-	0000
Modbus timeout	- Min: 0 - Max: 60000	1	1000
Behavior for Modbus-Timeout	- Reset outputs - Maintain last state	-	Reset outputs
Fieldbus base address	- Min: 0 - Max: 255	1	1
Number of devices in the station	- No translation - 1 - 3 - 7 - 15 - 31	-	No translation
Baud rate	- Min: 96 - Max: 30000	1	1152
Parity	- None - Even - Odd	-	Even

9.4 RS-485 gateway EM-RS485-GATEWAY-IFS

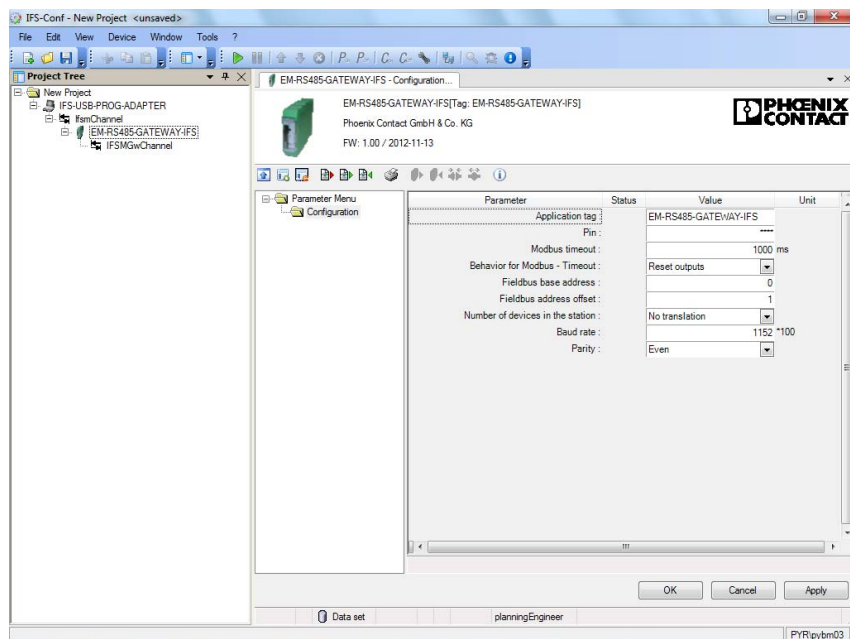

Figure 32 RS-485 gateway settings

Parameter	Selection	Interval	Program side
Application tag	- Max. 32 characters	-	EM-RS485-GATEWAY-IFS
Pin	- Min: 0 - Max: 9999	-	0000
Modbus timeout	- Min: 0 - Max: 60000	1	1000
Behavior for Modbus-Timeout	- Reset outputs - Maintain last state	-	Reset outputs
Fieldbus base address	- Min: 0 - Max: 255	1	0
Fieldbus address offset	- Min: 0 - Max: 255	1	1
Number of devices in the station	- No translation - 1 - 3 - 7 - 15 - 31	-	No translation
Baud rate	- Min: 96 - Max: 30000	1	1152

Interface system gateways and digital extension modules

Parameter	Selection	Interval	Program side
Parity	- None - Even - Odd	-	Even

9.5 PROFIBUS gateway EM-PB-GATEWAY-IFS

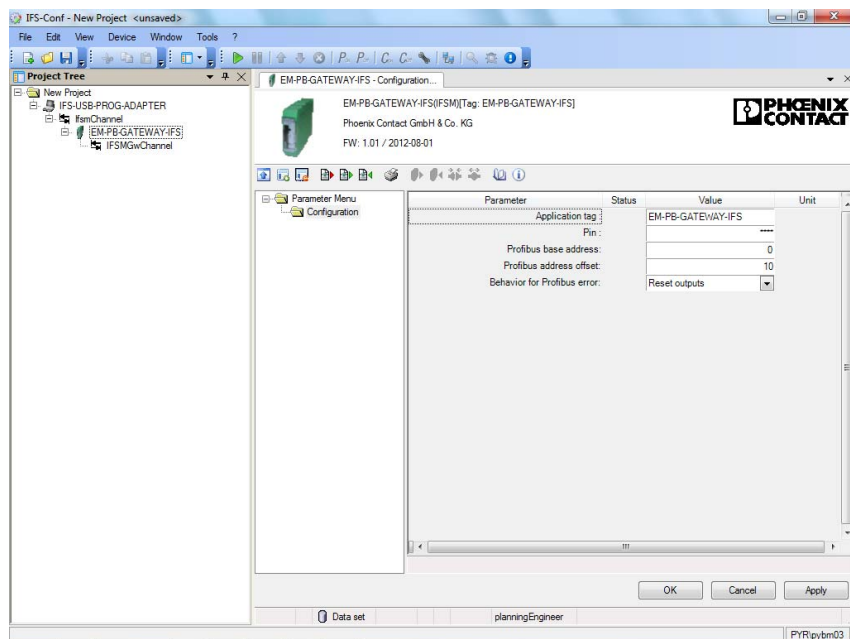

Figure 33 Settings EM-PB-GATEWAY-IFS

Parameter	Selection	Interval	Program side
Application tag	- Max: 32 characters	-	EM-PB-GATEWAY-IFS
Pin	- Min: 0 - Max: 9999	-	0000
Profibus base address	- Min: 0 - Max: 96	1	0
Profibus address offset	- Min: 0 - Max: 31	1	10
Behavior for Profibus error	- Reset outputs - Maintain last state	-	Reset outputs

9.6 PROFINET gateway EM-PNET-GATEWAY-IFS

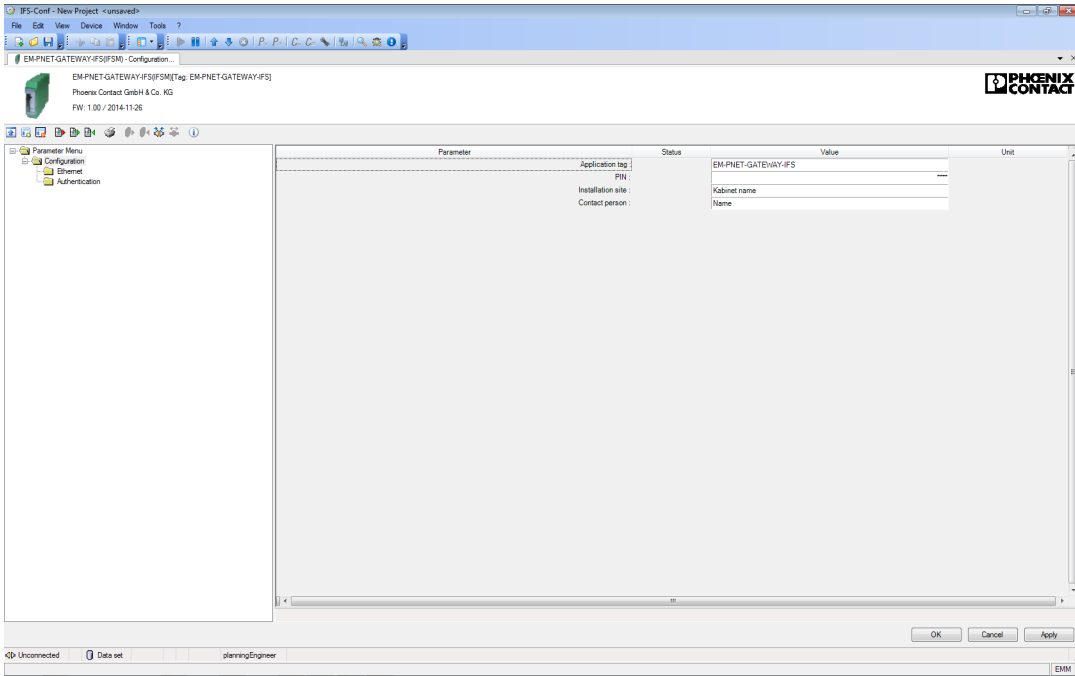

Figure 34 PROFINET gateway - configuration settings

Parameter	Selection	Interval	Program side
Application tag	- Max. 32 characters	-	EM-PNET-GATEWAY-IFS
PIN	- Min: 0 - Max: 9999	-	0000
Installation site	- Max. 32 characters	-	Kabinet name
Contact person	- Max. 32 characters	-	Name

Interface system gateways and digital extension modules

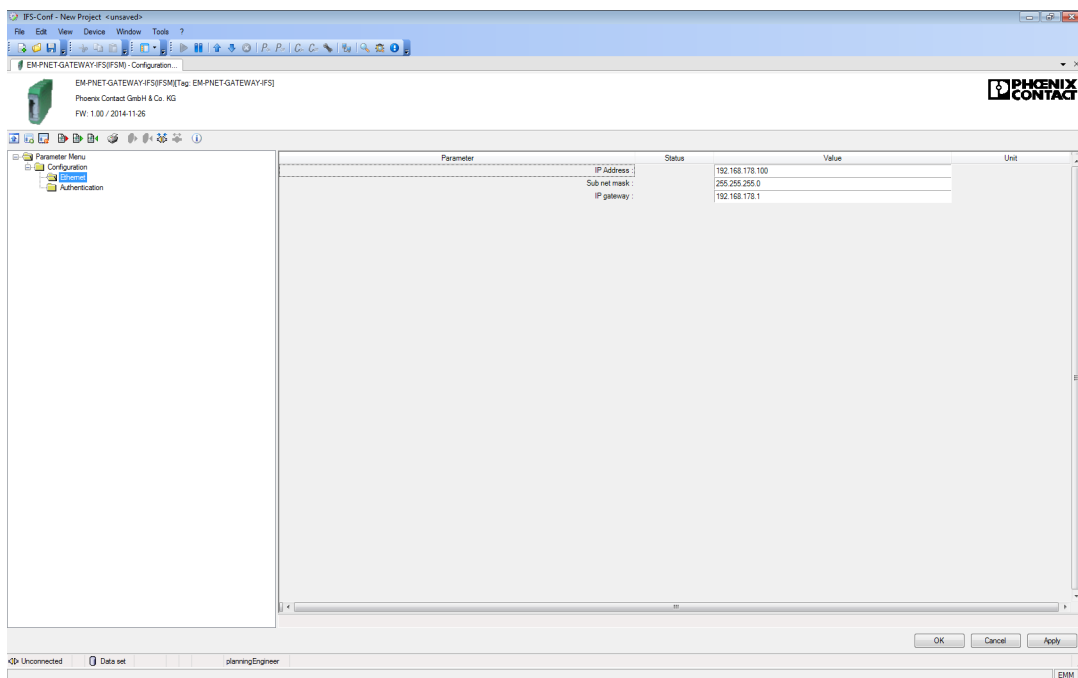

Figure 35 PROFINET gateway - Ethernet settings

Parameter	Selection	Interval	Program side
IP Address	–	–	192.168.178.100
Sub net mask	–	–	255.255.255.0
IP gateway	–	–	192.168.178.1

Interface system gateways and digital extension modules

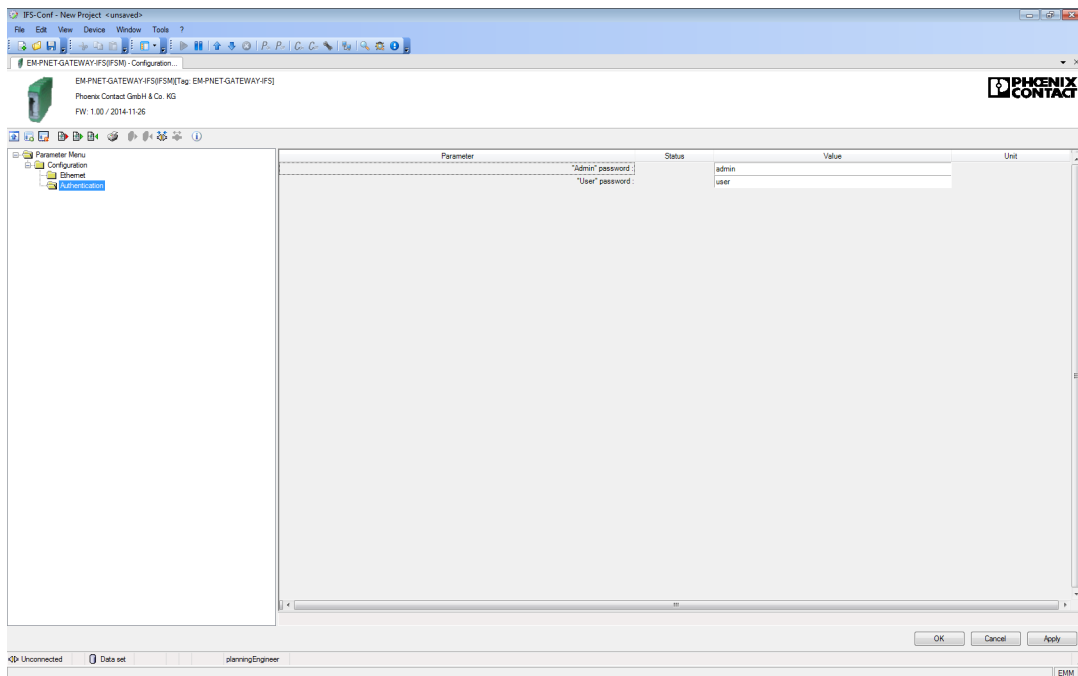

Figure 36 PROFINET gateway - authentication settings

Parameter	Selection	Interval	Program side
Admin password	– Max. 32 characters	–	admin
User password	– Max. 32 characters	–	user

9.7 Modbus gateway EM-MBUS-GATEWAY-IFS

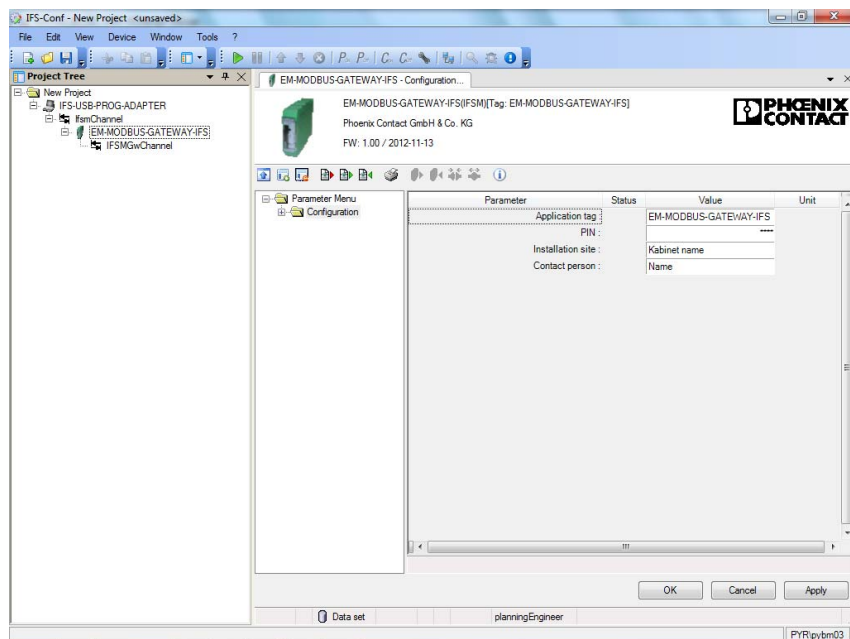

Figure 37 Modbus gateway - configuration settings

Parameter	Selection	Interval	Program side
Application tag	- Max. 32 characters	-	EM-MBUS-GATEWAY-IFS
PIN	- Min: 0 - Max: 9999	-	0000
Installation site	- Max. 32 characters	-	Kabinet name
Contact person	- Max. 32 characters	-	Name

Interface system gateways and digital extension modules

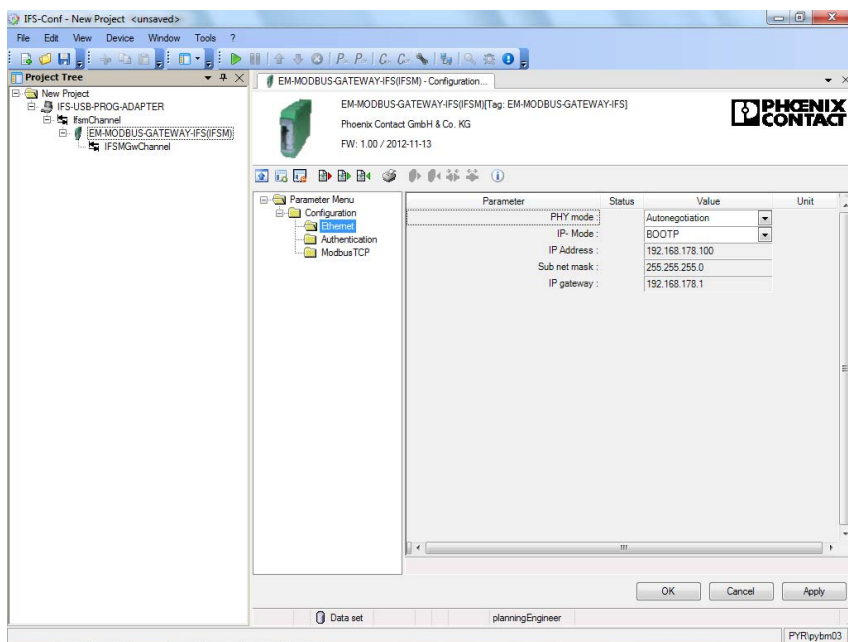

Figure 38 Modbus gateway - Ethernet settings

Parameter	Selection	Interval	Program side
PHY mode	<ul style="list-style-type: none"> - Autonegotiation - 10 Mbit, full duplex - 100 Mbit, half duplex - 100 Mbit, full duplex 	-	Autonegotiation
IP-Mode	<ul style="list-style-type: none"> - BOOTP - Static IP address - DHCP - DHCP or AutoIP 	-	BOOTP
IP Address	-	-	192.168.178.100
Sub net mask	-	-	255.255.255.000
IP gateway	-	-	192.168.178.001

Interface system gateways and digital extension modules

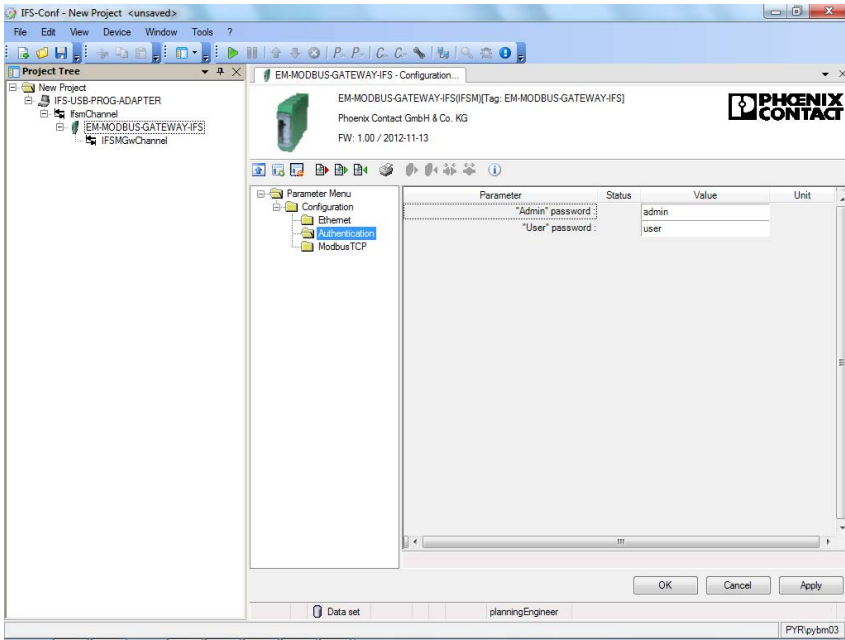

Figure 39 Modbus gateway - authentication settings

Parameter	Selection	Interval	Program side
Admin password	- Max. 32 characters	-	admin
User password	- Max. 32 characters	-	user

Interface system gateways and digital extension modules

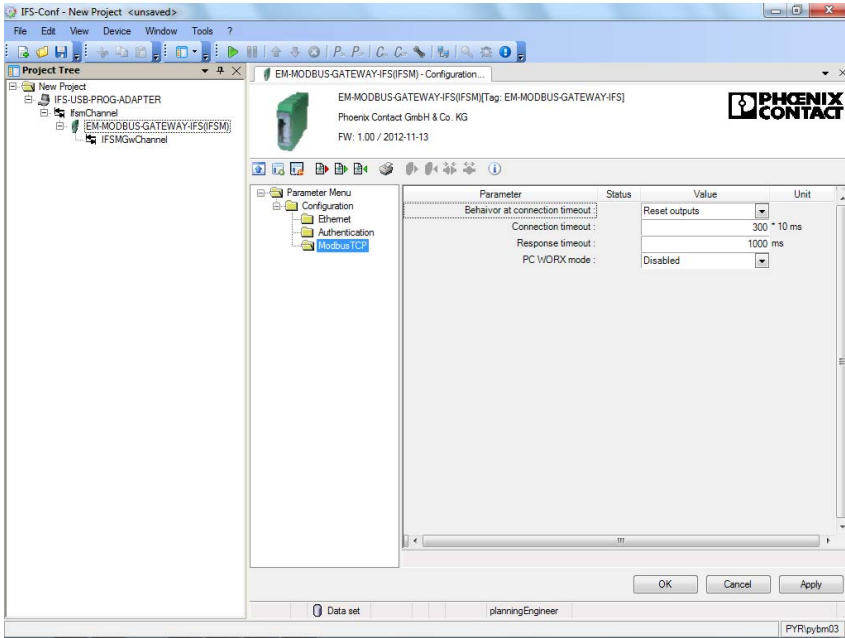

Figure 40 Modbus gateway - Modbus/TCP settings

Parameter	Selection	Interval	Program side
Behavior at connection timeout	<ul style="list-style-type: none"> - Reset outputs - Maintain last state 	-	Reset outputs
Connection timeout	<ul style="list-style-type: none"> - Min: 100 - Max: 6000 	-	3000 ms
Response timeout	<ul style="list-style-type: none"> - Min: 50 - Max: 60000 	-	1000 ms
PC WORX mode	<ul style="list-style-type: none"> - Disabled - Enabled 	-	Disabled

9.8 DeviceNet gateway EM-DNET-GATEWAY-IFS

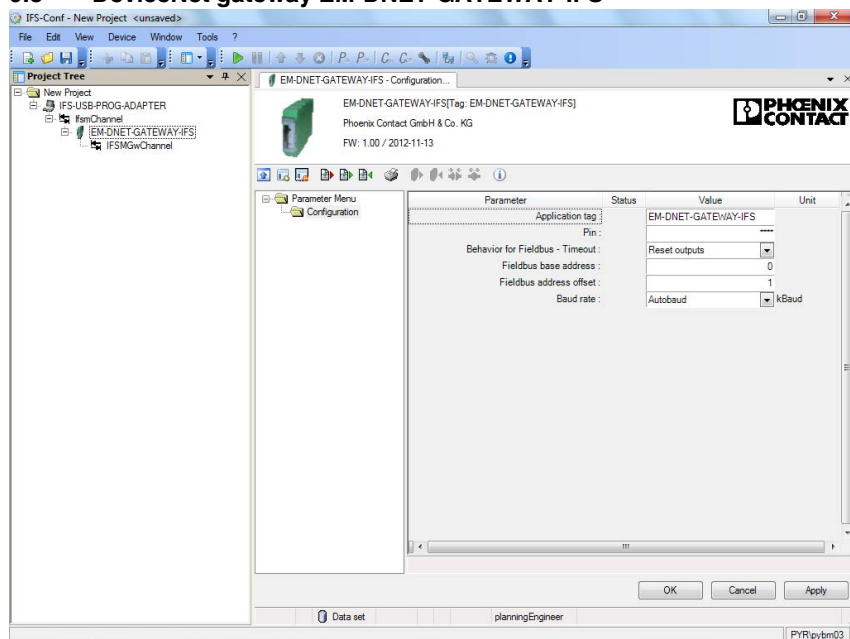

Figure 41 DeviceNet gateway settings

Parameter	Selection	Interval	Program side
Application tag	- Max. 32 characters	-	EM-DNET-GATEWAY-IFS
Pin	- Min: 0 - Max: 9999	-	0000
Behavior for Fieldbus-Timeout	- Reset outputs - Maintain last state	-	Reset outputs
Fieldbus base address	- Min: 0 - Max: 255	1	0
Fieldbus address offset	- Min: 0 - Max: 255	1	10
Baud rate	- Autobaud - 125 - 250 - 500	-	Autobaud

Interface system gateways and digital extension modules

9.9 Digital extension module EM-D-8/4-24DC-IFS

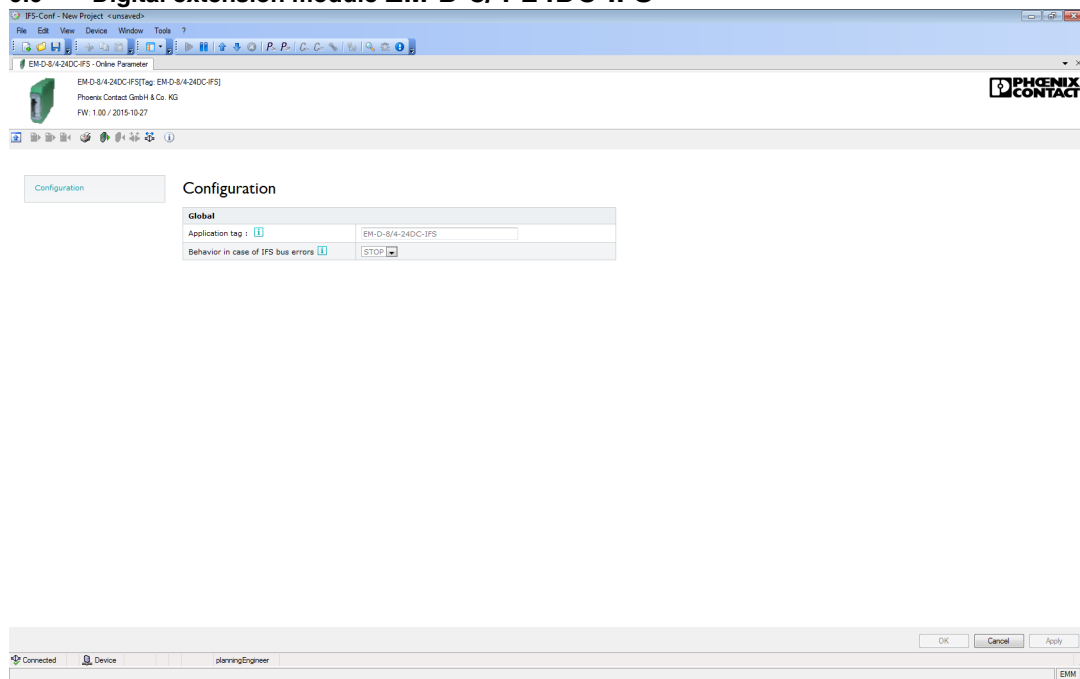

Figure 42 Digital extension module settings

Parameter	Selection	Interval	Program side
Application tag	- Max. 32 characters	-	EM-D-8/4-24DC-IFS
Behavior in case of IFS bus errors	- Stop - On hold	-	Stop

10 Diagnostics dialog box

You can continually check the current states of the gateway via the diagnostics dialog box. In addition, IFS communication errors can be displayed for the individual devices.

To open the dialog box, right-click on the gateway and then on "Diagnostics".

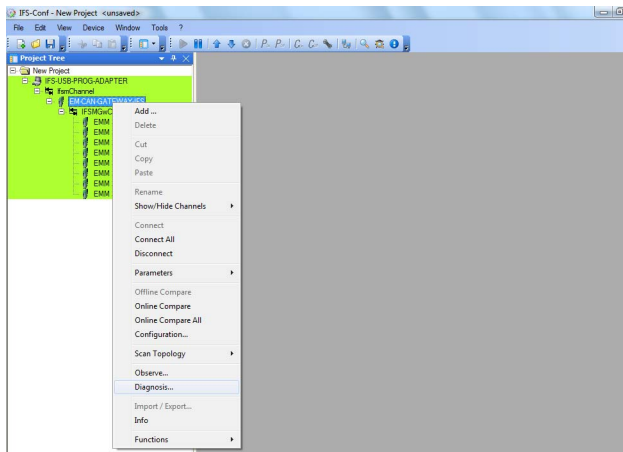

Figure 43 Opening the Diagnostics dialog box

10.1 Overview

The "Overview" dialog box displays all the operating data and status messages that provide initial information. This dialog box enables a quicker and more comprehensive overview of the gateway state.

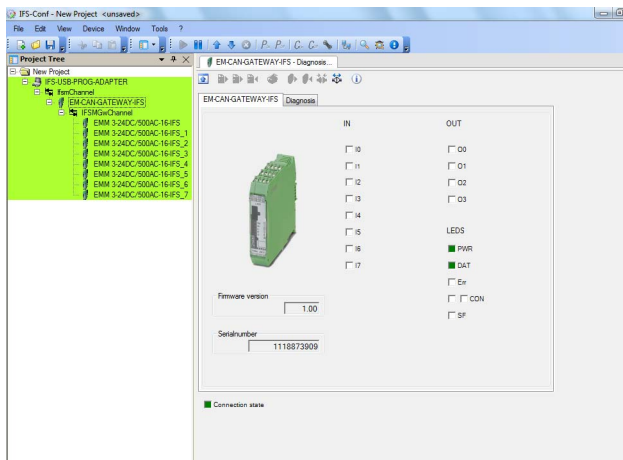

Figure 44 Tab 1 of the gateway Diagnostics dialog box

10.2 Diagnostics

The Diagnostics dialog box displays all status messages of the devices connected to the IFS bus. This provides a quick overview of the IFS communication state.

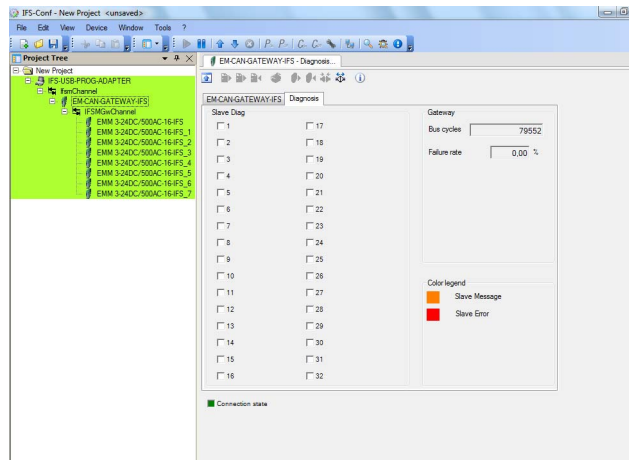

Figure 45 Tab 2 of the gateway Diagnostics dialog box

11 Saving the project

You can save the project for further use of the project data, e.g., for comparable stations. To do so, go to "File, Save as..." and enter a name.

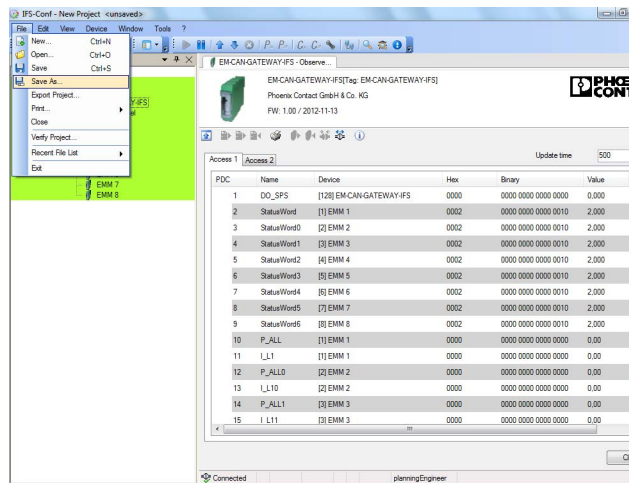

Figure 46 Saving the project



SCATTERGOOD & JOHNSON LTD

ELECTRICAL ENGINEERING & FLUID CONTROL DISTRIBUTORS

Est.1899

At Scattergood & Johnson Ltd, we pride ourselves on being a technical distributor to specialist industries.

Working with a range of quality product suppliers across a number of specialist markets, we are not your average 'box shifter' - we are your technical and supply chain partner.

We fully support every product we sell - for free! Our internal team and external sales engineers can answer any product or application question, no matter the complexity.

Backing up this technical ability is a range of 50,000+ products available from stock for nationwide next day delivery (same day if required!), or you can collect what you need from any of our trade counters around the UK.

Select your specialist interest below to learn more about how we can help.

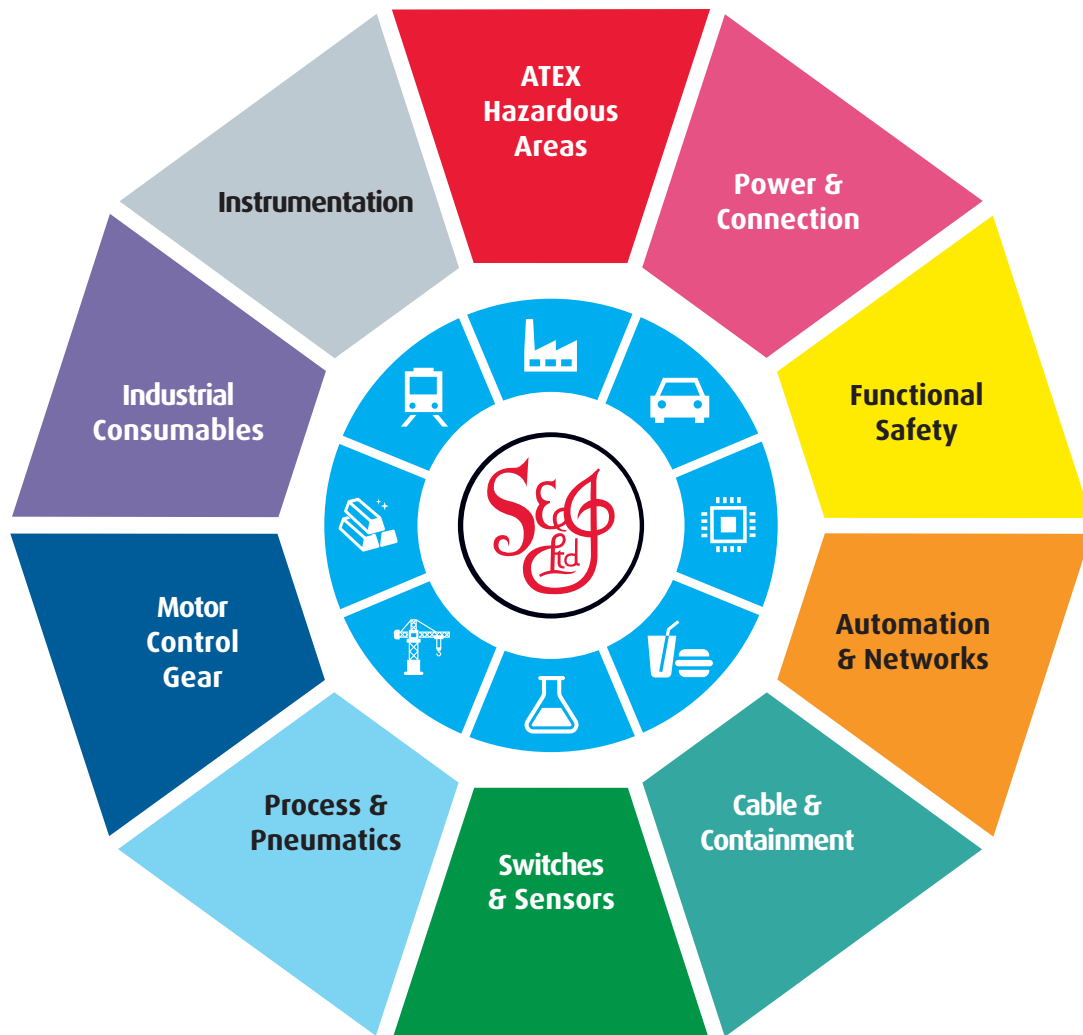

Online, In Branch and On the Road - Scattergood & Johnson Ltd, there when you need us.

www.scatts.co.uk