

## Monitoring relay - EMD-BL-V-230 - 2903523

Please be informed that the data shown in this PDF Document is generated from our Online Catalog. Please find the complete data in the user's documentation. Our General Terms of Use for Downloads are valid (<http://phoenixcontact.com/download>)



Monitoring relay for monitoring 1-phase voltages of 24 V AC/DC or 230 V AC, undervoltage or window, 1 PDT, with screw connection

### Product Description

Safety and system availability requirements are constantly on the increase – across all industries. Processes are becoming more and more complex, not only in machine building and the chemical industry but also in building technology. The demands placed on energy technology are also constantly on the rise.

It is only by continuously monitoring key network and system parameters that error-free and therefore cost-effective operation can be achieved.

Electronic monitoring relays from the EMD series are available for a wide range of monitoring tasks so that the consequences of errors can be avoided or kept within limits.

The operating states are signaled via color LEDs and any errors that occur can be sent to a controller via a floating contact or can shut down a section of the system. All device versions are equipped with response delays so that measured values outside the set monitoring range can be briefly tolerated.



### Key Commercial Data

Packing unit	1 pc
GTIN	 4 046356 747271
GTIN	4046356747271
Weight per Piece (excluding packing)	80.000 g
Custom tariff number	85364900
Country of origin	Austria

### Technical data

#### Dimensions

Width	17.5 mm
Height	88 mm
Depth	65.5 mm

#### Ambient conditions

## Monitoring relay - EMD-BL-V-230 - 2903523

### Technical data

#### Ambient conditions

Ambient temperature (operation)	-25 °C ... 55 °C
Ambient temperature (storage/transport)	-25 °C ... 70 °C
Permissible humidity (operation)	15 % ... 85 %
Degree of protection	IP40 (Housing)
	IP20 (Connection terminal blocks)
Noise immunity	EN 61000-6-2

#### Input data

Input voltage range	0 V DC ... 24 V DC (connection terminal blocks: U1 and GND)
	0 V AC ... 24 V AC (connection terminal blocks: U2 and GND)
	0 V AC ... 230 V AC (connection terminal blocks: U3 and GND)
Maximum temperature coefficient	≤ 0.05 %
Function	Undervoltage, window
Min. setting range	75 % ... 115 % (From U <sub>N</sub> )
Max. setting range	80 % ... 120 % (From U <sub>N</sub> )
Setting range for response delay	0.1 s ... 10 s
Basic accuracy	≤ 5 % (of scale end value)
Setting accuracy	± 5 % (of scale end value)
Repeat accuracy	≤ 2 %
Recovery time	> 500 ms

#### Contact side

Contact type	1 floating PDT
Maximum switching voltage	250 V AC (in acc. with IEC 60664-1)
Interrupting rating (ohmic load) max.	1250 VA (5 A / 250 V AC)
Output fuse	5 A (fast-blow)

#### Power supply

Supply voltage	-25 % ... +20 % (= measuring voltage)
----------------	---------------------------------------

#### General

Mechanical service life	15x 10 <sup>6</sup> cycles
Operating mode	100% operating factor
Mounting position	any
Assembly instructions	on standard DIN rail NS 35 in accordance with EN 60715
Electromagnetic compatibility	Conformance with EMC Directive 2004/108/EC
Housing insulation material	Polyamide PA 6.6, self-extinguishing
Color	gray

#### Connection data

## Monitoring relay - EMD-BL-V-230 - 2903523

### Technical data

#### Connection data

Connection method	Screw connection
Stripping length	8 mm
Conductor cross section solid	0.5 mm <sup>2</sup> ... 2.5 mm <sup>2</sup>
Conductor cross section flexible	0.5 mm <sup>2</sup> ... 2.5 mm <sup>2</sup>
Conductor cross section AWG	20 ... 14
Torque	1 Nm ... 1 Nm

#### Standards and Regulations

Electromagnetic compatibility	Conformance with EMC Directive 2004/108/EC
Noise emission	EN 61000-6-3
Noise immunity	EN 61000-6-2
Standards/regulations	DIN EN 60947-5-1
Rated insulation voltage	300 V (Supply circuit) 250 V (Output circuit)
Rated surge voltage	4 kV
Insulation	Basic insulation
Pollution degree	2
Overvoltage category	III
Low Voltage Directive	Conformance with LV directive 2006/95/EC

#### Environmental Product Compliance

China RoHS	Environmentally friendly use period: unlimited = EFUP-e
	No hazardous substances above threshold values

### Drawings

Block diagram

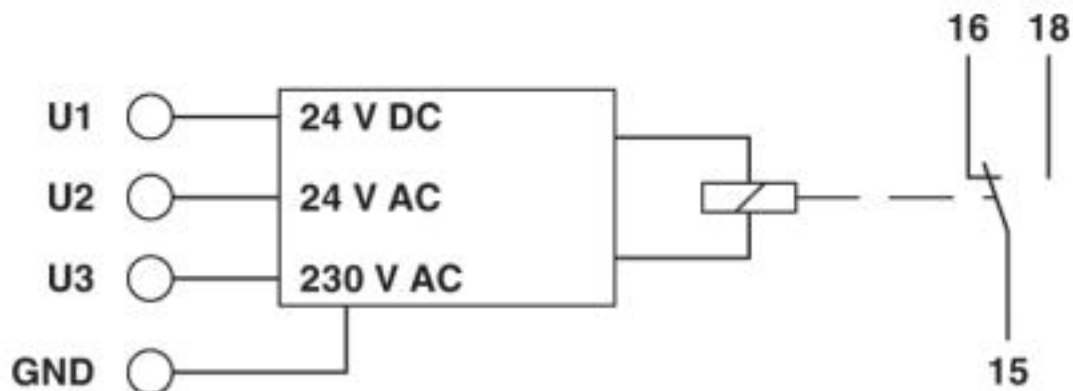

<https://www.phoenixcontact.com/us/products/2903523>

## Monitoring relay - EMD-BL-V-230 - 2903523

### Classifications

#### eCl@ss

eCl@ss 4.0	27371100
eCl@ss 4.1	27371100
eCl@ss 5.0	27371800
eCl@ss 5.1	27371800
eCl@ss 6.0	27371800
eCl@ss 7.0	27371801
eCl@ss 8.0	27371801
eCl@ss 9.0	27371801

#### ETIM

ETIM 2.0	EC001438
ETIM 3.0	EC001438
ETIM 4.0	EC001438
ETIM 5.0	EC001438
ETIM 6.0	EC001438
ETIM 7.0	EC001438

#### UNSPSC

UNSPSC 6.01	30211916
UNSPSC 7.0901	39121535
UNSPSC 11	39121535
UNSPSC 12.01	39121535
UNSPSC 13.2	41113620

### Approvals

#### Approvals

##### Approvals





UL Listed / cUL Listed / EAC / EAC / cULus Listed

##### Ex Approvals

#### Approval details

## Monitoring relay - EMD-BL-V-230 - 2903523

### Approvals

UL Listed		<a href="http://database.ul.com/cgi-bin/XYV/template/LISEXT/1FRAME/index.htm">http://database.ul.com/cgi-bin/XYV/template/LISEXT/1FRAME/index.htm</a>	FILE E 172140
cUL Listed		<a href="http://database.ul.com/cgi-bin/XYV/template/LISEXT/1FRAME/index.htm">http://database.ul.com/cgi-bin/XYV/template/LISEXT/1FRAME/index.htm</a>	FILE E 172140
EAC			TR_TS_D_00573_c
EAC			TR_TS_S_00010_c
cULus Listed			



# SCATTERGOOD & JOHNSON LTD

ELECTRICAL ENGINEERING & FLUID CONTROL DISTRIBUTORS

Est.1899

At Scattergood & Johnson Ltd, we pride ourselves on being a technical distributor to specialist industries.

Working with a range of quality product suppliers across a number of specialist markets, we are not your average 'box shifter' - we are your technical and supply chain partner.

We fully support every product we sell - for free! Our internal team and external sales engineers can answer any product or application question, no matter the complexity.

Backing up this technical ability is a range of 50,000+ products available from stock for nationwide next day delivery (same day if required!), or you can collect what you need from any of our trade counters around the UK.

Select your specialist interest below to learn more about how we can help.



Online, In Branch and On the Road - Scattergood & Johnson Ltd, there when you need us.

# [www.scatts.co.uk](http://www.scatts.co.uk)