



# Application manual for PSRclassic and PSRmultifunction safety relays, and the modular safety relay system

User manual

## **User manual**

# **Application manual for PSRclassic and PSRmultifunction safety relays, and the modular safety relay system**

UM EN SAFETY RELAY APPLICATION, Revision 03

2019-04-04

---

This user manual is valid for:

Phoenix Contact PSRclassic and PSRmultifunction safety relays, and the modular safety relay system

102597\_en\_03

# Table of contents

1	Introduction .....	7
1.1	Target group for this application manual .....	7
1.2	Symbols used .....	8
1.3	Further documentation .....	8
2	Safety of machines and systems .....	9
2.1	Functional safety .....	10
2.2	Practical procedure in accordance with EN ISO 13849 .....	10
2.2.1	Definition of the safety function .....	10
2.2.2	Determination of the required performance level (PL <sub>r</sub> ) .....	11
2.2.3	Technical implementation .....	11
2.2.4	Determination of the achieved PL for each subsystem .....	12
2.2.5	Determination of the achieved PL for the overall safety function .....	14
2.2.6	Verification of the achieved PL .....	14
2.2.7	Validation .....	14
2.3	Practical procedure in accordance with EN ISO 62061 .....	15
2.3.1	Specification of requirements for the safety-related control function (SRCF) .....	15
2.3.2	Determination of the required safety integrity level (SIL) .....	15
2.3.3	Drafting the safety-related electrical control system (SRECS) .....	15
2.3.4	Dividing the safety function into subsystems .....	16
2.3.5	Determination of the achieved safety integrity for the entire SRECS ....	18
2.3.6	Verification of the achieved SIL .....	18
2.3.7	Validation .....	19
3	Safety technology basics .....	21
3.1	Cross-circuit detection .....	21
3.2	Maximum cable lengths .....	22
3.3	Stop .....	24
3.4	Safe isolation .....	26
4	Overview of safe switching devices .....	27
4.1	Conventional safety relays PSRclassic.....	27
4.2	Multifunctional safety relays PSRmultifunction .....	29
4.3	Modular safety relay system .....	30

## Application manual for PSRclassic and PSRmultifunction, and the modular safety relay system

<b>5</b>	<b>Application examples for conventional PSRclassic safety relays</b>	<b>31</b>
5.1	Emergency stop	31
5.1.1	PSR-ESL4/3x1/1x2/B up to PL c/SIL 1	32
5.1.2	PSR-ESD/4x1/30 up to PL c/SIL 1	34
5.1.3	PSR-ESAM4/2x1/1x2 up to PL e/SIL 3	36
5.1.4	PSR-ESL4/3x1/1x2/B up to PL d/SIL 2	38
5.1.5	PSR-ESAM4/8x1/1x2 up to PL e/SIL 3	40
5.1.6	PSR-ESD/4x1/30 up to PL e/SIL 3	42
5.1.7	PSR-ESAM4/3x1/1x2/B up to PL e/SIL 3	44
5.2	Light grids (ESPE)/laser scanners (AOPD)	47
5.2.1	PSR-ESL4/3x1/1x2/B up to PL e/SIL 3	48
5.2.2	PSR-ESD/4x1/30 up to PL e/SIL 3	50
5.2.3	PSR-ESAM4/8x1/1x2 up to PL e/SIL 3	52
5.2.4	PSR-ESD/4x1/30 up to PL d/SIL 2	54
5.3	Movable guards	57
5.3.1	PSR-ESA4/2x1/1x2 up to PL e/SIL 3	58
5.3.2	PSR-ESAM4/2x1/1x2 up to PL e/SIL 3	60
5.3.3	PSR-ESAM4/3x1/1x2 up to PL e/SIL 3	62
5.3.4	PSR-ESAM4/3x1/1x2/B up to PL d/SIL 2	64
5.3.5	PSR-ESD/4x1/30 up to PL c/SIL 1	66
5.3.6	PSR-ESD/4x1/30 up to PL e/SIL 3	68
5.3.7	PSR-ESD/5x1/1x2/300 up to PL e/SIL 3	70
5.3.8	PSR-ESL4/3x1/1x2/B up to PL d/SIL 2	72
5.4	Enable switch	75
5.4.1	PSR-ESAM4/2x1/1x2 up to PL e/SIL 3	76
5.4.2	PSR-ESAM4/3x1/1x2/B up to PL e/SIL 3	78
5.4.3	PSR-ESAM4/2x1/1x2 up to PL e/SIL 3	80
5.5	Two-hand control	83
5.5.1	PSR-THC4/2x1/1x2 up to PL e/SIL 3	84
5.6	Contact extension/force-guided contacts	87
5.6.1	PSR-URM4/5x1/2x2 up to PL e/SIL 3	88
5.6.2	PSR-URM4/4NO/2NC up to PL e/SIL 3	90
5.6.3	PSR-URML4/3x1/1x2/B up to PL e/SIL 3	92
<b>6</b>	<b>Application examples for multifunctional PSRmultifunction safety relays</b>	<b>95</b>
6.1	Multifunctional safety applications with emergency stop, safety doors, and light grids	96
6.1.1	PSR-MXF1/4X1/2X2/B up to PL e/SIL 3	96
6.1.2	PSR-MXF2/4X1/2X2/B up to PL e/SIL 3	99
6.1.3	PSR-MXF3/4X1/2X2/B up to PL e/SIL 3	102
6.1.4	PSR-MXF4/4X1/2X2/B up to PL e/SIL 3	105

**Table of contents**

---

7	Application examples using the modular safety relay system .....	109
7.1	PSR-SDC4/2x1/B master module.....	109
7.1.1	PSR-SDC4/2x1/B up to PL e/SIL 3 .....	110
7.1.2	PSR-SDC4/2x1/B up to PL e/SIL 3 .....	112
7.1.3	PSR-SDC4/2x1/B up to PL e/SIL 3 .....	114
7.2	Contact extension/force-guided contacts .....	117
7.2.1	PSR-URM4/4x1/2x2/B up to PL e/SIL 3 .....	118
8	Diagnostic description .....	121
A	Appendix .....	133
A 1	Explanation of terms .....	133

**Application manual for PSRclassic and PSRmultifunction, and the modular safety relay system**

---

# 1 Introduction

The term “safety” derives from Latin and refers to a state that is free from unacceptable risks. This fundamental human requirement is also enshrined in basic EU law.

The safety of machines and systems mainly depends on the correct application of standards and directives. In Europe, the basis for this is the Machinery Directive, which provides standard specifications to support companies when designing safety-related machines. The aim is to eliminate barriers to trade within the EU. However, even outside the European Economic Area, many European standards are gaining in importance due to their international status.

The fact that the safety of machines and systems not only depends on the components and technologies used, but is mainly affected by the “human” factor is no surprise.

However, the most important aspect is the way in which this fact is dealt with. The main focus should not only be the safety products – with their benefits and their functions – but also easy handling and associated services. The user expects considerably more support in these areas. With the slogan “simplicity in safety”, Phoenix Contact has integrated easy planning, installation, and operation of safety machines or systems and support over their entire lifecycle into its safety concept. Safety does not have to be complicated or involve a great deal of additional effort. Benefit from our expertise and experience as manufacturers of safety-related components by using products with complete application examples and access our qualified service package in all phases of the safety lifecycle.

## 1.1 Target group for this application manual

This manual is aimed at all designers of safety control systems. This manual should provide a simple introduction to the technology of safety-related machines and systems and an overview of safety technology basics. You must always ensure you are familiar with the directives, standards, and regulations relevant to the field of application.

## 1.2 Symbols used

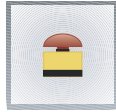

Emergency stop

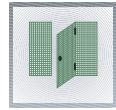

Movable safety equipment

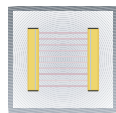

AOPD light grid

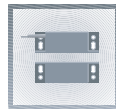

Magnetic switch

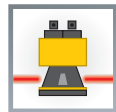

AOPDDR laser scanner

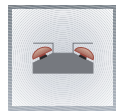

Two-hand control device



Enable switch

## 1.3 Further documentation

For product information and safety technology characteristics of the PSR safety relays from Phoenix Contact, please refer to the relevant product data sheets, the AH EN SAFETY CHARACTERISTICS application note, or the SISTEMA library.

The documentation can be downloaded under the corresponding product at [phoenixcontact.net/products](https://phoenixcontact.net/products).



Observe the product documentation valid for the devices you are using. Make sure you always use the latest documentation.

## 2 Safety of machines and systems

In modern industrial production, the amount of complex technical equipment used is constantly increasing. The purpose of safety technology is to reduce the safety risk to persons, livestock, the environment, and machines as far as possible but at least to a reasonable degree. At the same time, the availability of production equipment should not be restricted any more than is absolutely necessary.

Safety is relative. There can never be a completely safe machine. However, since the opening of the European single market, manufacturers and operators of machines and technical equipment are legally bound to observe European directives for the design and operation of machines and systems.

When adhering to harmonized standards (assumed effect), which apply to a machine or piece of technical equipment, it is assumed that they comply with legal regulations when launched.

The Machinery Directive is one of the most important single market directives. It is of such importance because machine building is one of the industrial mainstays of the European Economic Area. The Machinery Directive defines the requirements machinery must meet before it can be placed on the market and operated in the European Economic Area. It also contains essential health and safety requirements for the planning and construction of machinery and safety components.

Every machine or system poses a risk. According to the requirements of the Machinery Directive, a risk assessment must be carried out for every machine.

If the risk is greater than the level of risk that can be tolerated, risk reduction must be implemented.

Standard EN ISO 12100 "Safety of machinery – General principles for design – Risk assessment and risk reduction" describes the risks to be considered and the general principles for design to reduce risk. It also describes risk assessment and risk reduction as a repetitive process to achieve safety. All phases in the life of the machine are therefore assessed.

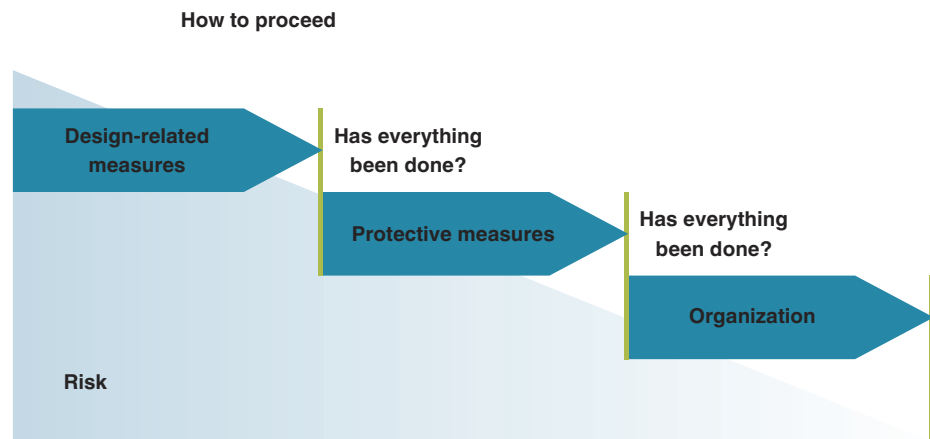

Figure 2-1 Risk reduction in machines

## 2.1 Functional safety

Safety-related parts of machine control systems are frequently assigned to provide safety functions. The contribution to risk reduction of machinery by the safety-related parts of a control system (SRP/CS) is determined in accordance with EN ISO 12100.

In order to achieve the necessary functional safety of a machine or system, it is essential for the safety-related parts of the safety equipment and control devices to operate correctly and, in the event of failure, for the system to remain in the safe state or enter a safe state. The requirements for achieving functional safety are based on the following basic objectives:

- Avoiding systematic errors
- Controlling systematic errors
- Controlling random errors or failures

The requirements of the safety-related parts of a machine control system are specified in EN ISO 13849 (and EN 62061). The standard specifies the various safety levels in the form of the “performance level” (PL) (and “safety integrity level” (SIL)) for the safety-related parts according to the degree of risk and describes the characteristics of the safety functions.

## 2.2 Practical procedure in accordance with EN ISO 13849

In practice, the following steps have proven effective when designing safe control systems in accordance with EN ISO 13849.

### 2.2.1 Definition of the safety function

The safety functions must be defined first. This information is derived from the risk assessment.

Example:

Trigger event:	Opening the safety door.
Response:	The robot drive is set to a safe stop state. The power semiconductor pulses are disabled.
Safe state:	Power circuit has no power.

### 2.2.2 Determination of the required performance level (PL<sub>r</sub>)

The PL<sub>r</sub> is determined in combination with the safety function within the framework of the higher-level risk assessment. For each safety function, the required PL<sub>r</sub> is estimated using the risk graph below.

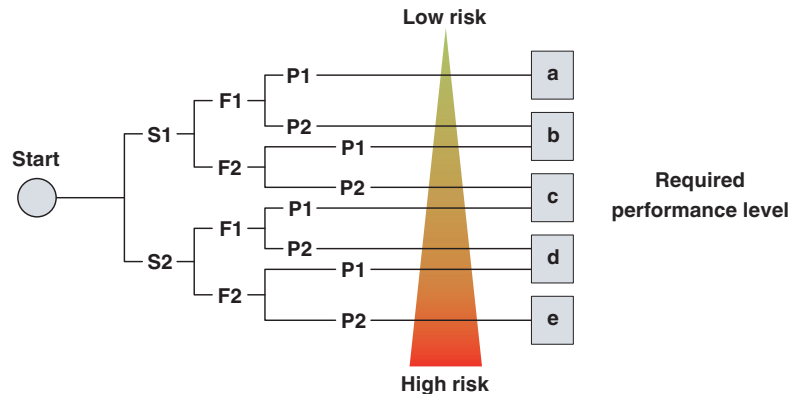

Figure 2-2 Risk graph (in accordance with EN 13849-1)

Meaning of individual parameters:

S: Severity of injury

S1 Slight (normally reversible) injury

S2 Serious (normally irreversible) injury

F: Frequency and duration of exposure to the hazard

F1 Seldom to not very frequent or exposure to hazard is brief

F2 Frequent to continuous or exposure to hazard is long

P: Possibility of avoiding or limiting damage

P1 Possible under specific conditions

P2 Scarcely possible

### 2.2.3 Technical implementation

This step involves the technical pre-planning of the safety function, taking possible technologies and components into account. The safety-related components and parts must then be identified for later verification.

Dividing the safety function into subsystems

In the next step, a safety-related block diagram must be created for further evaluation. As a rule, a safety function consists of sensor - logic - actuator. In the simplest case, each one is a subsystem. These subsystems are connected in series to form the overall safety function.

Application manual for PSRclassic and PSRmultifunction, and the modular safety relay system



Figure 2-3 Safety-related block diagram (in accordance with EN 13849-1)

2.2.4 Determination of the achieved PL for each subsystem

A characteristic value when determining the performance level is the  $PFH_D$  value, the statistical “average frequency of a dangerous failure per hour”. The safety characteristics can be found in the DB EN SAFETY CHARACTERISTICS data sheet or the SISTEMA library.

The diagram below shows the basic relationship between PL and the safety characteristics category, DC, and  $MTTF_D$ .

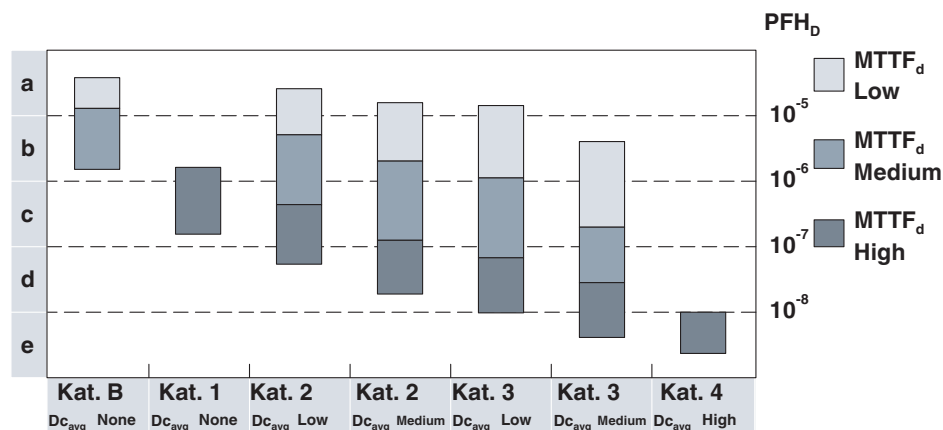

Figure 2-4 Relationship between PL, category, DC, and  $MTTF_D$  (in accordance with EN 13849-1)

The category is an important parameter when determining the PL. The category term has been taken from the previous standard EN 954-1. The requirements for the categories are listed below.

## Safety of machines and systems

Table 2-1 Explanation of categories

Category	Summary of requirements	System behavior	Principle to achieve safety
B	Safety-related parts of control systems and/or their protective equipment, as well as their components, shall be designed, constructed, selected, assembled, and combined in accordance with relevant standards so that they can withstand the expected influences. Basic safety principles must be used.	Occurrence of a fault can lead to the loss of the safety function.	Mainly characterized by the selection of components.
1	The requirements of category B must be met. Proven components and proven safety principles must be used.	Occurrence of a fault can lead to the loss of the safety function but the probability of occurrence is lower than in category B.	Mainly characterized by the selection of components.
2	The requirements of category B and the use of proven safety principles must be met. The safety function must be tested by the machine control system at suitable intervals.	The occurrence of a fault can lead to the loss of the safety function between the tests. The loss of the safety function is detected by the test.	Mainly characterized by the structure.
3	The requirements of category B and the use of proven safety principles must be met. Safety-related parts must be designed so that: <ul style="list-style-type: none"> <li>– A single fault in any of these parts does not lead to the loss of the safety function</li> </ul> and <ul style="list-style-type: none"> <li>– The single fault is detected, whenever this is feasibly possible</li> </ul>	When a single fault occurs, the safety function is always performed. Some faults but not all faults are detected. An accumulation of undetected faults can lead to the loss of the safety function.	Mainly characterized by the structure.
4	The requirements of category B and the use of proven safety principles must be met. Safety-related parts must be designed so that: <ul style="list-style-type: none"> <li>– A single fault in any of these parts does not lead to the loss of the safety function</li> </ul> and <ul style="list-style-type: none"> <li>– The single fault is detected on or before the next demand of the safety function</li> </ul> If detection is not possible, an accumulation of undetected faults must not lead to the loss of the safety function.	When a single fault occurs, the safety function is always performed. The detection of accumulated faults reduces the probability of the loss of the safety function (high DC). The faults are detected in time to prevent a loss of the safety function.	Mainly characterized by the structure.

### **2.2.5 Determination of the achieved PL for the overall safety function**

For subsystems with integrated diagnostic functions such as safety relay modules and safety control systems, the achieved  $PFH_D$  and PL are provided by the manufacturer with the specification of the category.

For subsystems consisting of discrete components (e.g., switches, contactors, valves, etc.), the  $PFH_D$  value is determined from the category, DC, and  $MTTF_D$ . For components that are subject to wear, the  $MTTF_D$  is determined based on the number of operating cycles using the  $B10_D$  value provided by the component manufacturer.

In addition, for category 2 or higher the effect of common cause failure (CCF) must also be considered.

### **2.2.6 Verification of the achieved PL**

Each individual subsystem and the entire safety chain must both meet the requirements of the necessary  $PL_r$ . This includes both the quantitative evaluation and the consideration of systematic aspects, such as proven components and safety principles.

The systematic aspects include:

- Correct dimensioning of components
- Consideration of expected operating conditions and ambient conditions
- Use of basic and proven safety principles
- Avoidance of specification errors and software errors through testing

### **2.2.7 Validation**

The last step should check whether the selected measures achieve the necessary risk reduction and therefore, the protection objectives of the risk assessment. The result of the validation process is included in the final risk assessment.

The purpose of the validation process is to confirm the specification and level of conformity of the design of safety-related parts of the control system (SRP/CS) within the overall specifications for the safety requirements of the machinery. Before validation of the design of the SRP/CS or the combination of SRP/CS that contains the safety function, the specification requirement for the safety function must be confirmed. Validation involves performing analysis and function tests under normal conditions in accordance with the validation plan.

EN ISO 13849-2 contains detailed requirements and describes the basic procedure for the individual validation processes.

## 2.3 Practical procedure in accordance with EN ISO 62061

In practice, the following steps have proven effective when designing safe control systems according to EN 62061.

### 2.3.1 Specification of requirements for the safety-related control function (SRCF)

The safety function must be defined first. This information is derived from the risk assessment.

Example:

- Trigger event:           Opening the safety door.
- Response:                The robot drive is set to a safe stop state. The power semiconductor pulses are disabled.
- Safe state:               Power circuit has no power.

### 2.3.2 Determination of the required safety integrity level (SIL)

The required SIL is determined in combination with the safety function within the framework of the higher-level risk assessment.

Effect	Severe S	Class 3 - 4	Class 5 - 7	Class 8 - 10	Class 11 - 13	Class 14 - 15	
Death, loss of an eye or arm	4	SIL 2	SIL 2	SIL 2	SIL 3	SIL 3	
Permanent, loss of a finger	3	Other measures			SIL 1	SIL 2	SIL 3
Reversible, medical treatment	2				SIL 1	SIL 3	
Reversible, first aid	1					SIL 1	

F Frequency and duration			F Probability of a dangerous event			P Avoidance	
≤ 1 hour	5	+	Frequent	5	+		
> 1 hour to ≤ 1 day	5		Probable	4			
> Day to ≤ 2 weeks	4		Possible	4		Impossible	4
> 2 weeks to ≤ 1 year	3		Rare	3		Possible	3
> 1 year	2		Negligible	2		Probability	2

Figure 2-5 Example of specifying the SIL (in accordance with EN 62061)

### 2.3.3 Drafting the safety-related electrical control system (SRECS)

This step involves the technical pre-planning of the safety function, taking possible technologies and components into account. The safety-related components and parts must then be identified for later verification.

### 2.3.4 Dividing the safety function into subsystems

Following technical implementation and identification of safety-related components, a safety-related block diagram must be created for further evaluation. As a rule, a safety function consists of sensor - logic - actuator. In the simplest case, each one is a subsystem. These subsystems are connected in series to form the overall safety function (see “[Safety-related block diagram \(in accordance with EN 13849-1\)](#)” on page 12).

Determination of the safety integrity for each subsystem

A characteristic value when determining the safety integrity level (SIL) is the PFH<sub>D</sub> value, the statistical “average frequency of a dangerous failure per hour”.

The safety characteristics for Phoenix Contact products can be found in the DB EN SAFETY CHARACTERISTICS data sheet or the SISTEMA library.

Standard EN 62061 describes the subsystem architectures type A to D, which are similar to the categories of EN ISO 13849-1.

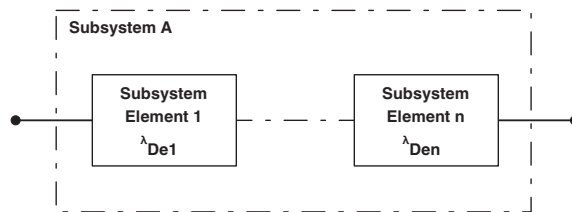

Figure 2-6 Logical representation of subsystem A (in accordance with EN 62061)

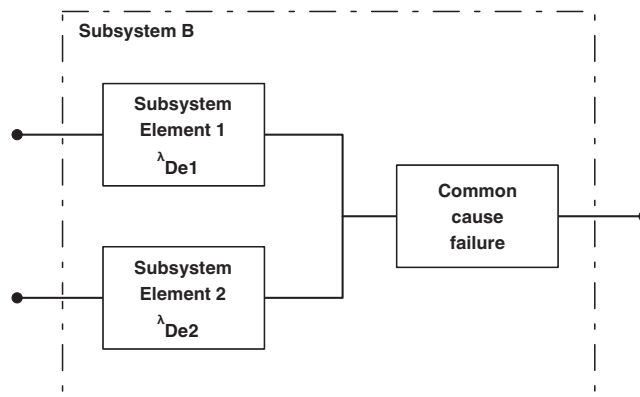

Figure 2-7 Logical representation of subsystem B (in accordance with EN 62061)

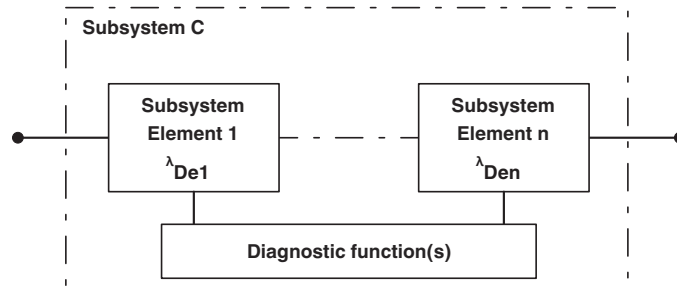

Figure 2-8 Logical representation of subsystem C (in accordance with EN 62061)

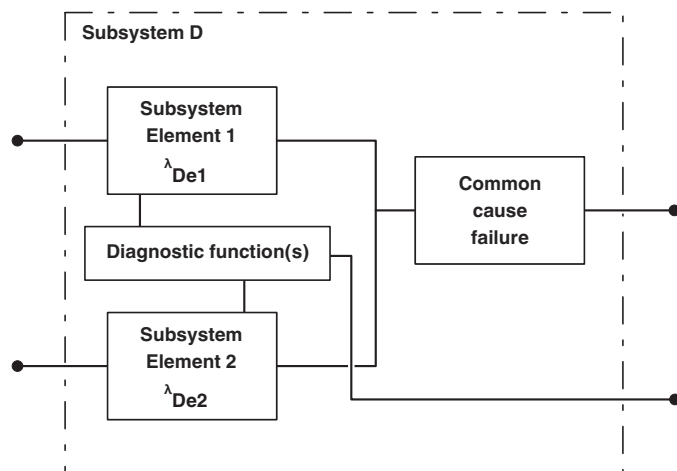

Figure 2-9 Logical representation of subsystem D (in accordance with EN 62061)

For subsystems with integrated diagnostic functions such as safety relay modules and safety control systems, the achieved  $PFH_D$  and SILCL are provided by the manufacturer.

For subsystems consisting of discrete components (e.g., switches, contactors, etc.), the  $PFH_D$  value is calculated according to the subsystem type using a specific equation (see Section 6.7.8.2 of EN 62061). For components that are subject to wear, the failure rate is determined based on the number of operating cycles using the  $B10_D$  value provided by the component manufacturer.

## Application manual for PSRclassic and PSRmultifunction, and the modular safety relay system

### 2.3.5 Determination of the achieved safety integrity for the entire SRECS

To determine the achieved safety integrity level, the  $\text{PFH}_D$  values of the individual subsystems must now be added together. The result must lie within the SIL required for the safety function.

Table 2-2 Determination of the safety integrity level (in accordance with EN 62061)

Safety integrity level	Average frequency of a dangerous failure per hour ( $\text{PFH}_D$ )
3	$\geq 10^{-8}$ to $< 10^{-7}$
2	$\geq 10^{-7}$ to $< 10^{-6}$
1	$\geq 10^{-6}$ to $< 10^{-5}$

Furthermore, the SILCL of an individual subsystem determines the maximum achievable SIL for the SRECS. For safety components with integrated diagnostics, this is provided by the manufacturer. For subsystems consisting of discrete components, this value must be determined using the table below.

Table 2-3 Determination of the safety integrity level for a subsystem with discrete components (in accordance with EN 62061)

Safe failure fraction	Hardware fault tolerance <sup>1)</sup>		
	0	1	2
<60%	Not permitted <sup>2)</sup>	SIL 1	SIL 2
60% to <90%	SIL 1	SIL 2	SIL 3
90% to <99%	SIL 2	SIL 3	SIL 3
$\geq 99\%$	SIL 3	SIL 3	SIL 3

<sup>1)</sup> A hardware fault tolerance of N means that N + 1 faults can lead to a loss of the SRCF.

<sup>2)</sup> See EN 62061, Section 6.7.7.

### 2.3.6 Verification of the achieved SIL

Each individual subsystem and the entire safety chain must both meet the requirements of the necessary SIL. This includes both the quantitative evaluation and the consideration of systematic aspects.

The systematic aspects include:

- Correct dimensioning of components
- Consideration of expected operating conditions and ambient conditions
- Use of basic and proven safety principles
- Avoidance of specification errors and software errors through testing

### 2.3.7 Validation

The last step should check whether the selected measures achieve the necessary risk reduction and therefore, the protection objectives.

The result of the validation process is included in the final risk assessment.

The purpose of the validation process is to confirm the specification and level of conformity of the design of safety-related parts of the control system (SRP/CS) within the overall specifications for the safety requirements of the machinery. Before validation of the design of the SRP/CS or the combination of SRP/CS that contains the safety function, the specification requirement for the safety function must be confirmed. Validation involves performing analysis and function tests under normal conditions in accordance with the validation plan.

EN ISO 13849-2 contains detailed requirements and describes the basic procedure for the individual validation processes.

## Application manual for PSRclassic and PSRmultifunction, and the modular safety relay system

---

## 3 Safety technology basics

### 3.1 Cross-circuit detection

In both category 3 and category 4, a first fault must never lead to the loss of the safety function. This often makes it necessary to provide redundancy in the control structure.

Cross-circuit detection has the ability to detect short circuits, bridges or short circuits to ground between two channels either immediately or within the framework of cyclic self-monitoring.

A cross-circuit may be due to one of the following reasons:

- Squeezing
- High temperatures
- Chips
- Acids
- Etc.

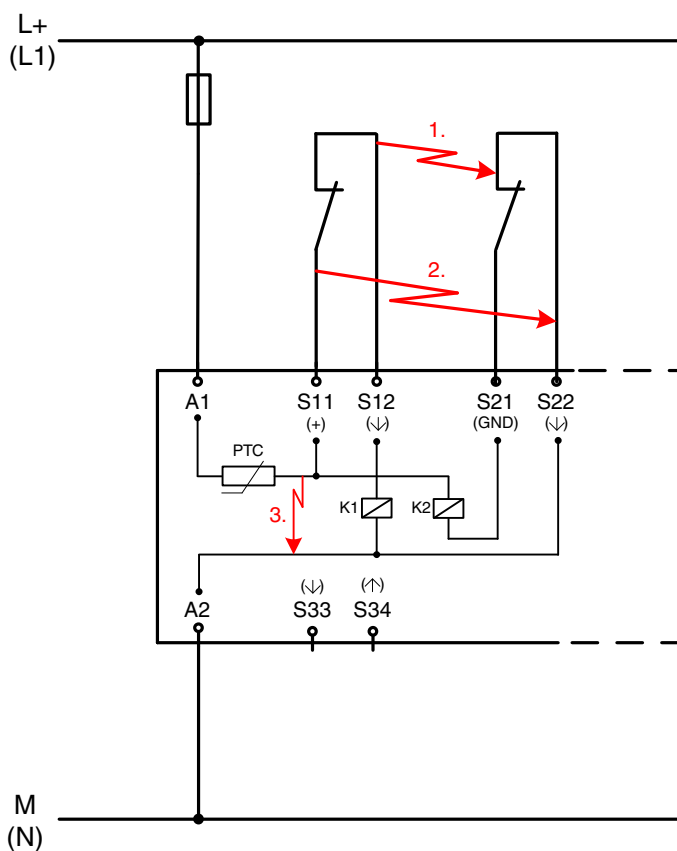

Figure 3-1 Cross-circuit detection

### 3.2 Maximum cable lengths

Depending on the size of the machine or system, a considerable amount of cabling may be required to wire the sensors.



Make sure that the specified cable lengths are not exceeded, so as to ensure error-free operation of the safety relay.

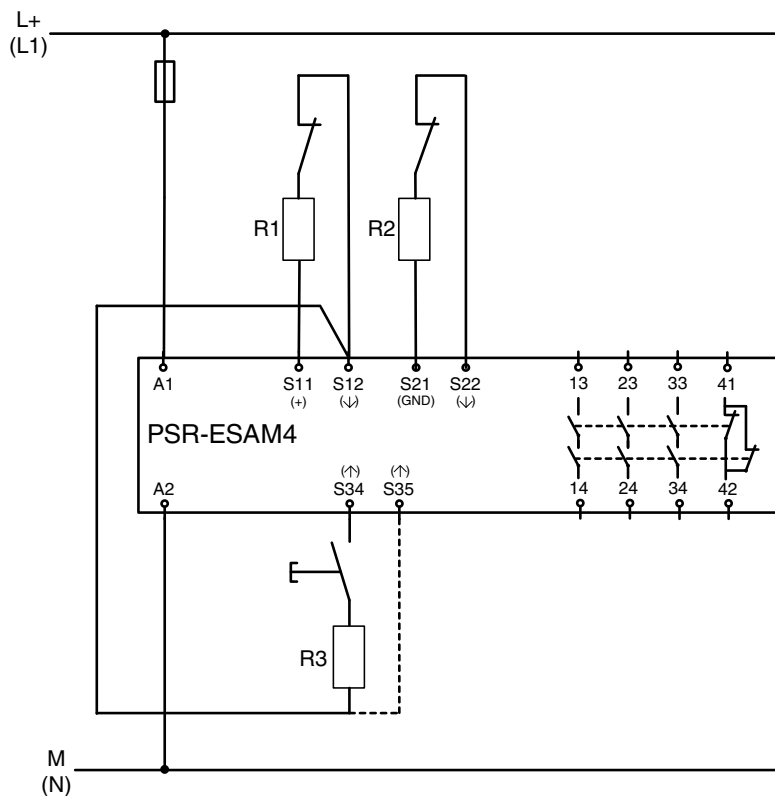

Figure 3-2 Example for calculating the cable lengths

**Example** For an emergency stop application with the PSR-ESAM4 (see [Figure 3-2](#)), the following calculations can be made:

**Assumed values** Cable cross section:  $A = 1.5 \text{ mm}^2$   
Electrical conductivity of copper (Cu):  $\kappa = 56 \text{ m}/(\Omega \times \text{mm}^2)$  (at  $20 \text{ }^\circ\text{C}$ )

**Technical data for the safety relay** Input data:  
Maximum voltage drop for S11-S12, S21-S22, and S33-S34: approximately 2 V DC (corresponds to approximately  $50 \Omega = R_L$ )



The specified values can be found in the data sheet for the corresponding safety relay.

$$R_L = R_1 + R_2 + R_3$$

$$R_L = 50 \Omega$$

**Calculated value**  $l = R_L \times A \times \kappa$   
 $l = 50 \Omega \times 1.5 \text{ mm}^2 \times 56 \text{ m}/(\Omega \times \text{mm}^2)$   
 $l = 4200 \text{ m}$

Where:

$l$	Permissible cable length
$R_L$	Cable resistance
$A$	Cable cross section
$\kappa$ (Kappa)	Electrical conductivity of copper (Cu)

This refers to the forward and return line for both channels in the enable circuit and reset circuit (S11-S12, S21-S22, and S12-S34).



If the application is operated with autostart, the cable lengths between S12-S35 can be disregarded.

### 3.3 Stop

#### Stop categories in accordance with EN 60204-1

Every machine must be fitted with emergency stop equipment.

As per EN 60204-1, this must be implemented in stop category 0 or stop category 1 and must be able to function independently of the operating mode.

In order to stop a machine, three stop categories are defined in EN 60204-1, which describe the stop control sequence independently of an emergency situation.

#### Stop category 0

- Uncontrolled stop by immediately switching off the power supply for the machine drives.

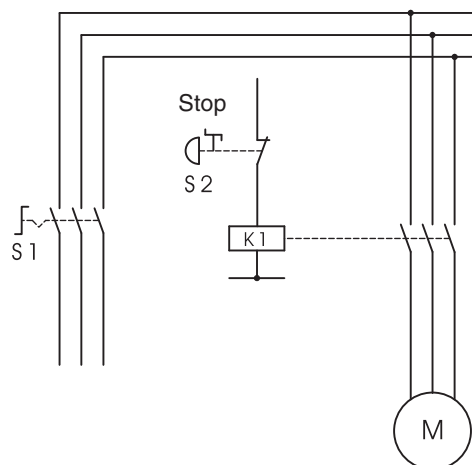

Figure 3-3 Stop category 0 example

#### Stop category 1

- Controlled stop in which the power supply for the machine drives is maintained to obtain the stop state, and the power supply is interrupted only when the function has stopped.

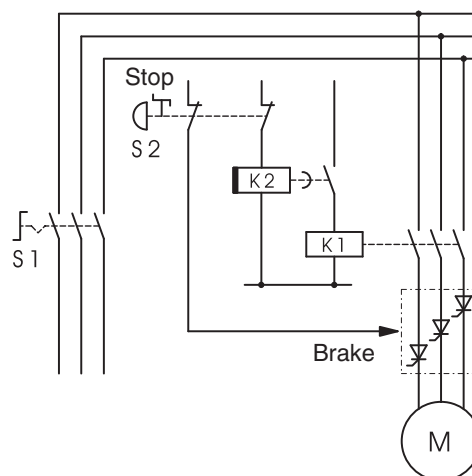

Figure 3-4 Stop category 1 example

**Stop category 2**

- Controlled stop in which the power supply for the machine drives is maintained.

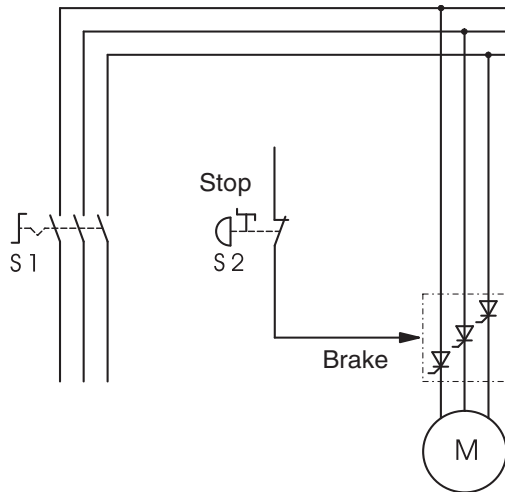

Figure 3-5 Stop category 2 example

### 3.4 Safe isolation

Depending on the version, the PSR safety relays from Phoenix Contact have safe isolation between input and output and between the contacts. Applications with 250 V AC low voltage (typical) can be switched reliably and safely.

#### Insulation between input circuit and enabling current path

Typically, the PSR safety relays provide safe isolation, reinforced insulation, and 6 kV between the input circuit and the enabling current paths.

According to the standards, safe isolation is required if SELV/PELV and low voltage are switched together or led directly next to one another in a device.

Due to the internal structure and the insulation properties between the input and the contacts in Phoenix Contact PSR safety relays, 250 V AC, for example, can be switched without any limitations. The output contacts (13-14, 23-24, ...) are isolated using basic insulation or reinforced insulation, depending on the type.

#### Basic insulation between enabling current paths

Rated surge voltage: 4 kV

A mixture of SELV/PELV and low voltage is strictly prohibited. Only switch 250 V AC at one of the enable contacts if the adjacent contact carries the same potential.

#### Reinforced insulation between the enabling current paths

Rated surge voltage: 6 kV









Reinforced insulation (e.g., thanks to greater air clearances and creepage distances between conductive paths) is designed for one overvoltage category higher than basic insulation. This means that SELV/PELV circuits of  $U \leq 25$  V AC or  $U \leq 60$  V DC and circuits with higher voltages can be mixed.

## 4 Overview of safe switching devices

Phoenix Contact offers a comprehensive range of products for safety functions in machine building.









### 4.1 Conventional safety relays PSRclassic

Table 4-1 Overview of the conventional PSRclassic safety relays

Order No.	Type	Application					Output contacts			Safety approval			Application example, see page ...	Diagnostic description, see page ...
										Cat. EN ISO 13849-1	PL EN ISO 13849-1	SILCL EN 62061		
2963802	PSR-ESA2/4x1/1x2/B	X	X	-	-	-	4	-	1	2	d	3	-	121
2963954														
2963750	PSR-ESA4/2x1/1x2	X	X	-	-	-	2	-	1	4	e	3	58	123
2963938														
2901430	PSR-ESAM2/3x1/1x2/B	X	X	-	-	-	3	-	1	2	d	2	-	121
2901431														
2900525	PSR-ESAM4/2x1/1x2	X	X	-	-	-	2	-	1	4	e	3	36 60 76 80	123
2900526														
2900509	PSR-ESAM4/3x1/1x2/B 24 V AC/DC	X	X	-	-	-	3	-	1	4	e	3	44 64 78	121
2900510														
2901422	PSR-ESAM4/3x1/1x2/B 120 V AC/DC	X	X	-	-	-	3	-	1	4	e	3		
2901425														
2901428	PSR-ESAM4/3x1/1x2/B 230 V AC/DC	X	X	-	-	-	3	-	1	4	e	3		
2901429														
2981114	PSR-ESAM4/3x1/1x2	X	X	-	-	-	3	-	1	4	e	3	62	123
2981127														
2963912	PSR-ESAM4/8x1/1x2	X	X	X	-	-	8	-	1	4	e	3	40 52	121
2963996														
2981059	PSR-ESL4/3x1/1x2/B	X	X	X	-	-	3	-	1	4	e	3	32 38 48 72	121
2981062														
2981800	PSR-ESD/4x1/30	X	X	X	-	-	2	2	0	4	e	3	34 42 50 54 66 68	125
2981813														
2981428	PSR-ESD/5x1/1x2/300	X	X	X	-	-	3	2 <sup>1)</sup>	1	4	e	3	70	124
2981431														

## Application manual for PSRclassic and PSRmultifunction, and the modular safety relay system









Table 4-1 Overview of the conventional PSRclassic safety relays

Order No.	Type	Application					Output contacts			Safety approval			Application example, see page ...	Diagnostic description, see page ...
										Cat. EN ISO 13849-1	PL EN ISO 13849-1	SILCL EN 62061		
2963721	PSR-THC4/2x1/1x2	-	X	-	-	X	2	-	1	4	e	3	84	121
2963983														
2963734	PSR-URM4/5x1/2x2	Contact extension					5	-	2	4	e	3	88	126
2964005														
2981033	PSR-URM4/5x1/2x2/B	Contact extension					5	-	2	4	e	3	-	127
2981046														
2702924	PSR-URM4/4NO/2NC 42 - 230 V AC/DC	Contact extension					4	-	1	4	e	3	90	127
2702925														
2903583	PSR-URML4/3x1/1x2/B	Contact extension					3	-	1	4	e	3	92	128
2903584														

<sup>1)</sup> Delayed contacts only for category 3

## 4.2 Multifunctional safety relays PSRmultifunction

Table 4-2 Overview of the multifunctional PSRmultifunction safety relays









Order No.	Type	Application					Output contacts			Safety approval			Application example, see page ...	Diagnostic description, see page ...
										Cat. EN ISO 13849-1	PL EN ISO 13849-1	SILCL EN 62061		
2902725	PSR-MXF1/4x1/2x2/B <sup>2)</sup>	X	X	-	X	-	4	-	2	4	e	3	96	See data sheet in the product download area
2902726		X	X	-	X	-	4	-	2	4	e	3	99	
2903253		X	X	-	X	-	4	-	2	4	e	3	102	
2903254	PSR-MXF2/4x1/2x2/B <sup>2)</sup>	X	X	X	X	-	4	-	2	4	e	3	105	
2903255		X	X	X	X	-	4	-	2	4	e	3	105	
2903256		X	X	X	X	-	4	-	2	4	e	3	105	
2903257	PSR-MXF3/4x1/2x2/B <sup>2)</sup>	X	X	X	X	-	4	-	2	4	e	3	105	
2903258		X	X	X	X	-	4	-	2	4	e	3	105	
2903259		X	X	X	X	-	4	-	2	4	e	3	105	
2903260	PSR-MXF4/4x1/2x2/B <sup>2)</sup>	X	X	X	X	-	4	-	2	4	e	3	105	
2903261		X	X	X	X	-	4	-	2	4	e	3	105	
2903262		X	X	X	X	-	4	-	2	4	e	3	105	

<sup>2)</sup> Multifunctional safety relays - up to three safety functions in one device

## Application manual for PSRclassic and PSRmultifunction, and the modular safety relay system

### 4.3 Modular safety relay system

Table 4-3 Overview of the modular safety relay system

Order No.	Type	Application					Output contacts			Safety approval			Application example, see page ...	Diagnostic description, see page ...
										Cat. EN ISO 13849-1	PL EN ISO 13849-1	SILCL EN 62061		
2981486	PSR-SDC4/2x1/B	X	X	X	X	-	2	-	1 <sup>3)</sup>	4	e	3	110	129
2981499													112 114	
2981677	PSR-URM4/4x1/2x2/B	Contact extension					4	-	2	4	e	3	118	130
2981680														
2981732	PSR-URD3/4x1/2x2/3	Contact extension					-	4	2 <sup>4)</sup>	3	d	2	-	131
2981745														
2981512	PSR-URD3/4x1/2x2/30	Contact extension					-	4	2 <sup>4)</sup>	3	d	2	-	131
2981525														

<sup>3)</sup> Non-isolated

<sup>4)</sup> Delayed

## 5 Application examples for conventional PSRclassic safety relays

### 5.1 Emergency stop

**Emergency stop in accordance with EN ISO 13850, EN 60204-1**

Emergency stop refers to an emergency operation that is intended to stop a dangerous process or movement.

The emergency stop function is triggered by a single operator operation. This function must be available and operational at all times in accordance with EN ISO 13850. In this case, the operating mode is not taken into consideration.

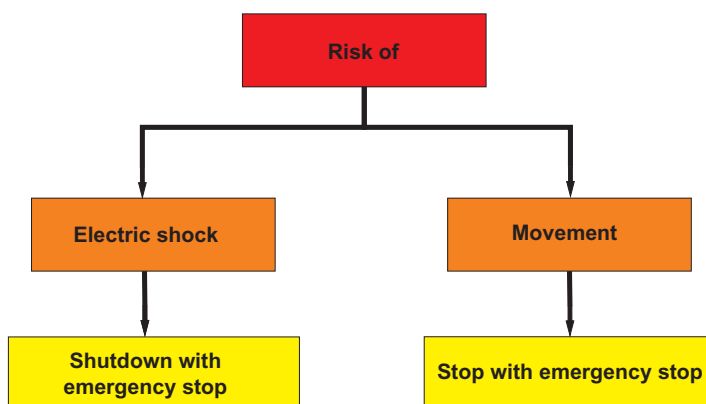
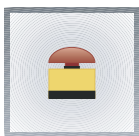

Figure 5-1 Emergency switching off and emergency stop

The emergency stop function should not be used as a substitute for protective measures or other safety functions, but should be designed as a complementary protective measure. The emergency stop function must not adversely affect the effectiveness of safety equipment or equipment with other safety functions.

Furthermore, it must be designed so that when faced with the decision to activate the emergency stop control actuator, the operator does not have to consider the resulting effects.

Application manual for PSRclassic and PSRmultifunction, and the modular safety relay system



### 5.1.1 PSR-ESL4/3x1/1x2/B up to PL c/SIL 1

#### Single-channel emergency stop monitoring with manual reset

<b>Order No.</b>	2981059 with screw connection 2981062 with spring-cage connection
<b>Technical data</b>	<ul style="list-style-type: none"> <li>- 24 V AC/DC</li> <li>- 3 enabling current paths, 1 signaling current path</li> <li>- Monitored manual start or autostart</li> <li>- Basic insulation</li> <li>- Stop category 0</li> <li>- Cat. 4/PLe in accordance with EN ISO 13849-1, SILCL 3 in accordance with EN 62061</li> </ul>

#### Application example

- Single-channel emergency stop monitoring
- Manual reset (S33, S34)
- Stop category 0
- Safety level of the example up to PL c (EN ISO 13849-1) and SIL 1 (EN 62061)

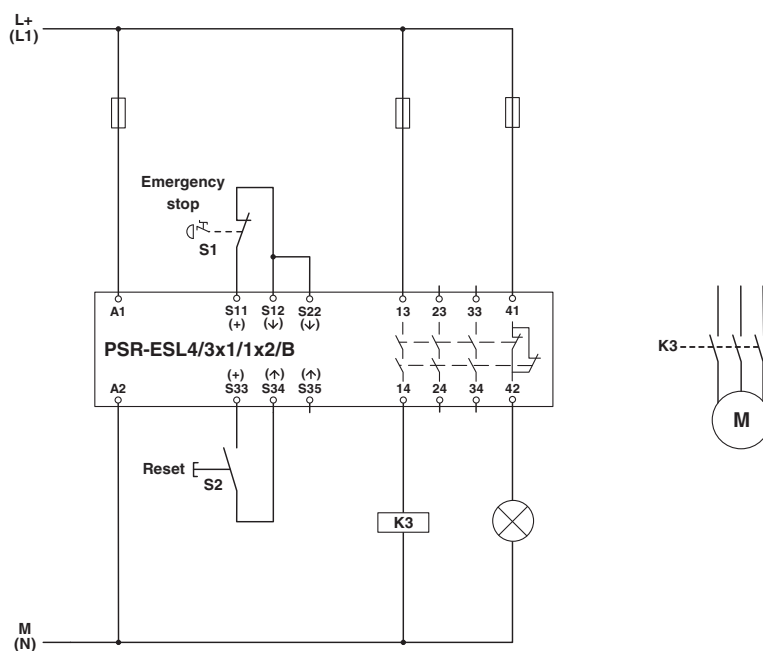
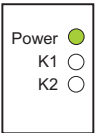

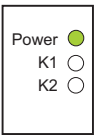

Figure 5-2 Single-channel emergency stop monitoring with manual reset PSR-ESL4/3x1/1x2/B

## Application examples for conventional PSRclassic safety relays

### Function description

Start	Action	Result	Diagnostics
	1. Unlock emergency stop button S1.	The emergency stop button closes enable circuit S11 and S12 of the safety relay.  The circuit is enabled via the reset button.	
	2. Press reset button S2.	Contactors K3 is activated.	
Stop	Action	Result	Diagnostics
	1. Press emergency stop button S1.	The safety function is triggered and contactor K3 drops out.	

For additional diagnostic descriptions, please refer to Section 8.

### Notes on the application example

1. The emergency stop control device is positive opening in accordance with EN 60947-5-1.
2. Stop category 0 describes an immediate stop by removal of power by interrupting a machine or drive element in accordance with EN 60204-1.
3. Proven components and proven safety principles in accordance with EN ISO 13849-2 must be used when applying category 1.
4. Occurrence of a fault can lead to the loss of the safety function.
5. The connecting cables for the emergency stop control device should either be laid separately or protected against mechanical damage.
6. When using the safety relay, take into consideration the maximum permissible number of cycles for observing the SIL/PL safety characteristics in the specific application. The safety characteristics can be found in the AH EN SAFETY CHARACTERISTICS application note or the SISTEMA library.

Application manual for PSRclassic and PSRmultifunction, and the modular safety relay system

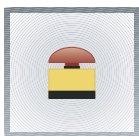

### 5.1.2 PSR-ESD/4x1/30 up to PL c/SIL 1

#### Single-channel emergency stop monitoring with manual reset

<b>Order No.</b>	2981800 with screw connection 2981813 with spring-cage connection
<b>Technical data</b>	<ul style="list-style-type: none"> <li>- 24 V DC</li> <li>- 2 undelayed enabling current paths, 2 delayed enabling current paths</li> <li>- Adjustable delay time (0 s ... 30 s)</li> <li>- Monitored manual start or autostart</li> <li>- Basic insulation</li> <li>- Cat. 4/PLe in accordance with EN ISO 13849-1, SILCL 3 in accordance with EN 62061</li> </ul>

#### Application example

- Single-channel emergency stop monitoring
- Manual reset (A1, S34)
- Stop category 0
- Safety level of the example up to PL c (EN ISO 13849-1) and SIL 1 (EN 62061)

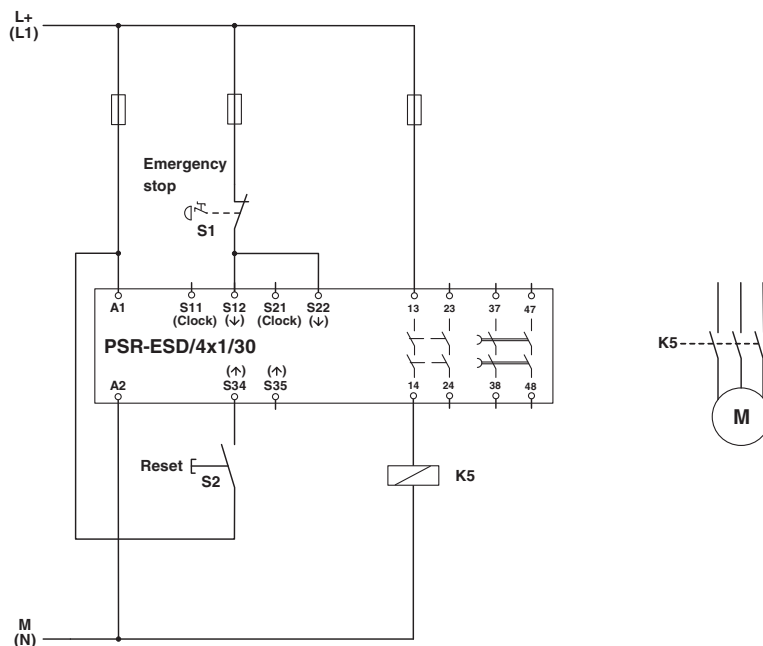
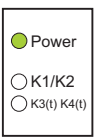





Figure 5-3 Single-channel emergency stop monitoring with manual reset PSR-ESD/4x1/30

Application examples for conventional PSRclassic safety relays

Function description

Start	Action	Result	Diagnostics
	1. Unlock emergency stop button S1.	The emergency stop button closes enable circuit S12 and S22 of the safety relay.  The circuit is enabled via the reset button.	
	2. Press reset button S2.	Contactors K5 is activated.	
Stop	Action	Result	Diagnostics
	1. Press emergency stop button S1.	The safety function is triggered and contactor K5 drops out immediately.	
		After the preset time, the dropout delayed enable contacts of the safety relay drop out.	

For additional diagnostic descriptions, please refer to Section 8.

Notes on the application example

1. The emergency stop control device is positive opening in accordance with EN 60947-5-1.
2. Stop category 0 describes an immediate stop by removal of power by interrupting a machine or drive element in accordance with EN 60204-1.
3. Proven components and proven safety principles in accordance with EN ISO 13849-2 must be used when applying category 1.
4. Occurrence of a fault can lead to the loss of the safety function.
5. The connecting cables for the emergency stop control device should either be laid separately or protected against mechanical damage.
6. When using the safety relay, take into consideration the maximum permissible number of cycles for observing the SIL/PL safety characteristics in the specific application. The safety characteristics can be found in the AH EN SAFETY CHARACTERISTICS application note or the SISTEMA library.

Application manual for PSRclassic and PSRmultifunction, and the modular safety relay system

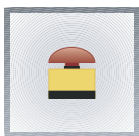

### 5.1.3 PSR-ESAM4/2x1/1x2 up to PL e/SIL 3

Two-channel emergency stop monitoring with manual reset (with cross-circuit detection)

<b>Order No.</b>	2900525 with screw connection 2900526 with spring-cage connection
<b>Technical data</b>	<ul style="list-style-type: none"> <li>- 24 V AC/DC</li> <li>- 2 enabling current paths, 1 signaling current path</li> <li>- Monitored manual start or autostart</li> <li>- Reinforced insulation</li> <li>- Cat. 4/PL e in accordance with EN ISO 13849-1, SILCL 3 in accordance with EN 62061</li> </ul>

**Application example**



- Two-channel emergency stop monitoring
- Cross-circuit detection
- Ground fault detection (S11, S12)
- Manual reset (S12, S34)
- Feedback of contactor contacts K3 ... K6 at S34
- Stop category 0
- Monitoring of external contactors
- Safety level of the example up to PL e (EN ISO 13849-1) and SIL 3 (EN 62061)

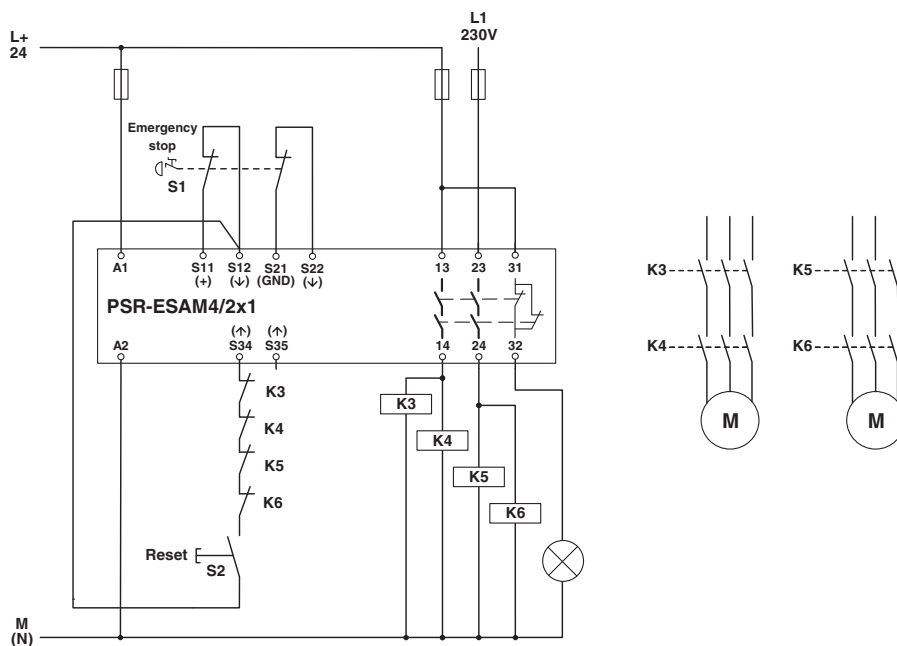

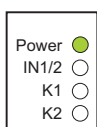

Figure 5-4 Two-channel emergency stop monitoring with manual reset PSR-ESAM4/2x1/1x2

## Application examples for conventional PSRclassic safety relays

### Function description

Start	Action	Result	Diagnostics
	1. Unlock emergency stop button S1.	The emergency stop button closes enable circuit S11, S12 and S21, S22 of the safety relay.  The circuit is enabled via the reset button.	
	2. Press reset button S2.	Contactors K3 ... K6 are activated and the mirror contacts (N/C contacts of K3 ... K6) in the reset circuit are opened.	
Stop	Action	Result	Diagnostics
	1. Press emergency stop button S1.	The safety function is triggered and contactors K3 ... K6 drop out. In the reset circuit, the mirror contacts of K3 ... K6 are closed.	

For additional diagnostic descriptions, please refer to Section 8.

### Notes on the application example

1. The emergency stop control device is positive opening in accordance with EN 60947-5-1.
2. Contactors K3, K4, K5, and K6 have mirror contacts in accordance with EN 60947-4-1.
3. Stop category 0 describes an immediate stop by removal of power by interrupting a machine or drive element in accordance with EN 60204-1.
4. Install the safety relay and contactors together in an installation space in accordance with EN 60204-1 (e.g., in the control cabinet). This prevents a cross-circuit at the output of the safety relay.
5. When using the safety relay, take into consideration the maximum permissible number of cycles for observing the SIL/PL safety characteristics in the specific application. The safety characteristics can be found in the AH EN SAFETY CHARACTERISTICS application note or the SISTEMA library.

Application manual for PSRclassic and PSRmultifunction, and the modular safety relay system

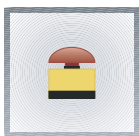

5.1.4 PSR-ESL4/3x1/1x2/B up to PL d/SIL 2

Two-channel emergency stop monitoring with manual reset

<b>Order No.</b>	2981059 with screw connection 2981062 with spring-cage connection
<b>Technical data</b>	<ul style="list-style-type: none"> <li>- 24 V AC/DC</li> <li>- 3 enabling current paths, 1 signaling current path</li> <li>- Monitored manual start or autostart</li> <li>- Basic insulation</li> <li>- Cat. 4/PLe in accordance with EN ISO 13849-1, SILCL 3 in accordance with EN 62061</li> </ul>

Application example



- Two-channel emergency stop monitoring
- Manual reset (S33, S34)
- Feedback of contactor contacts K3 and K4 at S33 and S34
- Stop category 0
- Monitoring of external contactors
- Safety level of the example up to PL d (EN ISO 13849-1) and SIL 2 (EN 62061)

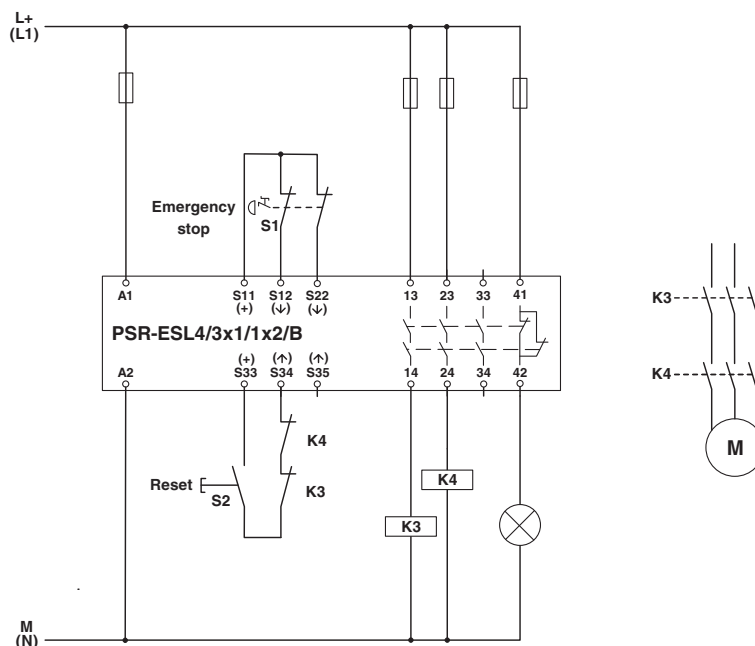
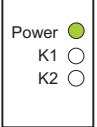
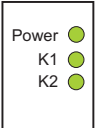
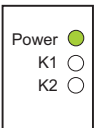

Figure 5-5 Two-channel emergency stop monitoring with manual reset PSR-ESL4/3x1/1x2/B

## Application examples for conventional PSRclassic safety relays

### Function description

Start	Action	Result	Diagnostics
	1. Unlock emergency stop button S1.	The emergency stop button closes enable circuit S11, S12, and S22 of the safety relay.  The circuit is enabled via the reset button.	
	2. Press reset button S2.	Contactors K3 and K4 are activated and the mirror contacts (N/C contacts of K3 and K4) in the reset circuit are opened.	
Stop	Action	Result	Diagnostics
	1. Press emergency stop button S1.	The safety function is triggered and contactors K3 and K4 drop out. In the reset circuit, the mirror contacts of K3 and K4 are closed.	

For additional diagnostic descriptions, please refer to Section 8.

### Notes on the application example

1. The emergency stop control device is positive opening in accordance with EN 60947-5-1.
2. Contactors K3 and K4 have mirror contacts in accordance with EN 60947-4-1.
3. Stop category 0 describes an immediate stop by removal of power by interrupting a machine or drive element in accordance with EN 60204-1.
4. When using the safety relay, take into consideration the maximum permissible number of cycles for observing the SIL/PL safety characteristics in the specific application. The safety characteristics can be found in the AH EN SAFETY CHARACTERISTICS application note or the SISTEMA library.

Application manual for PSRclassic and PSRmultifunction, and the modular safety relay system

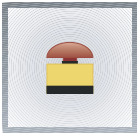

5.1.5 PSR-ESAM4/8x1/1x2 up to PL e/SIL 3

Two-channel emergency stop monitoring with manual reset (with cross-circuit detection)

<b>Order No.</b>	2963912 with screw connection 2963996 with spring-cage connection
<b>Technical data</b>	<ul style="list-style-type: none"> <li>- 24 V AC/DC</li> <li>- 8 enabling current paths, 1 signaling current path</li> <li>- Monitored manual start or autostart</li> <li>- Reinforced insulation/basic insulation</li> <li>- Cat. 4/PLe in accordance with EN ISO 13849-1, SILCL 3 in accordance with EN 62061</li> </ul>

Application example



- Two-channel emergency stop monitoring
- Cross-circuit detection
- Ground fault detection
- Manual reset (S33, S34)
- Feedback of contactor contacts K3, K4, K8, K9, K10, K11 at S33 and S34
- Stop category 0
- Monitoring of external contactors
- Safety level of the example up to PL e (EN ISO 13849-1) and SIL 3 (EN 62061)

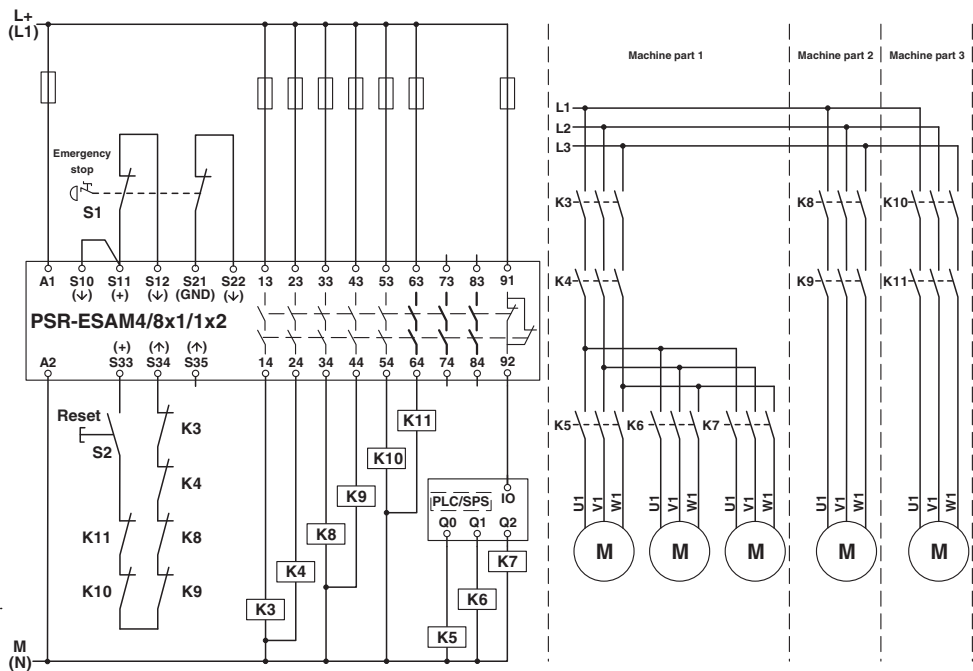





Figure 5-6 Two-channel emergency stop monitoring with manual reset PSR-ESAM4/8x1/1x2

## Application examples for conventional PSRclassic safety relays

### Function description

Start	Action	Result	Diagnostics
	1. Unlock emergency stop button S1.	The emergency stop button closes enable circuit S11, S12 and S21, S22 of the safety relay.  The circuit is enabled via the reset button.	
	2. Press reset button S2.	Contactors K3, K4, K8, K9, K10, and K11 are activated and the mirror contacts (N/C contacts of K3, K4, K8, K9, K10, K11) in the reset circuit are opened. Once signal contacts 41 and 42 of the safety relay have been opened, the PLC activates contactors K5, K6, and K7 depending on the user program. All three machine parts are activated.	
Stop	Action	Result	Diagnostics
	1. Press emergency stop button S1.	The safety function is triggered and machine parts 1–3 are deactivated. In the reset circuit, the mirror contacts of K3, K4, K8, K9, K10, and K11 are closed.	

For additional diagnostic descriptions, please refer to Section 8.

### Notes on the application example

1. The emergency stop control device is positive opening in accordance with EN 60947-5-1.
2. Contactors K3, K4, K8, K9, K10, and K11 have mirror contacts in accordance with EN 60947-4-1.
3. Stop category 0 describes an immediate stop by removal of power by interrupting a machine or drive element in accordance with EN 60204-1.
4. When using the safety relay, take into consideration the maximum permissible number of cycles for observing the SIL/PL safety characteristics in the specific application. The safety characteristics can be found in the AH EN SAFETY CHARACTERISTICS application note or the SISTEMA library.

Application manual for PSRclassic and PSRmultifunction, and the modular safety relay system

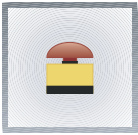

5.1.6 PSR-ESD/4x1/30 up to PL e/SIL 3

Two-channel emergency stop monitoring with dropout delayed contacts (with cross-circuit detection)

<b>Order No.</b>	2981800 with screw connection 2981813 with spring-cage connection
<b>Technical data</b>	<ul style="list-style-type: none"> <li>- 24 V DC</li> <li>- 2 undelayed enabling current paths, 2 delayed enabling current paths</li> <li>- Adjustable delay time (0 s ... 30 s)</li> <li>- Monitored manual start or autostart</li> <li>- Basic insulation</li> <li>- Cat. 4/PLe in accordance with EN ISO 13849-1, SILCL 3 in accordance with EN 62061</li> </ul>

Application example



- Two-channel emergency stop monitoring with controlled stop
- Cross-circuit detection
- Ground fault detection
- Manual reset (A1, S34)
- Feedback of contactor contacts K5 ... K7 at S34
- Stop category 1
- Monitoring of external contactors
- Safety level of the example up to PL e (EN ISO 13849-1) and SIL 3 (EN 62061)

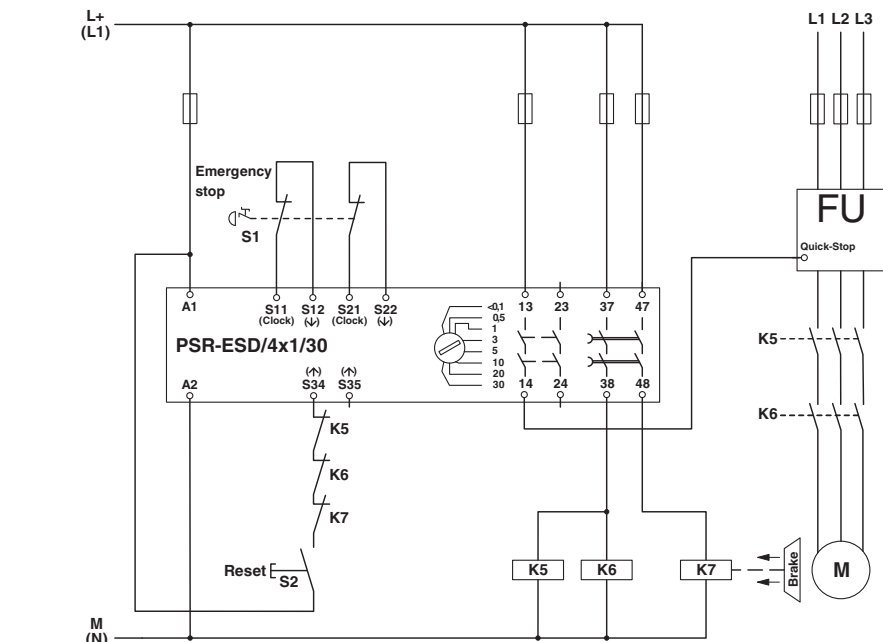

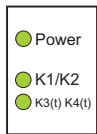

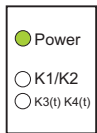

Figure 5-7 Two-channel emergency stop monitoring with dropout delayed contacts PSR-ESD/4x1/30

## Application examples for conventional PSRclassic safety relays

## Function description

Start	Action	Result	Diagnostics
	1. Unlock emergency stop button S1.	The emergency stop button closes enable circuit S11, S12 and S21, S22 of the safety relay.  The circuit is enabled via the reset button.	
	2. Press reset button S2.	Contactors K5 ... K7 are activated and the mirror contacts (N/C contacts of K5 ... K7) in the reset circuit are opened.	
Stop	Action	Result	Diagnostics
	1. Press emergency stop button S1.	The safety function is triggered and contacts 13, 14 of the safety relay open immediately, which initiates an automatic "quick stop" at the FI.	
		After the preset time, the dropout delayed contacts 37, 38 and 47, 48 deactivate the three contactors K5 ... K7 with a time delay. After the delayed deactivation, the mains supply to the motor is disconnected from the FI and at the same time brake unlocking is switched off so that the brake blocks the drive. In the reset circuit, the mirror contacts of K5 ... K7 are closed.	

For additional diagnostic descriptions, please refer to Section 8.

## Notes on the application example

1. The emergency stop control device is positive opening in accordance with EN 60947-5-1.
2. Contactors K5, K6, and K7 have mirror contacts in accordance with EN 60947-4-1.
3. Stop category 1 describes a controlled stop with power available in accordance with EN 60204-1. This means that the power is only switched off after the connected machine has stopped.
4. The brake is not part of the safety function.
5. Install the safety relay, FI, and contactors together in an installation space in accordance with EN 60204-1 (e.g., in the control cabinet). This prevents a cross-circuit at the output of the safety relay.
6. When using the safety relay, take into consideration the maximum permissible number of cycles for observing the SIL/PL safety characteristics in the specific application. The safety characteristics can be found in the AH EN SAFETY CHARACTERISTICS application note or the SISTEMA library.
7. Make sure that the frequency converter and the safety relay have the same ground potential.

Application manual for PSRclassic and PSRmultifunction, and the modular safety relay system



### 5.1.7 PSR-ESAM4/3x1/1x2/B up to PL e/SIL 3

Two-channel cable-operated switch monitoring with manual reset (with cross-circuit detection)

<b>Order No.</b>	2900509 with screw connection 2900510 with spring-cage connection
<b>Technical data</b>	<ul style="list-style-type: none"> <li>- 24 V AC/DC</li> <li>- 3 enabling current paths, 1 signaling current path</li> <li>- Monitored manual start or autostart</li> <li>- Basic insulation</li> <li>- Cat. 4/PLe in accordance with EN ISO 13849-1, SILCL 3 in accordance with EN 62061</li> </ul>

**Application example**



- Two-channel cable-operated switch monitoring
- Cross-circuit detection
- Ground fault detection
- Manual reset (S12, S34)
- Feedback of contactor contacts K3 and K4 at S34
- Stop category 0
- Monitoring of external contactors
- Safety level of the example up to PL e (EN ISO 13849-1) and SIL 3 (EN 62061)

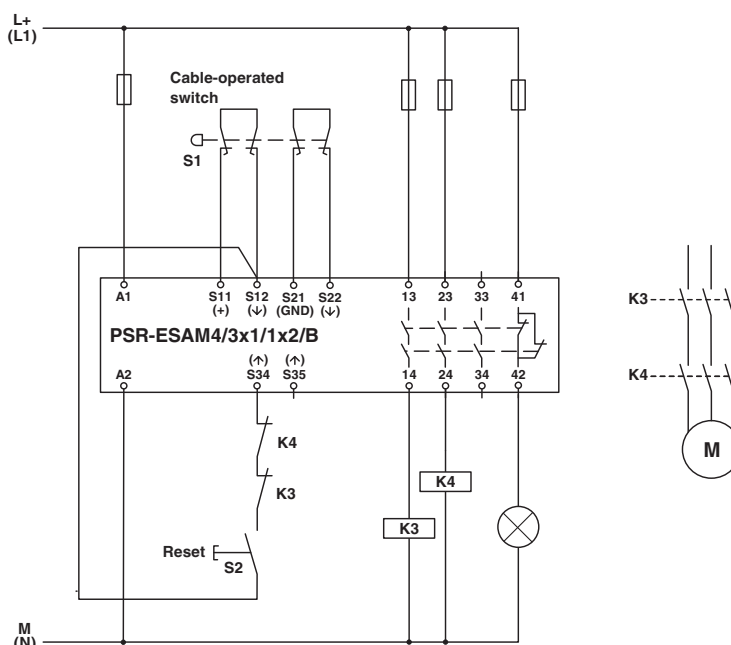
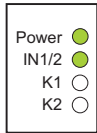
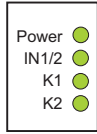
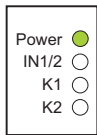

Figure 5-8 Two-channel cable-operated switch monitoring with manual reset PSR-ESAM4/3x1/1x2/B

## Application examples for conventional PSRclassic safety relays

### Function description

Start	Action	Result	Diagnostics
	1. Cable-operated switch S1 is not activated.	The cable-operated switch closes enable circuit S11, S12 and S21, S22 of the safety relay.  The circuit is enabled via the reset button.	
	2. Press reset button S2.	Contactors K3 and K4 are activated and the mirror contacts (N/C contacts of K3 and K4) in the reset circuit are opened.	
Stop	Action	Result	Diagnostics
	1. Pull cable-operated switch S1.	The safety function is triggered and contactors K3 and K4 drop out.  In the reset circuit, the mirror contacts of K3 and K4 are closed.	

For additional diagnostic descriptions, please refer to Section 8.

### Notes on the application example

1. The cable-operated switch is positive opening in accordance with EN 60947-5-1.
2. Contactors K3 and K4 have mirror contacts in accordance with EN 60947-4-1.
3. Stop category 0 describes an immediate stop by removal of power by interrupting a machine or drive element in accordance with EN 60204-1.
4. When using the safety relay, take into consideration the maximum permissible number of cycles for observing the SIL/PL safety characteristics in the specific application. The safety characteristics can be found in the AH EN SAFETY CHARACTERISTICS application note or the SISTEMA library.

## Application manual for PSRclassic and PSRmultifunction, and the modular safety relay system

---

## 5.2 Light grids (ESPE)/laser scanners (AOPD)

### Light grids

Light grids consist of a transmit and receive unit and have a two-dimensional monitoring range. Light grids are electro-sensitive protective equipment used to protect operating personnel working on or in the vicinity of dangerous machines. The advantage over mechanical systems is their non-contact and therefore maintenance-free function.

Observe the following when using light grids:

- The light grids must be mounted so that it is not possible to reach over, reach under, and step behind the protective field. If this cannot be ensured, additional safety equipment must be installed.
- The machine control system must be capable of being influenced electrically and permit dangerous states to be exited immediately in each operating phase.
- The ambient conditions must not adversely affect the effectiveness of the light protective system.
- Electro-sensitive protective equipment does not provide protection from flying parts.

### Relevant standards

EN 61496-1, EN 61496-2: Requirements for electro-sensitive protective equipment

EN ISO 13855: Positioning of safeguards with respect to the approach speeds of parts of the human body

### Laser scanners

Laser scanners scan the shape of the environment like a type of optical radar. The distance to an object is determined by a runtime measurement. A mirror integrated in the devices is used to achieve two-dimensional scanning. The protective fields that are used for shutdown in the event of a hazardous situation can be defined using software. As the distance increases, the resolution of the scanner decreases and this therefore affects the required minimum distance.

### Examples of use

- Protection of the danger zone for presses
- Protection of the danger zone for production cells
- Back step protection for insert areas of robot cells

Application manual for PSRclassic and PSRmultifunction, and the modular safety relay system

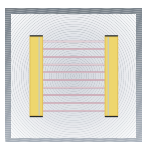

### 5.2.1 PSR-ESL4/3x1/1x2/B up to PL e/SIL 3

#### Two-channel light grid monitoring with manual reset (ESPE type 4)

<b>Order No.</b>	2981059 with screw connection 2981062 with spring-cage connection
<b>Technical data</b>	<ul style="list-style-type: none"> <li>- 24 V AC/DC</li> <li>- 3 enabling current paths, 1 signaling current path</li> <li>- Monitored manual start or autostart</li> <li>- Basic insulation</li> <li>- Cat. 4/PLe in accordance with EN ISO 13849-1, SILCL 3 in accordance with EN 62061</li> </ul>

#### Application example



- Two-channel light grid monitoring
- Cross-circuit detection via the light grid
- Manual reset (S33, S34)
- Feedback of contactor contacts K3 and K4 at S34
- Stop category 0
- Monitoring of external contactors
- Safety level of the example up to PL e (EN ISO 13849-1) and SIL 3 (EN 62061)

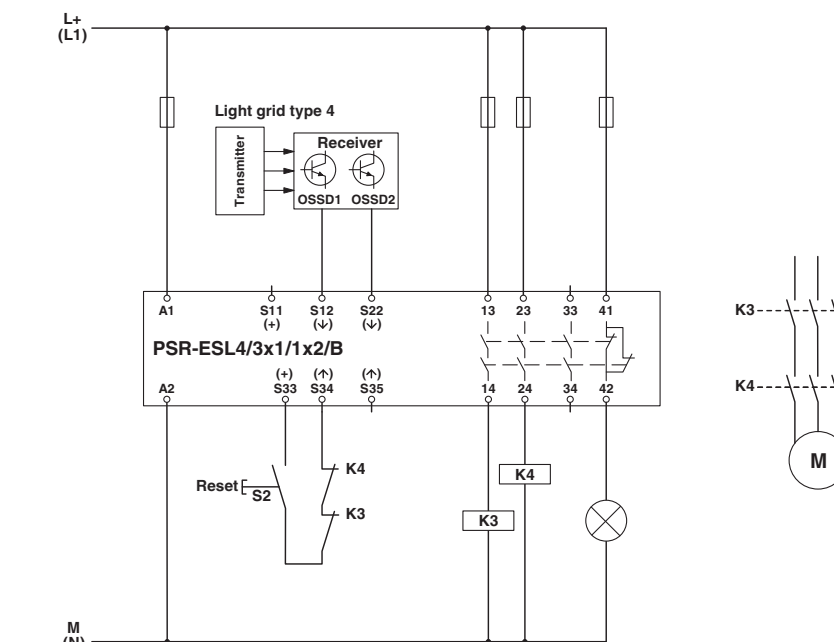
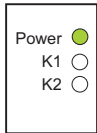



Figure 5-9 Two-channel light grid monitoring with manual reset PSR-ESL4/3x1/1x2/B

## Application examples for conventional PSRclassic safety relays

### Function description

Start	Action	Result	Diagnostics
	1. The light grid is active, there is no object in the protective field.	Both OSSD signals from the light grid provide HIGH signals to enable circuit S12 and S22 of the safety relay.  The circuit is enabled via the reset button.	
	2. Press reset button S2.	Contactors K3 and K4 are activated and the mirror contacts (N/C contacts of K3 and K4) in the reset circuit are opened.	
Stop	Action	Result	Diagnostics
	1. The light grid is interrupted, there is an object in the protective field.	The safety function is triggered by the interruption of the light grid and contactors K3 and K4 drop out.  In the reset circuit, the mirror contacts of K3 and K4 are closed.	

For additional diagnostic descriptions, please refer to Section 8.

### Notes on the application example

1. The light grid (ESPE) must meet type 4 requirements of standard EN 61496-1.
2. Make sure that the signal generator (e.g., light grid) and the safety relay have the same ground potential.
3. Contactors K3 and K4 have mirror contacts in accordance with EN 60947-4-1.
4. Stop category 0 describes an immediate stop by removal of power by interrupting a machine or drive element in accordance with EN 60204-1.
5. When using the safety relay, take into consideration the maximum permissible number of cycles for observing the SIL/PL safety characteristics in the specific application. The safety characteristics can be found in the AH EN SAFETY CHARACTERISTICS application note or the SISTEMA library.

Application manual for PSRclassic and PSRmultifunction, and the modular safety relay system

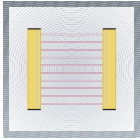

5.2.2 PSR-ESD/4x1/30 up to PL e/SIL 3

Two-channel light grid monitoring with manual reset (ESPE type 4)

<b>Order No.</b>	2981800 with screw connection 2981813 with spring-cage connection
<b>Technical data</b>	<ul style="list-style-type: none"> <li>- 24 V DC</li> <li>- 2 undelayed enabling current paths, 2 delayed enabling current paths</li> <li>- Adjustable delay time (0 s ... 30 s)</li> <li>- Manual start or autostart</li> <li>- Basic insulation</li> <li>- Cat. 4/PLe in accordance with EN ISO 13849-1, SILCL 3 in accordance with EN 62061</li> </ul>

Application example



- Two-channel light grid monitoring
- Cross-circuit detection via the light grid
- Manual reset (A1, S34)
- Feedback of contactor contacts K5 and K6 at S34
- Stop category 0
- Monitoring of external contactors
- Safety level of the example up to PL e (EN ISO 13849-1) and SIL 3 (EN 62061)

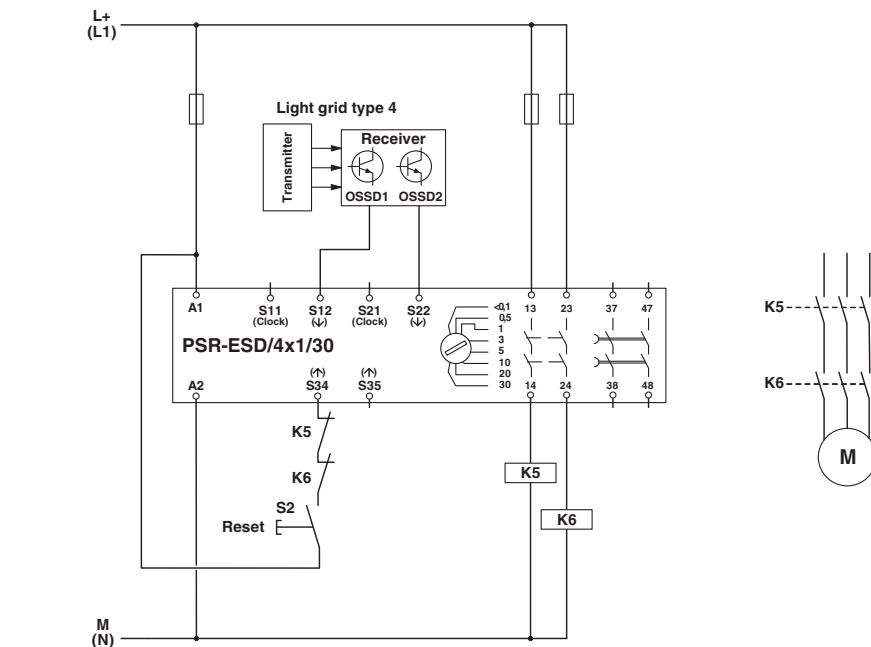
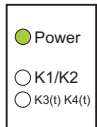





Figure 5-10 Two-channel light grid monitoring with manual reset PSR-ESD/4x1/30

## Application examples for conventional PSRclassic safety relays

## Function description

Start	Action	Result	Diagnostics
	1. The light grid is active, there is no object in the protective field.	Both OSSD signals from the light grid provide HIGH signals to enable circuit S12 and S22 of the safety relay.  The circuit is enabled via the reset button.	
	2. Press reset button S2.	Contactors K5 and K6 are activated and the mirror contacts (N/C contacts of K5 and K6) in the reset circuit are opened.	
Stop	Action	Result	Diagnostics
	1. The light grid is interrupted, there is an object in the protective field.	The safety function is triggered by the interruption of the light grid and contactors K5 and K6 drop out.  In the reset circuit, the mirror contacts of K5 and K6 are closed.	
		After the preset time, the dropout delayed enable contacts of the safety relay drop out.	

For additional diagnostic descriptions, please refer to Section 8.

## Notes on the application example

1. The light grid (ESPE) must meet type 4 requirements of standard EN 61496-1.
2. Make sure that the signal generator (e.g., light grid) and the safety relay have the same ground potential.
3. Contactors K5 and K6 have mirror contacts in accordance with EN 60947-4-1.
4. Stop category 0 describes an immediate stop by removal of power by interrupting a machine or drive element in accordance with EN 60204-1.
5. When using the safety relay, take into consideration the maximum permissible number of cycles for observing the SIL/PL safety characteristics in the specific application. The safety characteristics can be found in the AH EN SAFETY CHARACTERISTICS application note or the SISTEMA library.

Application manual for PSRclassic and PSRmultifunction, and the modular safety relay system

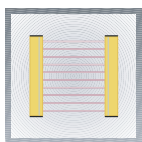

### 5.2.3 PSR-ESAM4/8x1/1x2 up to PL e/SIL 3

#### Two-channel light grid monitoring with automatic reset (ESPE type 4)

<b>Order No.</b>	2963912 with screw connection 2963996 with spring-cage connection
<b>Technical data</b>	<ul style="list-style-type: none"> <li>- 24 V AC/DC</li> <li>- 8 enabling current paths, 1 signaling current path</li> <li>- Monitored manual start or autostart</li> <li>- Reinforced insulation/basic insulation</li> <li>- Cat. 4/PLe in accordance with EN ISO 13849-1, SILCL 3 in accordance with EN 62061</li> </ul>

#### Application example



- Two-channel light grid monitoring
- Cross-circuit detection via the light grid
- Manual reset (S33, S35)
- Feedback of contactor contacts K3 and K4 at S33 and S35
- Stop category 0
- Monitoring of external contactors
- Safety level of the example up to PL e (EN ISO 13849-1) and SIL 3 (EN 62061)

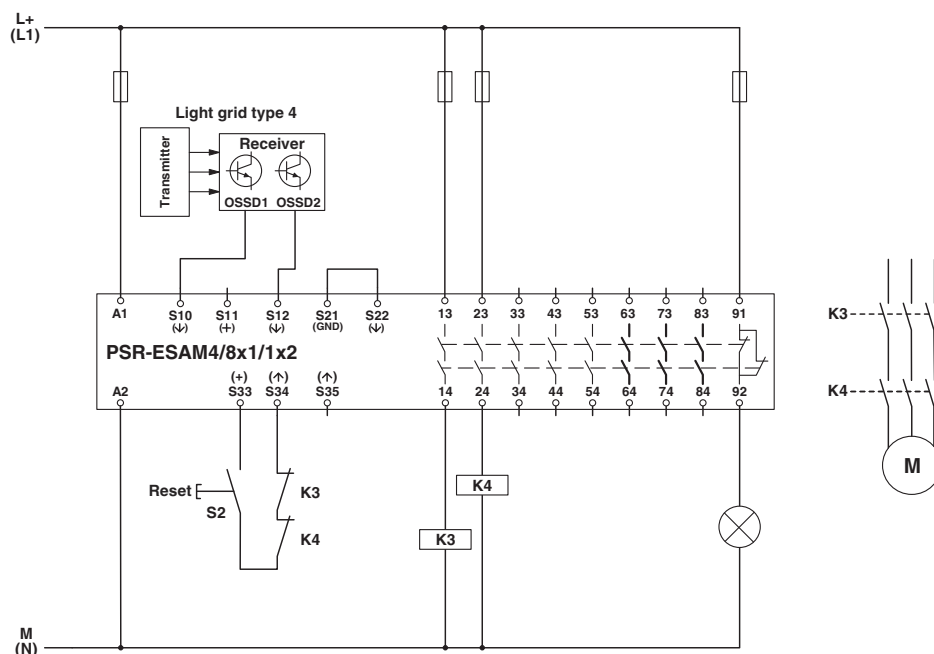



Figure 5-11 Two-channel light grid monitoring with automatic reset PSR-ESAM4/8x1/1x2

## Application examples for conventional PSRclassic safety relays

### Function description

Start	Action	Result	Diagnostics
	1. The light grid is active, there is no object in the protective field.	Both OSSD signals from the light grid provide HIGH signals to enable circuit S10 and S12 of the safety relay. Contactors K3 and K4 are activated and the mirror contacts (N/C contacts of K3 and K4) in the reset circuit are opened.	
Stop	Action	Result	Diagnostics
	1. The light grid is interrupted, there is an object in the protective field.	The safety function is triggered by the interruption of the light grid and contactors K3 and K4 drop out.  In the reset circuit, the mirror contacts of K3 and K4 are closed.	

For additional diagnostic descriptions, please refer to Section 8.

### Notes on the application example

1. The light grid (ESPE) must meet type 4 requirements of standard EN 61496-1.
2. Make sure that the signal generator (e.g., light grid) and the safety relay have the same ground potential.
3. Contactors K3 and K4 have mirror contacts in accordance with EN 60947-4-1.
4. Stop category 0 describes an immediate stop by removal of power by interrupting a machine or drive element in accordance with EN 60204-1.
5. A restart should only occur automatically if there is no hazardous situation. Please refer to the detailed information in standard EN ISO 12100, Section 6.3.3.2.5.
6. When using the safety relay, take into consideration the maximum permissible number of cycles for observing the SIL/PL safety characteristics in the specific application. The safety characteristics can be found in the AH EN SAFETY CHARACTERISTICS application note or the SISTEMA library.

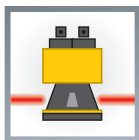

### 5.2.4 PSR-ESD/4x1/30 up to PL d/SIL 2

#### Two-channel laser scanner monitoring with manual reset (ESPE type 3)

<b>Order No.</b>	2981800 with screw connection 2981813 with spring-cage connection
<b>Technical data</b>	<ul style="list-style-type: none"> <li>- 24 V AC/DC</li> <li>- 2 undelayed enabling current paths, 2 delayed enabling current paths</li> <li>- Monitored manual start or autostart</li> <li>- Basic insulation</li> <li>- Cat. 4/PLe in accordance with EN ISO 13849-1, SILCL 3 in accordance with EN 62061</li> </ul>

#### Application example



- Two-channel laser scanner monitoring
- Cross-circuit detection via laser scanner
- Manual reset (A1, S34)
- Feedback of contactor contacts K5 and K6 at S34
- Stop category 0
- Monitoring of external contactors
- Safety level of the example up to PL d (EN ISO 13849-1) and SIL 2 (EN 62061)

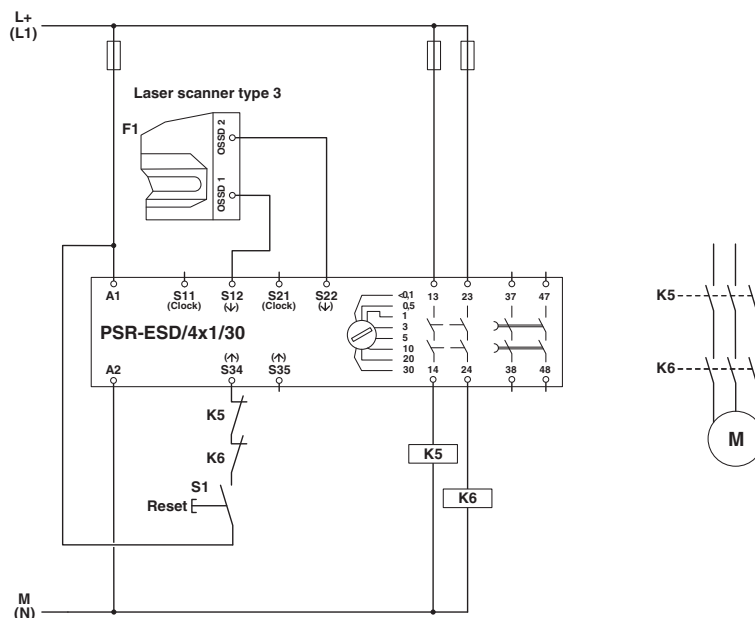

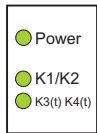

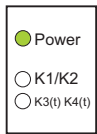

Figure 5-12 Two-channel laser scanner monitoring with manual reset PSR-ESD/4x1/30

## Application examples for conventional PSRclassic safety relays

## Function description

Start	Action	Result	Diagnostics
	1. The laser scanner is active, there is no object in the protective field.	Both OSSD signals from the laser scanner provide HIGH signals to enable circuit S12 and S22 of the safety relay. The circuit is enabled via the reset button.	
	2. Press reset button S1.	Contactors K5 and K6 are activated and the mirror contacts (N/C contacts of K5 and K6) in the reset circuit are opened.	
Stop	Action	Result	Diagnostics
	1. The laser scanner is interrupted, there is an object in the protective field.	The safety function is triggered by the interruption of the laser scanner and contactors K5 and K6 drop out. In the reset circuit, the mirror contacts of K5 and K6 are closed.	
		After the preset time, the dropout delayed enable contacts of the safety relay drop out.	

For additional diagnostic descriptions, please refer to Section 8.

## Notes on the application example

1. The laser scanner must meet type 3 requirements of standard EN 61496-3.
2. Make sure that the signal generator (e.g., light grid) and the safety relay have the same ground potential.
3. Contactors K5 and K6 have mirror contacts in accordance with EN 60947-4-1.
4. Stop category 0 describes an immediate stop by removal of power by interrupting a machine or drive element in accordance with EN 60204-1.
5. When using the safety relay, take into consideration the maximum permissible number of cycles for observing the SIL/PL safety characteristics in the specific application. The safety characteristics can be found in the AH EN SAFETY CHARACTERISTICS application note or the SISTEMA library.

## Application manual for PSRclassic and PSRmultifunction, and the modular safety relay system

---

### 5.3 Movable guards

Guards with an interlocking device are designed for executing the following functions together with the machine control system:

- The hazardous machine functions “covered” by the guard cannot be performed until the guard is closed.
- If the guard is opened while the hazardous machine functions are operating, a stop command is triggered.
- The hazardous machine functions “covered” by the guard can be performed as soon as the guard is closed. Closing the guard does not automatically initiate the hazardous machine functions.

Interlocking devices can combine various functions and have a position monitoring function for guards. The interlocking device detects whether or not the guard is closed and issues a stop command. Some interlocking devices have a guard locking function which locks the guard while the hazardous machine functions are performed. A separate status monitoring function for guard locking devices monitors whether the guard locking device is locked and generates a corresponding output signal.

#### Relevant standards

- EN 14119 Safety of machinery - Interlocking devices associated with guards

Application manual for PSRclassic and PSRmultifunction, and the modular safety relay system

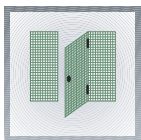

### 5.3.1 PSR-ESA4/2x1/1x2 up to PL e/SIL 3

Two-channel safety door monitoring with automatic reset (with cross-circuit detection)

<b>Order No.</b>	2963750 with screw connection 2963938 with spring-cage connection
<b>Technical data</b>	<ul style="list-style-type: none"> <li>- 24 V AC/DC</li> <li>- 2 enabling current paths, 1 signaling current path</li> <li>- Manual start or autostart</li> <li>- Reinforced insulation</li> <li>- Cat. 4/PLe in accordance with EN ISO 13849-1, SILCL 3 in accordance with EN 62061</li> </ul>

#### Application example



- Two-channel safety door monitoring with two position switches
- Cross-circuit detection
- Ground fault detection (S11, S12 only)
- Automatic reset (bridge S33, S34)
- Feedback of contactor contacts K3 and K4 at S33 and S34
- Stop category 0
- Monitoring of external contactors
- Safety level of the example up to PL e (EN ISO 13849-1) and SIL 3 (EN 62061)

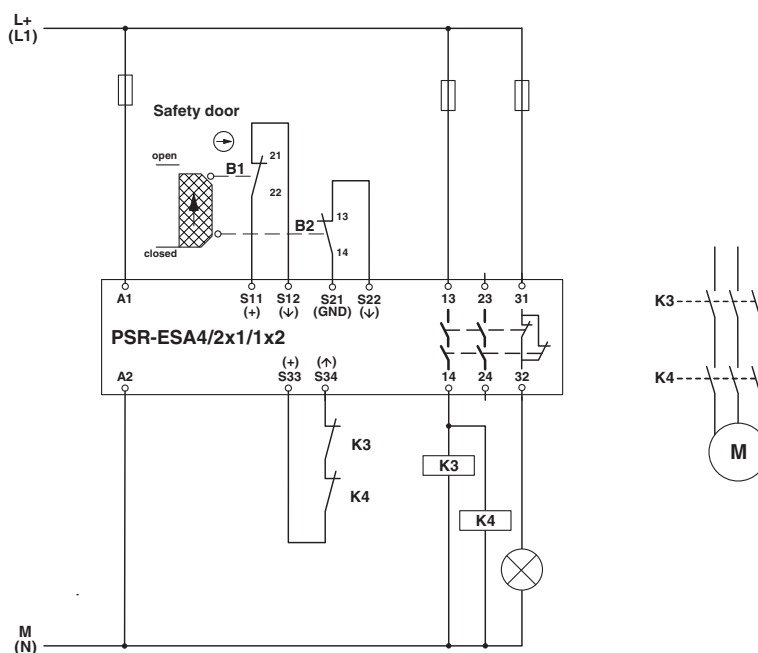
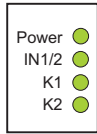



Figure 5-13 Two-channel safety door monitoring with automatic reset PSR-ESA4/2x1/1x2

## Application examples for conventional PSRclassic safety relays

### Function description

Start	Action	Result	Diagnostics
	1. Close the safety door.	The safety door circuit closes enable circuit S11, S12 and S21, S22 of the safety relay. Contactors K3 and K4 are activated and the mirror contacts (N/C contacts of K3 and K4) in the reset circuit are opened.	
Stop	Action	Result	Diagnostics
	1. Open the safety door.	The safety function is triggered and contactors K3 and K4 drop out. In the reset circuit, the mirror contacts of K3 and K4 are closed.	

For additional diagnostic descriptions, please refer to Section 8.

### Notes on the application example

1. The position switch is positive opening in accordance with EN 60947-5-1.
2. Contactors K3 and K4 have mirror contacts in accordance with EN 60947-4-1.
3. Stop category 0 describes an immediate stop by removal of power by interrupting a machine or drive element in accordance with EN 60204-1.
4. A restart should only occur automatically if there is no hazardous situation. Please refer to the detailed information in standard EN ISO 12100, Section 6.3.3.2.5.
5. Install the safety relay and contactors together in an installation space in accordance with EN 60204-1 (e.g., in the control cabinet). This prevents a cross-circuit at the output of the safety relay.
6. When using the safety relay, take into consideration the maximum permissible number of cycles for observing the SIL/PL safety characteristics in the specific application. The safety characteristics can be found in the AH EN SAFETY CHARACTERISTICS application note or the SISTEMA library.

Application manual for PSRclassic and PSRmultifunction, and the modular safety relay system

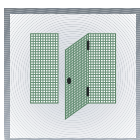

5.3.2 PSR-ESAM4/2x1/1x2 up to PL e/SIL 3

Two-channel safety door monitoring with manual reset (with cross-circuit detection)

<b>Order No.</b>	2900525 with screw connection
	2900526 with spring-cage connection
<b>Technical data</b>	- 24 V AC/DC
	- 2 enabling current paths, 1 signaling current path
	- Manual start or autostart
	- Reinforced insulation
	- Cat. 4/PLe in accordance with EN ISO 13849-1, SILCL 3 in accordance with EN 62061

Application example



- Two-channel safety door monitoring with one safety hinge switch
- Cross-circuit detection
- Ground fault detection (S11, S12 only)
- Manual reset (S12, S34)
- Feedback of contactor contacts K3 and K4 at S34
- Stop category 0
- Monitoring of external contactors
- Safety level of the example up to PL e (EN ISO 13849-1) and SIL 3 (EN 62061)

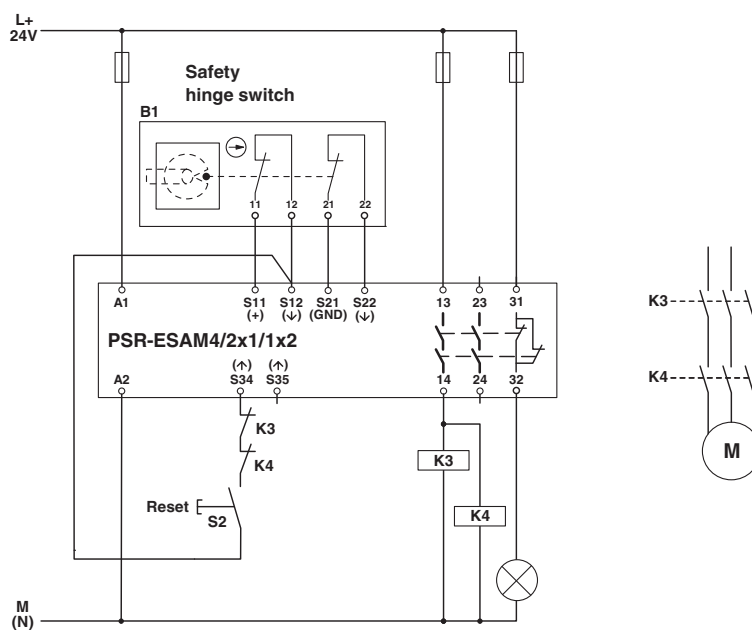
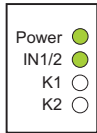

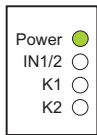

Figure 5-14 Two-channel safety door monitoring with manual reset PSR-ESAM4/2x1/1x2

## Application examples for conventional PSRclassic safety relays

### Function description

Start	Action	Result	Diagnostics
	1. Close the safety door.	The safety door circuit closes enable circuit S11, S12 and S21, S22 of the safety relay.  The circuit is enabled via the reset button.	
	2. Press reset button S2.	Contactors K3 and K4 are activated and the mirror contacts (N/C contacts of K3 and K4) in the reset circuit are opened.	
Stop	Action	Result	Diagnostics
	1. Open the safety door.	The safety function is triggered and contactors K3 and K4 drop out.  In the reset circuit, the mirror contacts of K3 and K4 are closed.	

For additional diagnostic descriptions, please refer to Section 8.

### Notes on the application example

1. When using safety hinge switches, observe the notes in standards EN 953, EN 1088, EN ISO 13857, and EN ISO 14119.
2. Contactors K3 and K4 have mirror contacts in accordance with EN 60947-4-1.
3. Stop category 0 describes an immediate stop by removal of power by interrupting a machine or drive element in accordance with EN 60204-1.
4. Install the safety relay and contactors together in an installation space in accordance with EN 60204-1 (e.g., in the control cabinet). This prevents a cross-circuit at the output of the safety relay.
5. When using the safety relay, take into consideration the maximum permissible number of cycles for observing the SIL/PL safety characteristics in the specific application. The safety characteristics can be found in the AH EN SAFETY CHARACTERISTICS application note or the SISTEMA library.

Application manual for PSRclassic and PSRmultifunction, and the modular safety relay system

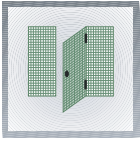

5.3.3 PSR-ESAM4/3x1/1x2 up to PL e/SIL 3

Two-channel safety door monitoring with manual reset (with cross-circuit detection)

<b>Order No.</b>	2981114 with screw connection 2981127 with spring-cage connection
<b>Technical data</b>	<ul style="list-style-type: none"> <li>- 24 - 230 V AC/DC</li> <li>- 3 enabling current paths, 1 signaling current path</li> <li>- Manual start or autostart</li> <li>- Reinforced insulation</li> <li>- Cat. 4/PLe in accordance with EN ISO 13849-1, SILCL 3 in accordance with EN 62061</li> </ul>

Application example



- Two-channel safety door monitoring with two position switches
- Cross-circuit detection
- Ground fault detection (S11, S12 only)
- Manual reset (S33, S34)
- Feedback of contactor contacts K3 and K4 at S33 and S34
- Stop category 0
- Monitoring of external contactors
- Safety level of the example up to PL e (EN ISO 13849-1) and SIL 3 (EN 62061)

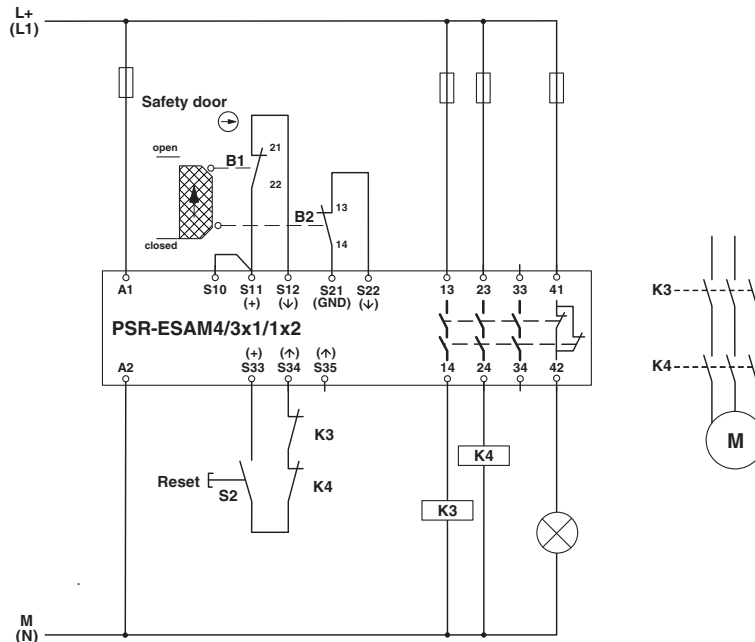
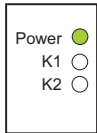



Figure 5-15 Two-channel safety door monitoring with manual reset PSR-ESAM4/3x1/1x2

## Application examples for conventional PSRclassic safety relays

### Function description

Start	Action	Result	Diagnostics
	1. Close the safety door.	The safety door circuit closes enable circuit S11, S12 and S21, S22 of the safety relay.  The circuit is enabled via the reset button.	
	2. Press reset button S2.	Contactors K3 and K4 are activated and the mirror contacts (N/C contacts of K3 and K4) in the reset circuit are opened.	
Stop	Action	Result	Diagnostics
	1. Open the safety door.	The safety function is triggered and contactors K3 and K4 drop out.  In the reset circuit, the mirror contacts of K3 and K4 are closed.	

For additional diagnostic descriptions, please refer to Section 8.

### Notes on the application example

1. The position switch is positive opening in accordance with EN 60947-5-1.
2. Contactors K3 and K4 have mirror contacts in accordance with EN 60947-4-1.
3. Stop category 0 describes an immediate stop by removal of power by interrupting a machine or drive element in accordance with EN 60204-1.
4. When using the safety relay, take into consideration the maximum permissible number of cycles for observing the SIL/PL safety characteristics in the specific application. The safety characteristics can be found in the AH EN SAFETY CHARACTERISTICS application note or the SISTEMA library.

Application manual for PSRclassic and PSRmultifunction, and the modular safety relay system

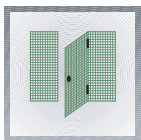

### 5.3.4 PSR-ESAM4/3x1/1x2/B up to PL d/SIL 2

Two-channel safety door monitoring with manual reset (with cross-circuit detection)

<b>Order No.</b>	2900509 with screw connection 2900510 with spring-cage connection
<b>Technical data</b>	<ul style="list-style-type: none"> <li>- 24 V AC/DC</li> <li>- 3 enabling current paths, 1 signaling current path</li> <li>- Manual start or autostart</li> <li>- Basic insulation</li> <li>- Cat. 4/PLe in accordance with EN ISO 13849-1, SILCL 3 in accordance with EN 62061</li> </ul>

**Application example**



- Two-channel safety door monitoring with one guard locking device
- Cross-circuit detection
- Ground fault detection (S11, S12 only)
- Manual reset (S12, S34)
- Feedback of contactor contacts K3 and K4 at S34
- Stop category 0
- Monitoring of external contactors
- Safety level of the example up to PL d (EN ISO 13849-1) and SIL 2 (EN 62061)

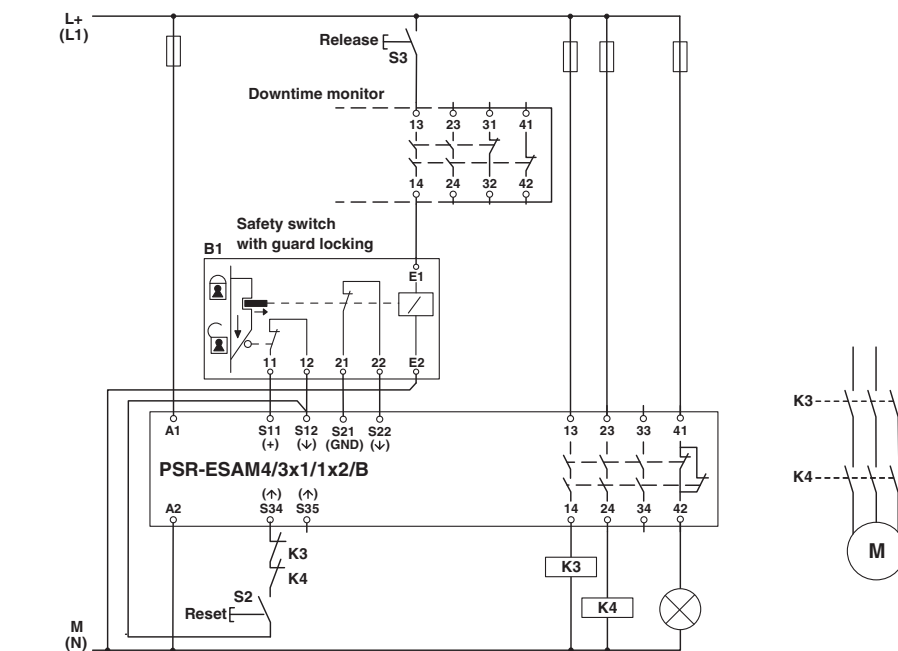
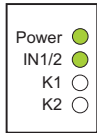
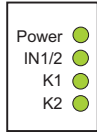
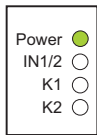

Figure 5-16 Two-channel safety door monitoring with manual reset PSR-ESAM4/3x1/1x2/B

## Application examples for conventional PSRclassic safety relays

### Function description

Start	Action	Result	Diagnostics
	1. Close and lock the safety door.	The safety door circuit closes enable circuit S11, S12 and S21, S22 of the safety relay.  The circuit is enabled via the reset button.	
	2. Press reset button S2.	Contactors K3 and K4 are activated and the mirror contacts (N/C contacts of K3 and K4) in the reset circuit are opened.	
Stop	Action	Result	Diagnostics
	1. Unlock guard locking B1 via button S3.	The safety function is triggered and contactors K3 and K4 drop out.	
	2. Open the safety door.	In the reset circuit, the mirror contacts of K3 and K4 are closed.	

For additional diagnostic descriptions, please refer to Section 8.

### Notes on the application example

1. The safety guard locking device is positive opening in accordance with EN 60947-5-1.
2. Contactors K3 and K4 have mirror contacts in accordance with EN 60947-4-1.
3. Stop category 0 describes an immediate stop by removal of power by interrupting a machine or drive element in accordance with EN 60204-1.
4. When using the safety relay, take into consideration the maximum permissible number of cycles for observing the SIL/PL safety characteristics in the specific application. The safety characteristics can be found in the AH EN SAFETY CHARACTERISTICS application note or the SISTEMA library.

Application manual for PSRclassic and PSRmultifunction, and the modular safety relay system

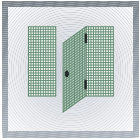

5.3.5 PSR-ESD/4x1/30 up to PL c/SIL 1

Two-channel safety door monitoring with dropout delayed contacts and automatic reset (with cross-circuit detection)

<b>Order No.</b>	2981800 with screw connection 2981813 with spring-cage connection
<b>Technical data</b>	<ul style="list-style-type: none"> <li>- 24 V DC</li> <li>- 2 undelayed enabling current paths, 2 delayed enabling current paths</li> <li>- Adjustable delay time (0 s ... 30 s)</li> <li>- Manual start or autostart</li> <li>- Basic insulation</li> <li>- Cat. 4/PLe in accordance with EN ISO 13849-1, SILCL 3 in accordance with EN 62061</li> </ul>

Application example



- Two-channel safety door monitoring with two position switches and controlled stop
- Cross-circuit detection/ground fault detection
- Automatic reset (A1, S35)
- Feedback of contactor contacts K5 and K6 at S35
- Stop category 1
- Monitoring of external contactors
- Safety level of the example up to PL c (EN ISO 13849-1) and SIL 1 (EN 62061)

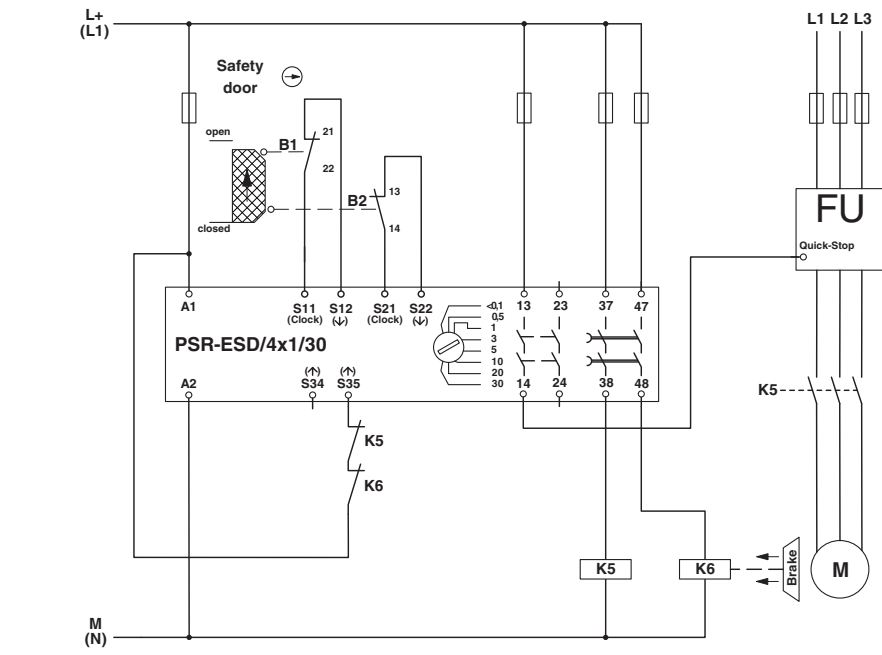





Figure 5-17 Two-channel safety door monitoring with dropout delayed contacts and automatic reset PSR-ESD/4x1/30

## Application examples for conventional PSRclassic safety relays

## Function description

Start	Action	Result	Diagnostics
	1. Close the safety door.	The safety door circuit closes enable circuit S11, S12 and S21, S22 of the safety relay. Contactors K5 and K6 are activated and the mirror contacts (N/C contacts of K5 and K6) in the reset circuit are opened.	
Stop	1. Open the safety door.	The safety door is opened and contacts 13, 14 of the safety relay open immediately, which initiates an automatic "quick stop" at the FI.	
		After the preset time, the dropout delayed contacts 37, 38 and 47, 48 deactivate contactors K5 and K6 with a time delay. After the delayed deactivation, the mains supply to the motor is disconnected from the FI and at the same time brake unlocking is switched off so that the brake blocks the drive. In the reset circuit, the mirror contacts of K5 and K6 are closed.	

For additional diagnostic descriptions, please refer to Section 8.

## Notes on the application example

1. The position switch is positive opening in accordance with EN 60947-5-1.
2. Contactors K5 and K6 have mirror contacts in accordance with EN 60947-4-1.
3. Stop category 1 describes a controlled stop with power available in accordance with EN 60204-1. This means that the power is only switched off after the connected machine has stopped.
4. A restart should only occur automatically if there is no hazardous situation. Please refer to the detailed information in standard EN ISO 12100, Section 6.3.3.2.5.
5. The (holding) brake is not part of the safety function.
6. When the safety door has been opened, it should not be possible to access the danger zones (observe safety distance) during the controlled stop (of the hazardous movement).
7. Install the safety relay and contactors together in an installation space in accordance with EN 60204-1 (e.g., in the control cabinet). This prevents a cross-circuit at the output of the safety relay.
8. When using the safety relay, take into consideration the maximum permissible number of cycles for observing the SIL/PL safety characteristics in the specific application. The safety characteristics can be found in the AH EN SAFETY CHARACTERISTICS application note or the SISTEMA library.
9. Make sure that the frequency converter and the safety relay have the same ground potential.

Application manual for PSRclassic and PSRmultifunction, and the modular safety relay system

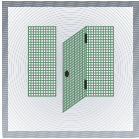

5.3.6 PSR-ESD/4x1/30 up to PL e/SIL 3

Two-channel safety door monitoring with dropout delayed contacts and manual reset (with cross-circuit detection)

<b>Order No.</b>	2981800 with screw connection 2981813 with spring-cage connection
<b>Technical data</b>	<ul style="list-style-type: none"> <li>- 24 V DC</li> <li>- 2 undelayed enabling current paths, 2 delayed enabling current paths</li> <li>- Adjustable delay time (0 s ... 30 s)</li> <li>- Monitored manual start or autostart</li> <li>- Basic insulation</li> <li>- Cat. 4/PLe in accordance with EN ISO 13849-1, SILCL 3 in accordance with EN 62061</li> </ul>

Application example



- Two-channel non-contact safety switch
- Cross-circuit detection via non-contact safety switch
- Manual reset (A1, S34)
- Feedback of contactor contacts K5 and K6 at S34
- Stop category 0
- Monitoring of external contactors
- Safety level of the example up to PL e (EN ISO 13849-1) and SIL 3 (EN 62061)

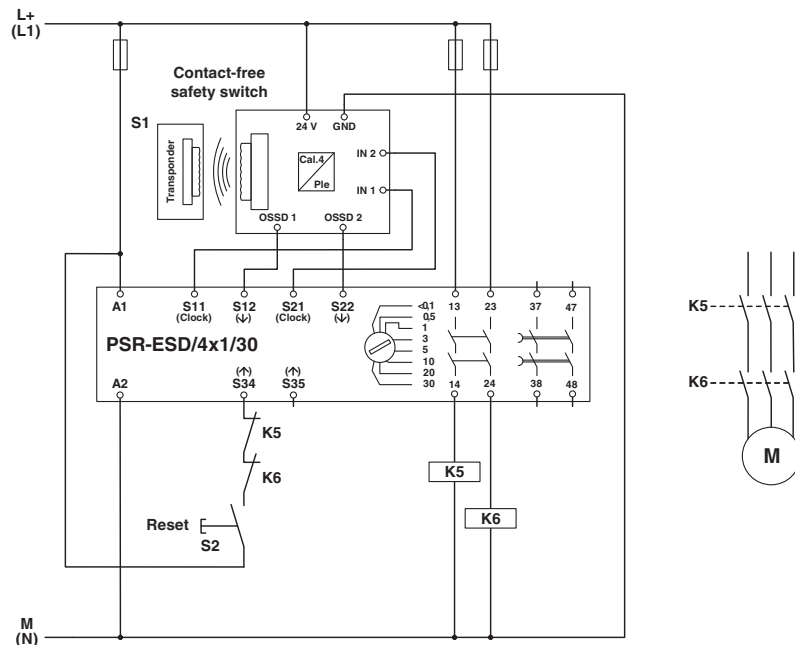

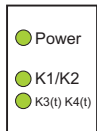



Figure 5-18 Two-channel safety door monitoring with dropout delayed contacts and manual reset  
PSR-ESD/4x1/30

Application examples for conventional PSRclassic safety relays

Function description

Start	Action	Result	Diagnostics
	1. Close the safety door.	The safety door circuit closes enable circuit S12 and S22 of the safety relay.	
	2. Press reset button S2.	Contactors K5 and K6 are activated and the mirror contacts (N/C contacts of K5 and K6) in the reset circuit are opened.	
Stop	Action	Result	Diagnostics
	1. Open the safety door.	The safety function is triggered and contactors K5 and K6 drop out. In the reset circuit, the mirror contacts of K5 and K6 are closed.	
		After the preset time, the dropout delayed enable contacts of the safety relay drop out.	

For additional diagnostic descriptions, please refer to Section 8.

Notes on the application example

1. Contactors K5 and K6 have mirror contacts in accordance with EN 60947-4-1.
2. Stop category 0 describes an immediate stop by removal of power by interrupting a machine or drive element in accordance with EN 60204-1.
3. When using the safety relay, take into consideration the maximum permissible number of cycles for observing the SIL/PL safety characteristics in the specific application. The safety characteristics can be found in the AH EN SAFETY CHARACTERISTICS application note or the SISTEMA library.

Application manual for PSRclassic and PSRmultifunction, and the modular safety relay system

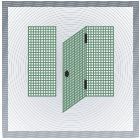

5.3.7 PSR-ESD/5x1/1x2/300 up to PL e/SIL 3

Two-channel safety door monitoring with dropout delayed contacts and manual reset (with cross-circuit detection)

<b>Order No.</b>	2981428 with screw connection 2981431 with spring-cage connection
<b>Technical data</b>	<ul style="list-style-type: none"> <li>- 24 V DC</li> <li>- 3 undelayed enabling current paths, 2 delayed enabling current paths, 1 signaling current path</li> <li>- Adjustable delay time (0.2 s ... 300 s)</li> <li>- Manual start or autostart</li> <li>- Reinforced insulation/basic insulation</li> </ul>

Application example



- Two-channel safety door monitoring with two position switches
- Cross-circuit detection/ground fault detection (S11, S12 only)
- Manual reset (S33, S34)
- Feedback of contactor contacts K5 ... K8 at Y1 and Y2
- Switch-off delay at K7 and K8
- Stop category 0/1
- Monitoring of external contactors
- Safety level of the example: drive 1 PL e (EN ISO 13849-1) and SIL 3 (EN 62061)
- Safety level of the example: drive 2 PL d (EN ISO 13849-1) and SIL 2 (EN 62061)

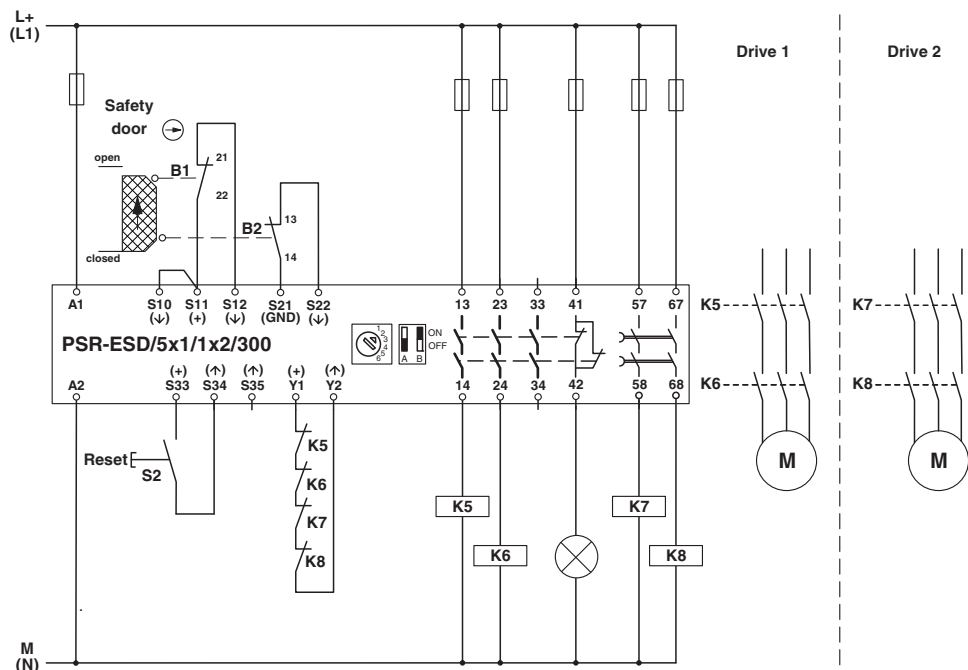
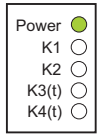
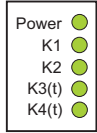
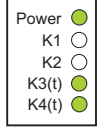
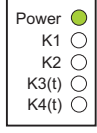

Figure 5-19 Two-channel safety door monitoring with dropout delayed contacts and manual reset  
PSR-ESD/5x1/1x2/300

## Application examples for conventional PSRclassic safety relays

## Function description

Start	Action	Result	Diagnostics
	1. Close the safety door.	The safety door circuit closes enable circuit S11, S12 and S21, S22 of the safety relay. Contactors K5 ... K8 are activated and the mirror contacts (N/C contacts of K5 ... K8) in the reset circuit are opened.	
	2. Press reset button S2.	Contactors K5 ... K8 are activated and the mirror contacts (N/C contacts of K5 ... K8) in the reset circuit (Y1, Y2) are opened.	
Stop	Action	Result	Diagnostics
	1. Open the safety door.	The safety function is triggered and contactors K5 and K6 drop out immediately.	
		After the preset time, the dropout delayed contacts 57, 58 and 67, 68 deactivate contactors K7 and K8 with a time delay. In the reset circuit, the mirror contacts of K5 ... K8 are closed.	

For additional diagnostic descriptions, please refer to Section 8.

## Notes on the application example

1. The position switch is positive opening in accordance with EN 60947-5-1.
2. Contactors K5, K6, K7, and K8 have mirror contacts in accordance with EN 60947-4-1.
3. Stop category 0 describes an immediate stop by removal of power by interrupting a machine or drive element in accordance with EN 60204-1.
4. Stop category 1 describes a controlled stop with power available in accordance with EN 60204-1. This means that the power is only switched off after the connected machine has stopped.
5. When using the safety relay, take into consideration the maximum permissible number of cycles for observing the SIL/PL safety characteristics in the specific application. The safety characteristics can be found in the AH EN SAFETY CHARACTERISTICS application note or the SISTEMA library.

Application manual for PSRclassic and PSRmultifunction, and the modular safety relay system

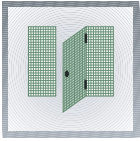

5.3.8 PSR-ESL4/3x1/1x2/B up to PL d/SIL 2

Two-channel, non-equivalent safety door monitoring with manual reset

<b>Order No.</b>	2981059 with screw connection 2981062 with spring-cage connection
<b>Technical data</b>	<ul style="list-style-type: none"> <li>- 24 V DC</li> <li>- 3 enabling current paths, 1 signaling current path</li> <li>- Monitored manual start or autostart</li> <li>- Basic insulation</li> <li>- Cat. 4/PLe in accordance with EN ISO 13849-1, SILCL 3 in accordance with EN 62061</li> </ul>

Application example



- Two-channel, non-equivalent safety door monitoring with two position switches
- Manual reset (S33, S34)
- Feedback of contactor contacts K3 and K4 at S33 and S34
- Stop category 0
- Monitoring of external contactors
- Safety level of the example up to PL d (EN ISO 13849-1) and SIL 2 (EN 62061)

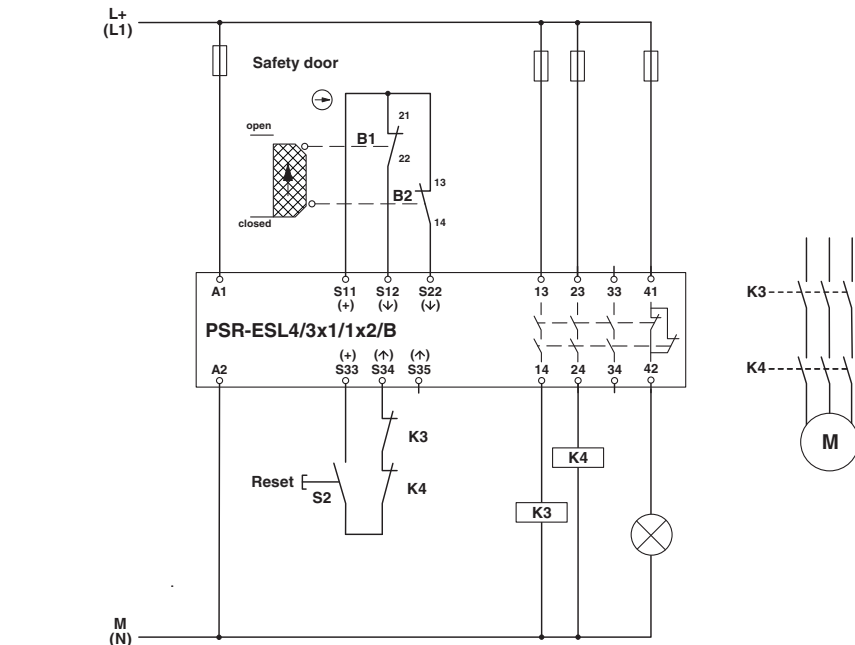
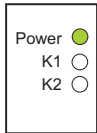



Figure 5-20 Two-channel safety door monitoring with manual reset PSR-ESL4/3x1/1x2/B

## Application examples for conventional PSRclassic safety relays

### Function description

Start	Action	Result	Diagnostics
	1. Close the safety door.	The safety door circuit closes enable circuit S11, S12, and S11, S22 of the safety relay. The circuit is enabled via the reset button.	
	2. Press reset button S2.	Contactors K3 and K4 are activated and the mirror contacts (N/C contacts of K3 and K4) in the reset circuit are opened.	
Stop	Action	Result	Diagnostics
	1. Open the safety door.	The safety function is triggered and contactors K3 and K4 drop out. In the reset circuit, the mirror contacts of K3 and K4 are closed.	

For additional diagnostic descriptions, please refer to Section 8.

### Notes on the application example

1. The connecting cables for the position switches in the sensor circuit (safety door switch) should either be laid separately or protected against mechanical damage.
2. The position switch is positive opening in accordance with EN 60947-5-1.
3. Contactors K3 and K4 have mirror contacts in accordance with EN 60947-4-1.
4. Stop category 0 describes an immediate stop by removal of power by interrupting a machine or drive element in accordance with EN 60204-1.
5. When using the safety relay, take into consideration the maximum permissible number of cycles for observing the SIL/PL safety characteristics in the specific application. The safety characteristics can be found in the AH EN SAFETY CHARACTERISTICS application note or the SISTEMA library.

## Application manual for PSRclassic and PSRmultifunction, and the modular safety relay system

---

## 5.4 Enable switch

An additional manually actuated device that is used together with a startup control, and that permits machine operation when continuously actuated. Enable devices are frequently used together with emergency stop devices for the temporary suspension of safety functions. Simply pressing an enable switch must not start machine operation (see EN 60204-1). The hazardous movement should only be triggered by activating an additional control device.

Enable devices with the following properties should be selected:

- Designed according to ergonomic principles

**a) For a type with two position settings:**

- Position 1: off function of the switch (actuator is not operated)
- Position 2: enable function (actuator is operated)

**a) For a type with three position settings:**

- Position 1: off function of the switch (actuator is not operated)
- Position 2: enable function (actuator is operated and in its mid position)
- Position 3: off function (actuator is operated past its mid position)
- Returning from position 3 to position 2 does not activate the enable function.

Application manual for PSRclassic and PSRmultifunction, and the modular safety relay system



5.4.1 PSR-ESAM4/2x1/1x2 up to PL e/SIL 3

Three-stage enable switch monitoring with automatic reset (with cross-circuit detection)

<b>Order No.</b>	2900525 with screw connection 2900526 with spring-cage connection
<b>Technical data</b>	<ul style="list-style-type: none"> <li>- 24 V AC/DC</li> <li>- 2 enabling current paths, 1 signaling current path</li> <li>- Manual start or autostart</li> <li>- Reinforced insulation</li> <li>- Cat. 4, PL e in accordance with EN ISO 13849-1, SILCL 3 in accordance with EN 62061</li> </ul>

Application example



- Three-stage enable switch monitoring
- Cross-circuit detection
- Ground fault detection (S11, S12 only)
- Automatic reset (S12, S35)
- Feedback of contactor contacts K3 and K4 at S35
- Stop category 0
- Monitoring of external contactors
- Safety level of the example up to PL e (EN ISO 13849-1) and SIL 3 (EN 62061)

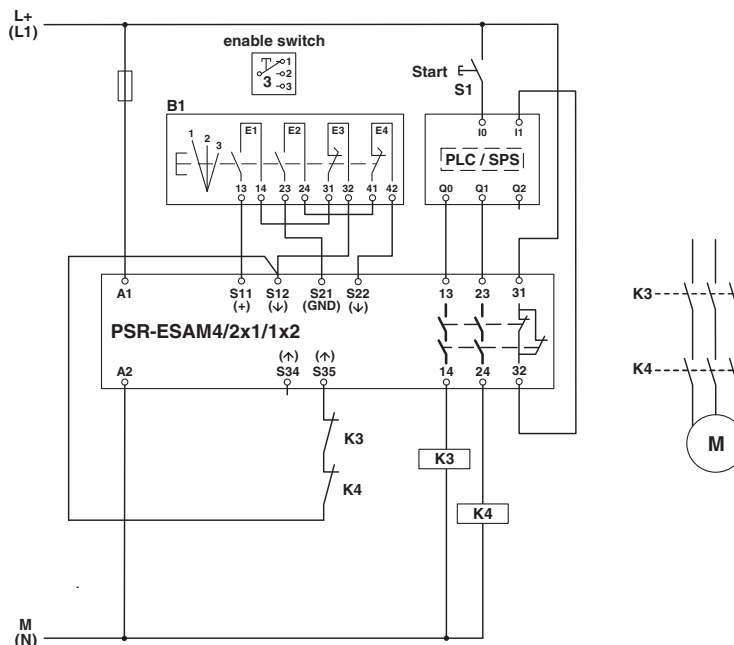

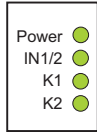
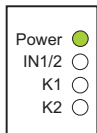

Figure 5-21 Three-stage enable switch monitoring with automatic reset PSR-ESAM4/2x1/1x2

## Application examples for conventional PSRclassic safety relays

### Function description

Start	Action	Result	Diagnostics
	1. Enable switch, stage 1 (not activated)	The circuit is enabled via the enable switch.	
	2. Enable switch, stage 2 (enable)	The enable switch closes enable circuit S11, S12 and S21, S22 of the safety relay. Contactors K3 and K4 are activated and the mirror contacts (N/C contacts of K3 and K4) in the reset circuit are opened.	
Stop	Action	Result	Diagnostics
	1. Enable switch, stage 3 (pushed through)	The safety function is triggered and contactors K3 and K4 drop out immediately.  In the reset circuit, the mirror contacts of K3 and K4 are closed.	

For additional diagnostic descriptions, please refer to Section 8.

### Notes on the application example

1. When using enable switches, observe the notes in standards EN 60204-1 and EN ISO 10218.
2. Contactors K3 and K4 have mirror contacts in accordance with EN 60947-4-1.
3. Stop category 0 describes an immediate stop by removal of power by interrupting a machine or drive element in accordance with EN 60204-1.
4. A restart (after a stop from stage 3 of the enable switch) should only occur automatically if there is no hazardous situation.
5. When using the safety relay, take into consideration the maximum permissible number of cycles for observing the SIL/PL safety characteristics in the specific application. The safety characteristics can be found in the AH EN SAFETY CHARACTERISTICS application note or the SISTEMA library.

Application manual for PSRclassic and PSRmultifunction, and the modular safety relay system



### 5.4.2 PSR-ESAM4/3x1/1x2/B up to PL e/SIL 3

Two-stage enable switch monitoring with manual reset (with cross-circuit detection)

<b>Order No.</b>	2900509 with screw connection 2900510 with spring-cage connection
<b>Technical data</b>	<ul style="list-style-type: none"> <li>- 24 V AC/DC</li> <li>- 3 enabling current paths, 1 signaling current path</li> <li>- Manual start or autostart</li> <li>- Basic insulation</li> <li>- Cat. 4, PL e in accordance with EN ISO 13849-1, SILCL 3 in accordance with EN 62061</li> </ul>

#### Application example



- Two-stage enable switch monitoring
- Cross-circuit detection
- Ground fault detection (S11, S12 only)
- Manual reset (S12, S34)
- Feedback of contactor contacts K3 and K4 at S34
- Stop category 0
- Monitoring of external contactors
- Safety level of the example up to PL e (EN ISO 13849-1) and SIL 3 (EN 62061)

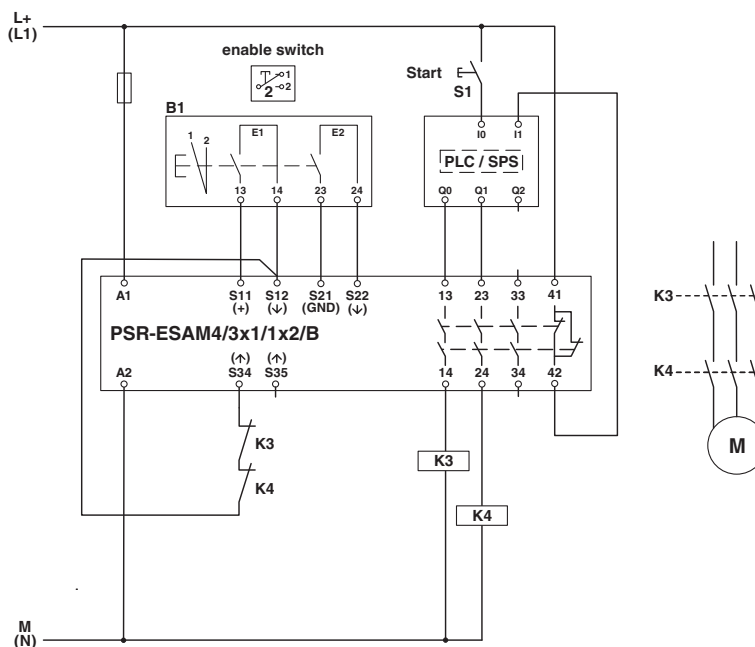
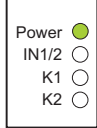

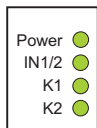



Figure 5-22 Two-stage enable switch monitoring with manual reset PSR-ESAM4/3x1/1x2/B

## Application examples for conventional PSRclassic safety relays

### Function description

Start	Action	Result	Diagnostics
	1. Enable switch, stage 1 (not activated)	The circuit is enabled via the enable switch.	
	2. Enable switch, stage 2 (enable)	The circuit is enabled via the reset button.	
	3. Press reset button S2	Contactors K3 and K4 are activated and the mirror contacts (N/C contacts of K3 and K4) in the reset circuit are opened.	
Stop	Action	Result	Diagnostics
	1. Enable switch, stage 1 (not activated)	<p>The safety function is triggered and contactors K3 and K4 drop out immediately.</p> <p>In the reset circuit, the mirror contacts of K3 and K4 are closed.</p>	

For additional diagnostic descriptions, please refer to Section 8.

### Notes on the application example

1. When using enable switches, observe the notes in standards EN 60204-1 and EN ISO 10218.
2. Contactors K3 and K4 have mirror contacts in accordance with EN 60947-4-1.
3. Stop category 0 describes an immediate stop by removal of power by interrupting a machine or drive element in accordance with EN 60204-1.
4. Depending on the level of risk, the use of a two-stage enable switch may only be permitted together with an emergency stop device.
5. When using the safety relay, take into consideration the maximum permissible number of cycles for observing the SIL/PL safety characteristics in the specific application. The safety characteristics can be found in the AH EN SAFETY CHARACTERISTICS application note or the SISTEMA library.

Application manual for PSRclassic and PSRmultifunction, and the modular safety relay system



5.4.3 PSR-ESAM4/2x1/1x2 up to PL e/SIL 3

Three-stage enable switch with two-channel emergency stop monitoring (with cross-circuit detection)

<b>Order No.</b>	2900525 with screw connection 2900526 with spring-cage connection
<b>Technical data</b>	<ul style="list-style-type: none"> <li>- 24 V AC/DC</li> <li>- 2 enabling current paths, 1 signaling current path</li> <li>- Manual start or autostart</li> <li>- Reinforced insulation</li> <li>- Cat. 4, PL e in accordance with EN ISO 13849-1, SILCL 3 in accordance with EN 62061</li> </ul>

Application example



- Three-stage enable switch monitoring
- Two-channel emergency stop monitoring
- Cross-circuit detection
- Ground fault detection (S11, S12 only)
- Manual reset (S12, S34) at safety relay KS1
- Feedback of contactor contacts K3 and K4 at S34 at safety relay KS1
- Automatic reset (S12, S35) at safety relay KS2
- Feedback of contactor contacts K5 and K6 at S35 at safety relay KS2
- Stop category 0
- Monitoring of external contactors
- Safety level of the example up to PL e (EN ISO 13849-1) and SIL 3 (EN 62061)

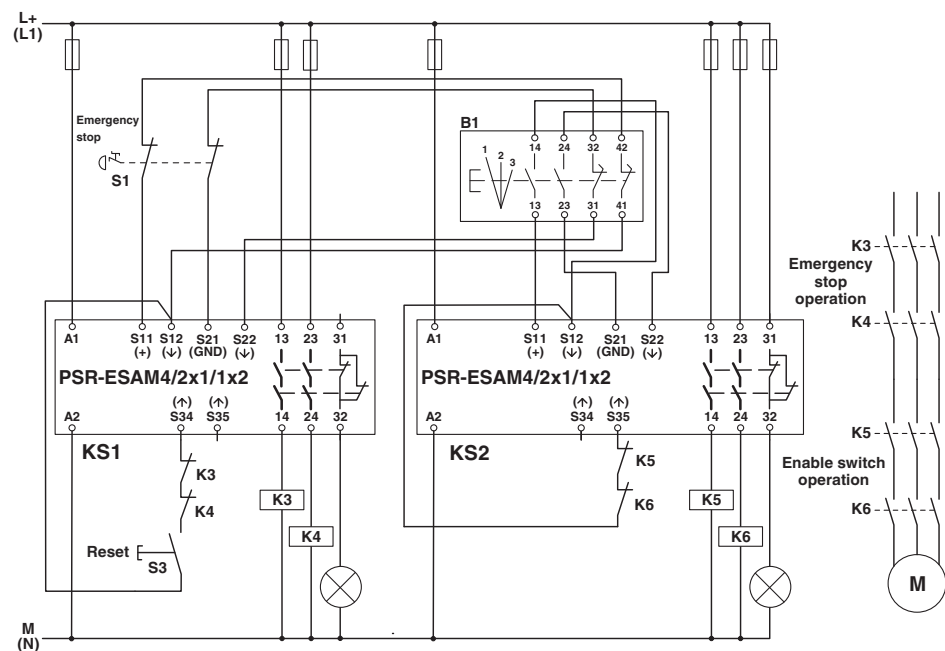

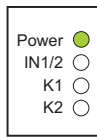



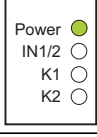
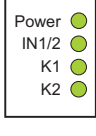
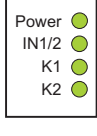
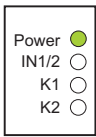
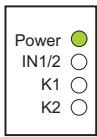

Figure 5-23 Three-stage enable switch with two-channel emergency stop monitoring PSR-ESAM4/2x1

Application examples for conventional PSRclassic safety relays

Function description

Start	Action	Result	Diagnostics, KS1	Diagnostics, KS2
	1. Unlock emergency stop button S1.	The emergency stop circuit supplies the safety relay (KS1). The circuit is enabled via the reset button (S3).		
	2. Press reset button S3.	Contactors K3 and K4 are activated and the mirror contacts (N/C contacts of K3 and K4) in the reset circuit are opened.		
Enable function	1. Enable switch B1, stage 1 (not activated)	The circuit is enabled via the enable switch (B1).		
	2. Enable switch B1, stage 2 (enable)	The enable switch (B1) closes sensor circuit S11, S12 and S21, S22 at the second safety relay (KS2). The automatic reset function closes enabling current paths 13, 14 and 23, 24 at the second safety relay (KS2). Holding down the enable switch (B1) keeps the safety function at the first safety relay (KS1) active.		
Stop	Action	Result	Diagnostics, KS1	Diagnostics, KS2
	1. Enable switch, stage 3 (pushed through)	The safety function is triggered and contactors K3 ... K6 drop out immediately. In the reset circuit of both safety relays KS1 and KS2, the mirror contacts (N/C contacts of K3 ... K6) are closed.		

For additional diagnostic descriptions, please refer to Section 8.

Notes on the application example

1. The emergency stop control device is positive opening in accordance with EN 60947-5-1.
2. When using enable switches, observe the notes in standards EN 60204-1, EN ISO 10218, EN 1088, and EN ISO 13849-1.
3. Contactors K3, K4, K5, and K6 have mirror contacts in accordance with EN 60947-4-1.
4. Stop category 0 describes an immediate stop by removal of power by interrupting a machine or drive element in accordance with EN 60204-1.
5. When using the safety relay, take into consideration the maximum permissible number of cycles for observing the SIL/PL safety characteristics in the specific application. The safety characteristics can be found in the AH EN SAFETY CHARACTERISTICS application note or the SISTEMA library.

## Application manual for PSRclassic and PSRmultifunction, and the modular safety relay system

---

## 5.5 Two-hand control

According to EN 574, the simultaneity of two-hand control devices must be monitored to be  $< 0.5$  seconds. The time is reliably checked and evaluated by corresponding category type III modules.

Two-hand control devices are localized safety equipment. The operator must keep his/her hands on the control device during dangerous machine movements.

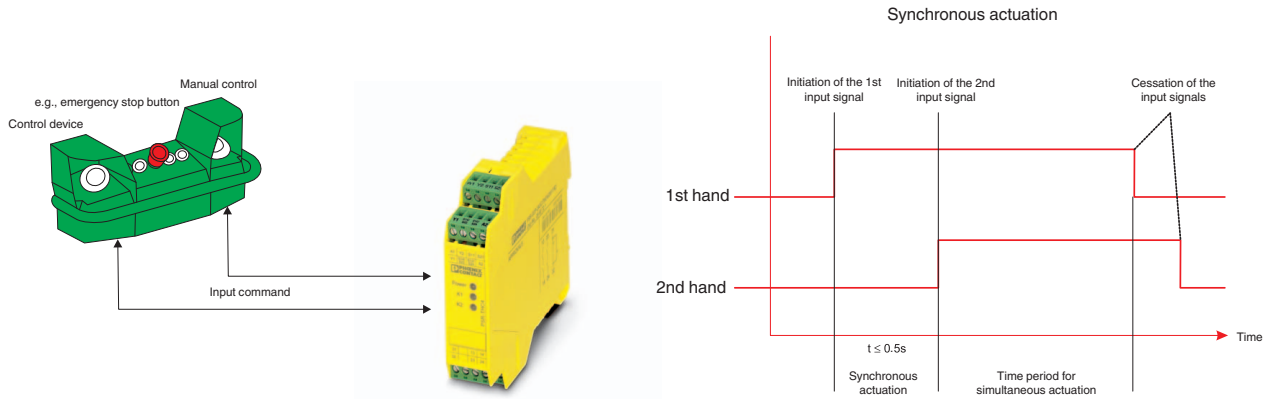
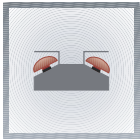

Figure 5-24 Two-hand control design

Application manual for PSRclassic and PSRmultifunction, and the modular safety relay system



5.5.1 PSR-THC4/2x1/1x2 up to PL e/SIL 3

Two-hand control device monitoring

<b>Order No.</b>	2963721 with screw connection 2963983 with spring-cage connection
<b>Technical data</b>	<ul style="list-style-type: none"> <li>- 24 V AC/DC</li> <li>- 2 enabling current paths, 1 signaling current path</li> <li>- Reinforced insulation</li> <li>- Two-hand and safety door control module in accordance with EN 574, type IIIC</li> <li>- Cat. 4, PL e in accordance with EN ISO 13849-1, SILCL 3 in accordance with EN 62061</li> </ul>

Application example



- Two-hand control device monitoring
- Cross-circuit detection/ground fault detection
- Automatic reset (Y1, Y2)
- Feedback of contactor contacts K3 and K4 at Y1 and Y2
- Monitoring of external contactors
- Safety level of the example up to PL e (EN ISO 13849-1) and SIL 3 (EN 62061)

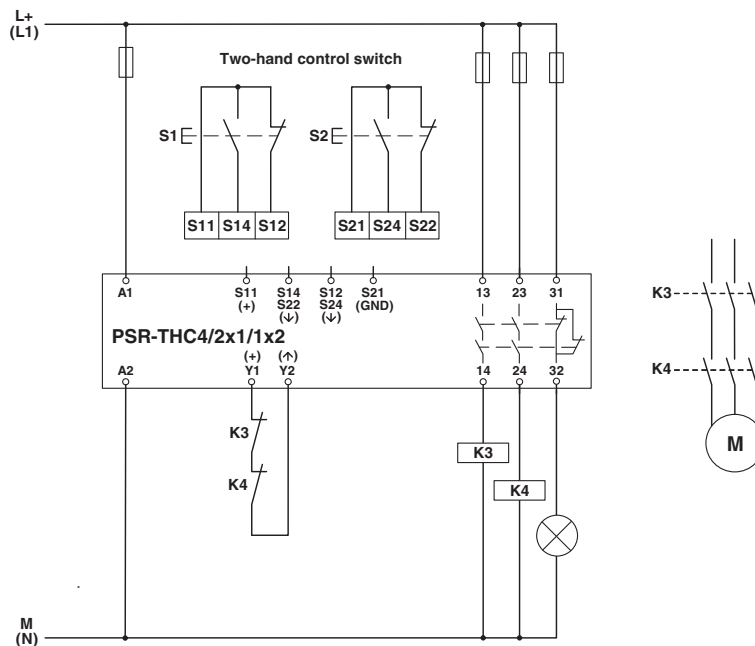
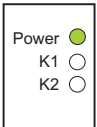

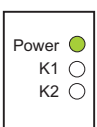

Figure 5-25 Two-hand control device monitoring PSR-THC4/2x1/1x2

## Application examples for conventional PSRclassic safety relays

### Function description

Start	Action	Result	Diagnostics
	1. Both buttons on the two-hand control device are not pressed.	The circuit is enabled via both buttons.	
	2. Press both buttons on the two-hand control device simultaneously.	Contactors K3 and K4 are activated and the mirror contacts (N/C contacts of K3 and K4) are opened.	
Stop	Action	Result	Diagnostics
	1. Both buttons on the two-hand control device are not actuated.	The safety function is triggered and contactors K3 and K4 drop out. The mirror contacts of K3 and K4 are closed.	

For additional diagnostic descriptions, please refer to Section 8.

### Notes on the application example

1. Two-hand operation in accordance with EN 574, type IIIC.
2. Contactors K3 and K4 have mirror contacts in accordance with EN 60947-4-1.
3. Stop category 0 describes an immediate stop by removal of power by interrupting a machine or drive element in accordance with EN 60204-1.
4. When using the safety relay, take into consideration the maximum permissible number of cycles for observing the SIL/PL safety characteristics in the specific application. The safety characteristics can be found in the AH EN SAFETY CHARACTERISTICS application note or the SISTEMA library.

## Application manual for PSRclassic and PSRmultifunction, and the modular safety relay system

---

## 5.6 Contact extension/force-guided contacts

Often more contacts are required than are available as standard. For these applications, the force-guided contact extension modules are used. They can be activated module-by-module, if required.

### Forced guidance

Standard EN 50205 makes a distinction between two groups of relays with force-guided contacts:

- Application type A: relay with a set of force-guided contacts
- Application type B: relay with a set of force-guided contacts and other contacts which are not force-guided, as well as a set of contacts with changeover contacts

The definition of “forced guidance” in accordance with EN 50205 is:

The relay must be designed so that none of the mechanically connected N/C contacts can close if an N/O contact is closed and that none of the mechanically connected N/O contacts can close if an N/C contact is closed.

These requirements apply for the entire service life of the relay and for reasonably foreseeable failure conditions.

The effects of reasonably foreseeable breaks and/or wear on parts of the elementary relay must not cause the (mechanical) forced guidance to fail.

During the entire relay service life specified by the manufacturer, the contact distances of opened contacts must be greater than 0.5 mm for a single N/C contact and greater than 0.3 mm each for a double interrupt. (Mechanical) forced guidance of contacts means that none of the N/C contacts may close if an N/O contact does not open for the non-activated relay. In addition, none of the N/O contacts may close if an N/C contact does not open when the relay is activated.

Application manual for PSRclassic and PSRmultifunction, and the modular safety relay system

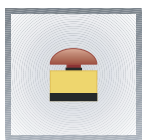

5.6.1 PSR-URM4/5x1/2x2 up to PL e/SIL 3

Two-channel emergency stop monitoring with contact extension and manual reset (with cross-circuit detection)

<b>Order No.</b>	2963734 with screw connection 2964005 with spring-cage connection
<b>Technical data</b>	<ul style="list-style-type: none"> <li>- 24 V AC/DC</li> <li>- 5 enabling current paths, 1 signaling current path, and 1 signal contact</li> <li>- Basic insulation</li> <li>- Cat. 4, PL e in accordance with EN ISO 13849-1, SILCL 3 in accordance with EN 62061</li> </ul>

Application example



- Two-channel emergency stop monitoring with contact extension
- Cross-circuit detection
- Ground fault detection (S11, S12 only)
- Manual reset (S12, S34) at safety relay KS1
- Feedback of contactor contacts K3 ... K8 and KS2 at S34 at safety relay KS1
- Stop category 0
- Monitoring of external contactors
- Safety level of the example up to PL e (EN ISO 13849-1) and SIL 3 (EN 62061)

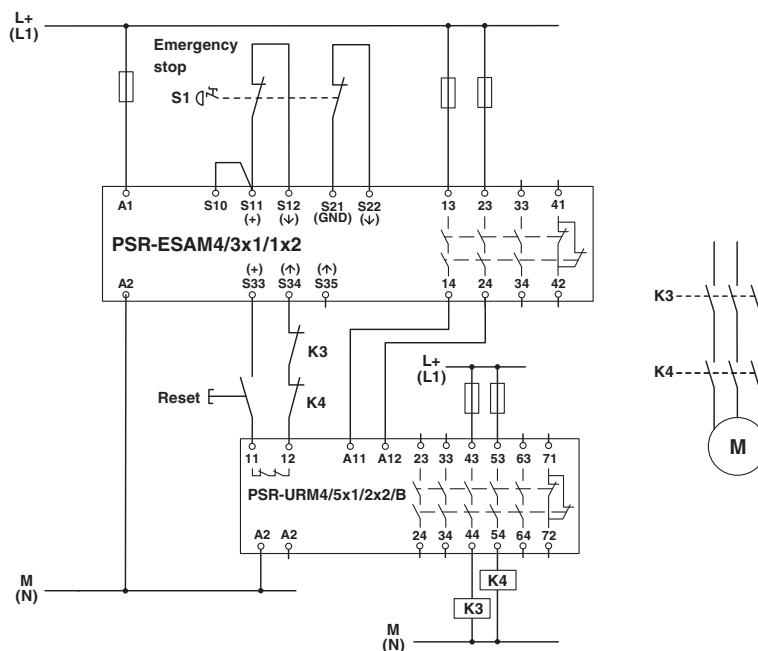
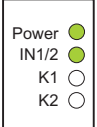
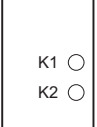
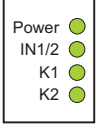
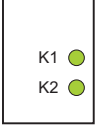
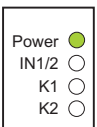
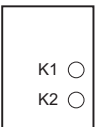

Figure 5-26 Application example: emergency stop monitoring with contact extension PSR-ESAM4/2x1/1x2 and PSR-URM4/5x1/2x2

## Application examples for conventional PSRclassic safety relays

## Function description

Start	Action	Result	Diagnostics, KS1	Diagnostics, KS2
	1. Unlock emergency stop button S1.	The emergency stop button closes enable circuit S11, S12 and S21, S22 of the safety relay. The circuit is enabled via the reset button.		
2. Press reset button S2.	Contact extension KS2 and contactors K3 ... K8 are activated. The mirror contacts (N/C contacts of KS2 and K3 ... K8) in the reset circuit are opened.			
Stop	Action	Result	Diagnostics	Diagnostics
	1. Press emergency stop button S1.	The safety function is triggered and contact extension KS2 as well as contactors K3 ... K8 drop out. In the reset circuit, the N/C contacts of KS2 and K3 ... K8 are closed.		

For additional diagnostic descriptions, please refer to Section 8.

## Notes on the application example

1. The emergency stop control device is positive opening in accordance with EN 60947-5-1.
2. Contactors K3 to K8 have mirror contacts in accordance with EN 60947-4-1.
3. Stop category 0 describes an immediate stop by removal of power by interrupting a machine or drive element in accordance with EN 60204-1.
4. The system behavior for category 4 permits that if a single fault occurs, the safety function is always executed and the single fault is detected on or before the next demand of the safety function.
5. Install the safety relay with the contact extension in an installation space in accordance with EN 60204-1 (e.g., in the control cabinet). This prevents a cross-circuit at the output of the safety relay.
6. When using the safety relay, take into consideration the maximum permissible number of cycles for observing the SIL/PL safety characteristics in the specific application. The safety characteristics can be found in the AH EN SAFETY CHARACTERISTICS application note or the SISTEMA library.

Application manual for PSRclassic and PSRmultifunction, and the modular safety relay system

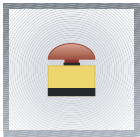

5.6.2 PSR-URM4/4NO/2NC up to PL e/SIL 3

Two-channel emergency stop monitoring with contact extension and manual reset (with cross-circuit detection)

<b>Order No.</b>	2702924 with screw connection 2702925 with spring-cage connection
<b>Technical data</b>	<ul style="list-style-type: none"> <li>- 24 V AC/DC</li> <li>- 4 enabling current paths, 1 signaling current path, and 1 confirmation current path</li> <li>- Basic insulation</li> <li>- Cat. 4, PL e in accordance with EN ISO 13849-1, SILCL 3 in accordance with EN 62061</li> </ul>

Application example

- Two-channel emergency stop monitoring with contact extension
- Cross-circuit detection
- Manual reset (S12, S34) at safety relay KS1
- Feedback of contactor contacts K3 ... K8 and KS2 at S34 at safety relay KS1
- Stop category 0
- Monitoring of external contactors
- Safety level of the example up to PL e (EN ISO 13849-1) and SIL 3 (EN 62061)

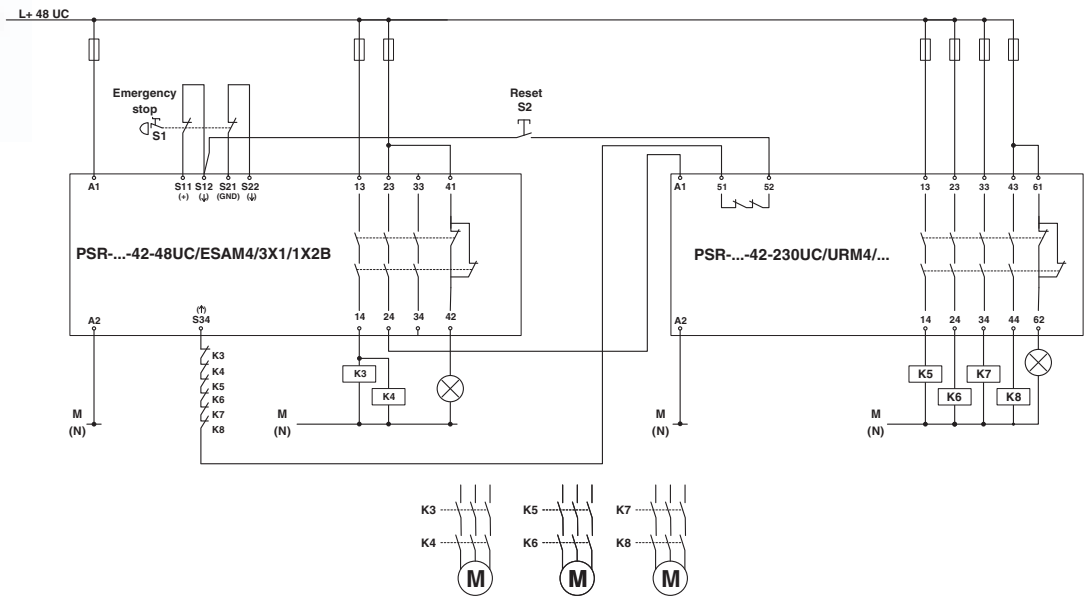

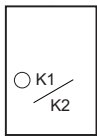

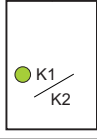

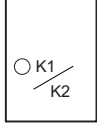

Figure 5-27 Application example: emergency stop monitoring with contact extension PSR-ESAM4/3x1/1x2/B and PSR-URM4/4NO/2NC

## Application examples for conventional PSRclassic safety relays

## Function description

Start	Action	Result	Diagnostics, KS1	Diagnostics, KS2
	1. Unlock emergency stop button S1.	The emergency stop button closes enable circuit S11, S12 and S21, S22 of the safety relay. The circuit is enabled via the reset button.		
2. Press reset button S2.	Contact extension KS2 and contactors K3 ... K8 are activated. The mirror contacts (N/C contacts of KS2 and K3 ... K8) in the reset circuit are opened.			
Stop	Action	Result	Diagnostics	Diagnostics
	1. Press emergency stop button S1.	The safety function is triggered and contact extension KS2 as well as contactors K3 ... K8 drop out. In the reset circuit, the N/C contacts of KS2 and K3 ... K8 are closed.		

For additional diagnostic descriptions, please refer to Section 8.

## Notes on the application example

1. The emergency stop control device is positive opening in accordance with EN 60947-5-1.
2. Contactors K3 to K8 have mirror contacts in accordance with EN 60947-4-1.
3. Stop category 0 describes an immediate stop by removal of power by interrupting a machine or drive element in accordance with EN 60204-1.
4. The system behavior for category 4 permits that if a single fault occurs, the safety function is always executed and the single fault is detected on or before the next demand of the safety function.
5. Install the safety relay with the contact extension in an installation space in accordance with EN 60204-1 (e.g., in the control cabinet). This prevents a cross-circuit at the output of the safety relay.
6. When using the safety relay, take into consideration the maximum permissible number of cycles for observing the SIL/PL safety characteristics in the specific application. The safety characteristics can be found in the AH EN SAFETY CHARACTERISTICS application note or the SISTEMA library.

Application manual for PSRclassic and PSRmultifunction, and the modular safety relay system

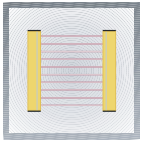

5.6.3 PSR-URML4/3x1/1x2/B up to PL e/SIL 3

Two-channel light grid monitoring (ESPE type 4)

<b>Order No.</b>	2903583 with screw connection 2903584 with spring-cage connection
<b>Technical data</b>	<ul style="list-style-type: none"> <li>- 24 V AC/DC</li> <li>- 3 enabling current paths, 1 signaling current path</li> <li>- Basic insulation</li> <li>- Cat. 4, PL e in accordance with EN ISO 13849-1, SILCL 3 in accordance with EN 62061</li> </ul>

Application example



- Two-channel light grid monitoring
- Cross-circuit detection via light grid
- Feedback of contactor contacts K3 and K4
- Stop category 0
- Monitoring of external contactors
- Safety level of the example up to PL e (EN ISO 13849-1) and SIL 3 (EN 62061)

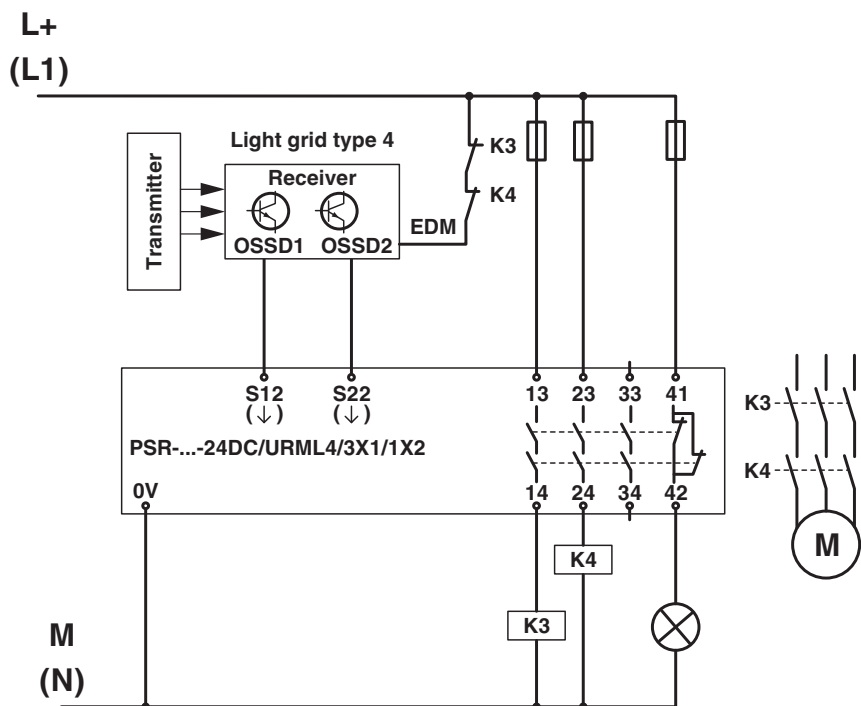
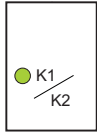
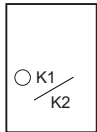

Figure 5-28 Application example: light grid monitoring PSR-URML4/3x1/1x2/B

## Application examples for conventional PSRclassic safety relays

### Function description

Start	Action	Result	Diagnostics
	1. The light grid is active, there is no object in the protective field.	Both OSSD signals from the light grid provide HIGH signals for enable circuit S12 and S22 of the safety relay.	
Stop	Action	Result	Diagnostics
	1. The light grid is interrupted, there is an object in the protective field.	The safety function is triggered by the interruption of the light grid and contactors K3 and K4 drop out.	

For additional diagnostic descriptions, please refer to Section 8.

### Notes on the application example

1. The light grid (ESPE) must meet type 4 requirements of standard EN 61496-1.
2. Make sure that the signal generator (e.g., light grid) and the safety relay have the same ground potential.
3. Contactors K3 to K8 have mirror contacts in accordance with EN 60947-4-1.
4. Stop category 0 describes an immediate stop by removal of power by interrupting a machine or drive element in accordance with EN 60204-1.
5. When using the safety relay, take into consideration the maximum permissible number of cycles for observing the SIL/PL safety characteristics in the specific application. The safety characteristics can be found in the AH EN SAFETY CHARACTERISTICS application note or the SISTEMA library.

**Application manual for PSRclassic and PSRmultifunction, and the modular safety relay system**

---

## 6 Application examples for multifunctional PSRmultifunction safety relays

### Three safety functions in one device

The multifunctional PSR-MXF safety relay is optimized for smaller machine applications with up to three safety functions.

Three different terminal block versions

The product range comprises four different special function modules, with three terminal block versions each (screw connection, spring-cage connection, Push-in connection).

### Higher-level sensor circuit

Different protection areas can be implemented in one machine, thanks to two local sensor circuits. Furthermore, the module has a higher-level sensor circuit, which simultaneously switches off both protective circuits on demand and can be used for emergency stop applications, for example.

Depending on the version, all standard sensors can be connected, such as safety door locking, light grids, and magnetic switches up to PL e in accordance with EN ISO 13849-1 and SILCL 3 in accordance with EN 62061.

### Overview of the multifunctional MXF safety relay:

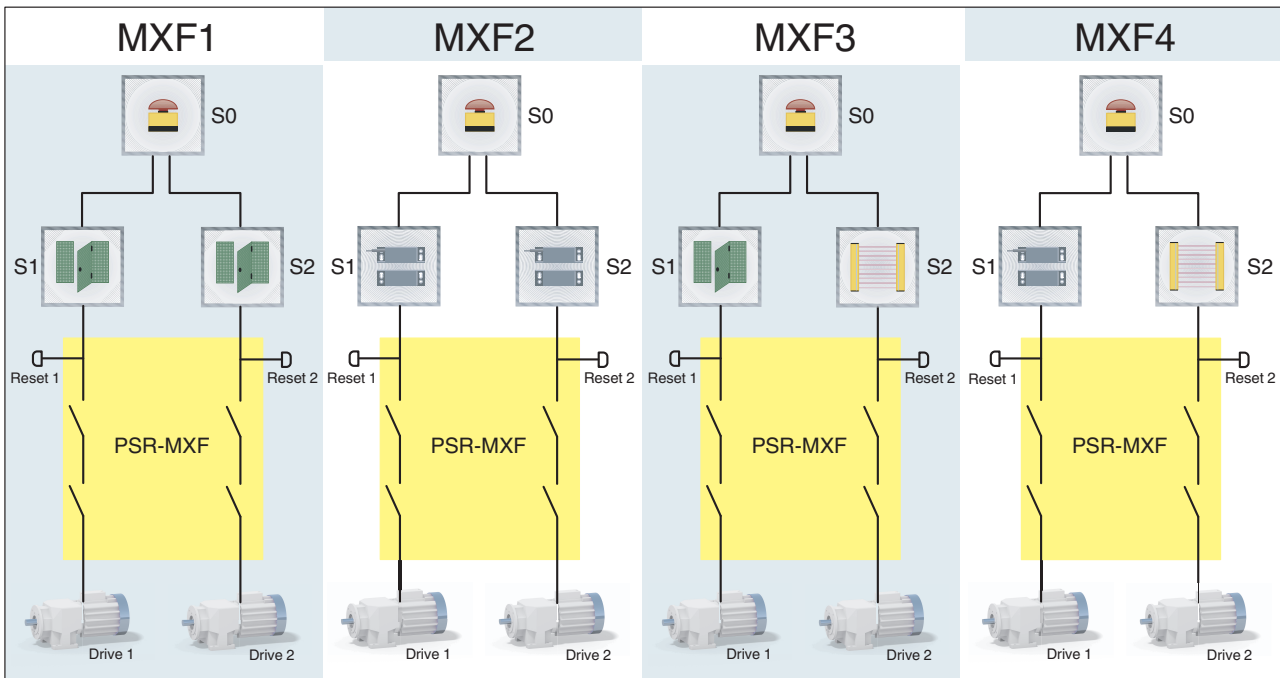
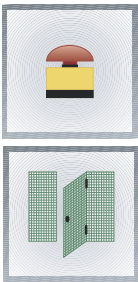

Figure 6-1 Overview of multifunctional safety relay

## 6.1 Multifunctional safety applications with emergency stop, safety doors, and light grids

### 6.1.1 PSR-MXF1/4X1/2X2/B up to PL e/SIL 3

Two-channel safety door monitoring with manual reset and higher-level emergency stop monitoring



<b>Order No.</b>	2902725 with screw connection 2902726 with spring-cage connection 2903253 with Push-in connection
<b>Technical data</b>	<ul style="list-style-type: none"> <li>- 24 V AC/DC</li> <li>- 4 enabling current paths, 2 signaling current paths</li> <li>- Monitored manual start or autostart</li> <li>- Basic insulation</li> <li>- Cat. 4, PL e in accordance with EN ISO 13849-1, SILCL 3 in accordance with EN 62061</li> </ul>

#### Application example

- Two-channel emergency stop and safety door monitoring
- Cross-circuit detection via S11, S21
- Manual start (S34, S36)
- Feedback of contactor contacts K5 and K6 at S34
- Feedback of contactor contacts K7 and K8 at S36
- Stop category 0
- Safety level of the example up to PL e (EN ISO 13849-1) and SIL 3 (EN 62061)

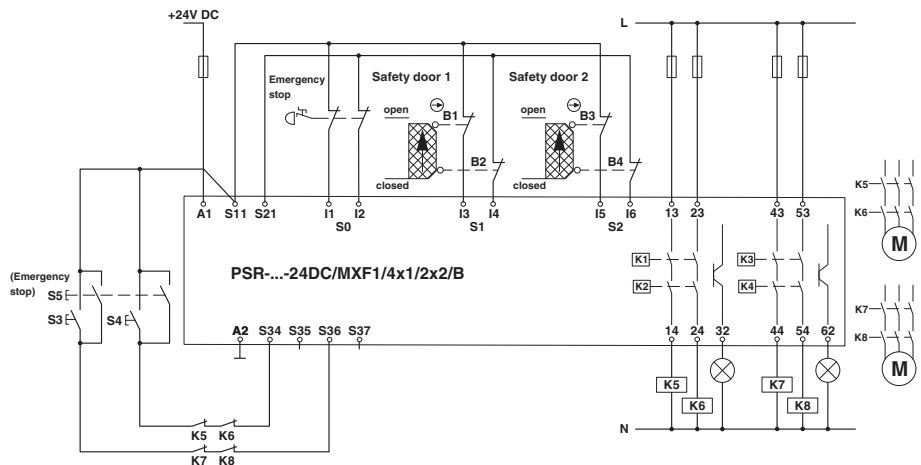
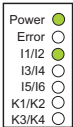
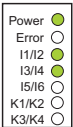
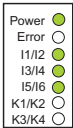

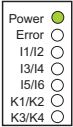
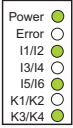
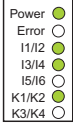

Figure 6-2 Two-channel emergency stop and safety door monitoring  
PSP-MXF1/4X1/2X2/B

Application examples for multifunctional PSR multifunction safety relays

Function description

Start	Action	Result	Diagnostics
	1. Unlock the emergency stop button.	The emergency stop button closes enable circuits S11, I1, and S21, I2 of the safety relay. The circuits are enabled via the reset button.	
	2. Close safety door 1.	The safety door circuit closes enable circuits S11, I3, and S21, I4 of the safety relay. The circuits are enabled via the reset buttons.	
	3. Close safety door 2.	The safety door circuit closes enable circuits S11, I5, and S21, I6 of the safety relay. The circuits are enabled via the reset buttons.	
	4. Press the reset buttons (S3 and S4).	Contactors K5, K6 and K7, K8 are activated and the mirror contacts (N/C contacts of K5, K6 and K7, K8) in the reset circuits are opened.	
Stop 1	Action	Result	Diagnostics
	1. Press the emergency stop button.	The safety function is triggered and contactors K5 ... K8 drop out. In the reset circuits, the mirror contacts of K5 ... K8 are closed.	
Stop 2 (alternatively)	Action	Result	Diagnostics
	1. Open safety door 1.	The safety function is triggered and contactors K5 and K6 drop out. In the reset circuit, the mirror contacts of K5 and K6 are closed.	
Stop 3 (alternatively)	Action	Result	Diagnostics
	1. Open safety door 2.	The safety function is triggered and contactors K7 and K8 drop out. In the reset circuit, the mirror contacts of K7 and K8 are closed.	



For additional diagnostic descriptions, please refer to the user documentation for the product. It can be downloaded at:  
[phoenixcontact.net/products](http://phoenixcontact.net/products).

## Application manual for PSRclassic and PSRmultifunction, and the modular safety relay system

---



### Notes on the application example

1. The emergency stop control device is positive opening in accordance with EN 60947-5-1.
2. The position switch is positive opening in accordance with EN 60947-5-1.
3. Contactors K5 ... K8 have mirror contacts in accordance with EN 60947-4-1.
4. Stop category 0 describes an immediate stop by removal of power by interrupting a machine or drive element in accordance with EN 60204-1.
5. When using the safety relay, take into consideration the maximum permissible number of cycles for observing the SIL/PL safety characteristics in the specific application. The safety characteristics can be found in the AH EN SAFETY CHARACTERISTICS application note or the SISTEMA library.

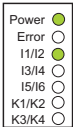
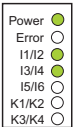
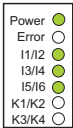

**Application manual for PSRclassic and PSRmultifunction, and the modular safety relay system**

**Function description**

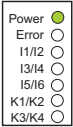
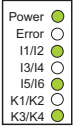
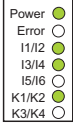
Start	Action	Result	Diagnostics
Start	1. Unlock the emergency stop button.	The emergency stop button closes enable circuits S11, I1, and S21, I2 of the safety relay.  The circuits are enabled via the reset button.	
	2. Close safety door 1 (S1).	The safety door circuit closes enable circuit S11, I3 and opens enable circuit S11, I4 of the safety relay.  The circuits are enabled via the reset buttons.	
	3. Close safety door 2 (S2).	The safety door circuit closes enable circuit S11, I5 and opens enable circuit S21, I6 of the safety relay.  The circuits are enabled via the reset buttons.	
	4. Press the reset buttons (S3 and S4).	Contactors K5, K6 and K7, K8 are activated and the mirror contacts (N/C contacts of K5, K6 and K7, K8) in the reset circuits are opened.	
Stop 1	Action	Result	Diagnostics
Stop 2 (alternatively)	1. Press the emergency stop button.	The safety function is triggered and contactors K5 ... K8 drop out.  In the reset circuits, the mirror contacts of K5 ... K8 are closed.	
	1. Open safety door 1 (S1).	The safety function is triggered and contactors K5 and K6 drop out.  In the reset circuit, the mirror contacts of K5 and K6 are closed.	
Stop 3 (alternatively)	Action	Result	Diagnostics
Stop 3 (alternatively)	1. Open safety door 2 (S2).	The safety function is triggered and contactors K7 and K8 drop out.  In the reset circuit, the mirror contacts of K7 and K8 are closed.	



For additional diagnostic descriptions, please refer to the user documentation for the product. It can be downloaded at:  
[phoenixcontact.net/products](http://phoenixcontact.net/products).

---

**Application examples for multifunctional PSR multifunction safety relays**

---

**Notes on the application example**

1. The emergency stop control device is positive opening in accordance with EN 60947-5-1.
2. The magnetic safety switch must meet the requirements of EN 60947-5-3.
3. Contactors K5 ... K8 have mirror contacts in accordance with EN 60947-4-1.
4. Stop category 0 describes an immediate stop by removal of power by interrupting a machine or drive element in accordance with EN 60204-1.
5. When using the safety relay, take into consideration the maximum permissible number of cycles for observing the SIL/PL safety characteristics in the specific application. The safety characteristics can be found in the AH EN SAFETY CHARACTERISTICS application note or the SISTEMA library.

Application manual for PSRclassic and PSRmultifunction, and the modular safety relay system

6.1.3 PSR-MXF3/4X1/2X2/B up to PL e/SIL 3

Two-channel safety door and light grid monitoring with manual reset (ESPE type 4) and higher-level emergency stop monitoring

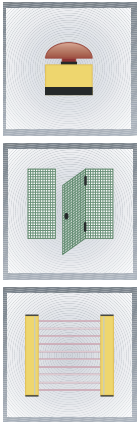

<b>Order No.</b>	2903257 with screw connection 2903258 with spring-cage connection 2903259 with Push-in connection
<b>Technical data</b>	<ul style="list-style-type: none"> <li>- 24 V AC/DC</li> <li>- 4 enabling current paths, 2 signaling current paths</li> <li>- Monitored manual start or autostart</li> <li>- Basic insulation</li> <li>- Cat. 4, PL e in accordance with EN ISO 13849-1, SILCL 3 in accordance with EN 62061</li> </ul>

Application example



- Two-channel emergency stop, safety door, and light grid monitoring
- Cross-circuit detection for emergency stop and safety door via S11, S21
- Manual start (S34, S36)
- Feedback of contactor contacts K5 and K6 at S34
- Feedback of contactor contacts K7 and K8 at S36
- Stop category 0
- Safety level of the example up to PL e (EN ISO 13849-1) and SIL 3 (EN 62061)

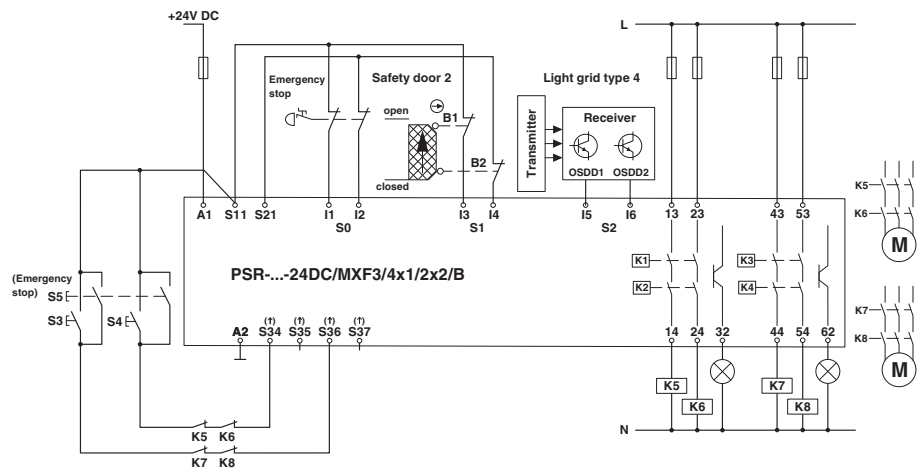
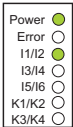
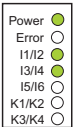
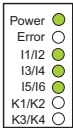

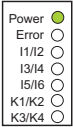
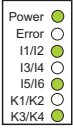
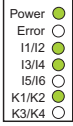

Figure 6-4 Two-channel emergency stop, safety door, and light grid monitoring PSP-MXF3/4X1/2X2/B

Application examples for multifunctional PSR multifunction safety relays

Function description

Start	Action	Result	Diagnostics
	1. Unlock the emergency stop button.	The emergency stop button closes enable circuits S11, I1, and S21, I2 of the safety relay.  The circuits are enabled via the reset button.	
	2. Close the safety door.	The safety door circuit closes enable circuits S11, I3, and S21, I4 of the safety relay.  The circuits are enabled via the reset buttons.	
	3. The light grid is active, there is no object in the protective field.	Both OSSD signals from the light grid provide HIGH signals to enable circuits S11, I5 and S21, I6 of the safety relay.  The circuits are enabled via the reset buttons.	
	4. Press the reset buttons (S3 and S4).	Contactors K5, K6 and K7, K8 are activated and the mirror contacts (N/C contacts of K5, K6 and K7, K8) in the reset circuits are opened.	
Stop 1	Action	Result	Diagnostics
	1. Press the emergency stop button.	The safety function is triggered and contactors K5 ... K8 drop out. In the reset circuits, the mirror contacts of K5 ... K8 are closed.	
Stop 2 (alternatively)	Action	Result	Diagnostics
	1. Open the safety door.	The safety function is triggered and contactors K5 and K6 drop out. In the reset circuit, the mirror contacts of K5 and K6 are closed.	
Stop 3 (alternatively)	Action	Result	Diagnostics
	1. The light grid is interrupted, there is an object in the protective field.	The safety function is triggered by the interruption of the light grid and contactors K7 and K8 drop out. In the reset circuit, the mirror contacts of K7 and K8 are closed.	



For additional diagnostic descriptions, please refer to the user documentation for the product. It can be downloaded at:  
[phoenixcontact.net/products](http://phoenixcontact.net/products).

## Application manual for PSRclassic and PSRmultifunction, and the modular safety relay system

---

### Notes on the application example

1. The emergency stop control device is positive opening in accordance with EN 60947-5-1.
2. The position switch is positive opening in accordance with EN 60947-5-1.
3. The light grid (ESPE) must meet type 4 requirements of standard EN 61496-1.
4. Make sure that the signal generator (e.g., light grid) and the safety relay have the same ground potential.
5. Contactors K5 ... K8 have mirror contacts in accordance with EN 60947-4-1.
6. Stop category 0 describes an immediate stop by removal of power by interrupting a machine or drive element in accordance with EN 60204-1.
7. When using the safety relay, take into consideration the maximum permissible number of cycles for observing the SIL/PL safety characteristics in the specific application. The safety characteristics can be found in the AH EN SAFETY CHARACTERISTICS application note or the SISTEMA library.

Application examples for multifunctional PSRmultifunction safety relays

6.1.4 PSR-MXF4/4X1/2X2/B up to PL e/SIL 3

Two-channel safety door (non-equivalent) and light grid monitoring with manual reset (ESPE type 4) and higher-level emergency stop monitoring

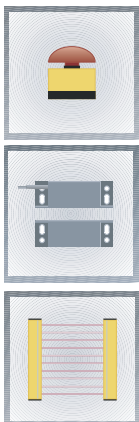

<b>Order No.</b>	2903260 with screw connection 2903261 with spring-cage connection 2903262 with Push-in connection
<b>Technical data</b>	<ul style="list-style-type: none"> <li>- 24 V AC/DC</li> <li>- 4 enabling current paths, 2 signaling current paths</li> <li>- Monitored manual start or autostart</li> <li>- Basic insulation</li> <li>- Cat. 4, PL e in accordance with EN ISO 13849-1, SILCL 3 in accordance with EN 62061</li> </ul>

Application example

- Two-channel emergency stop, safety door, and light grid monitoring
- Manual start (S34, S36)
- Feedback of contactor contacts K5 and K6 at S34
- Feedback of contactor contacts K7 and K8 at S36
- Stop category 0
- Safety level of the example up to PL e (EN ISO 13849-1) and SIL 3 (EN 62061)

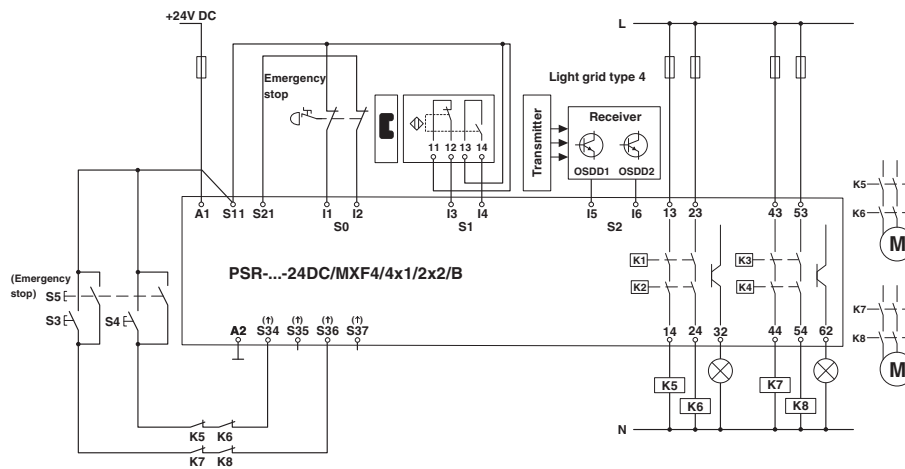
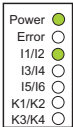
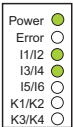
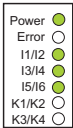

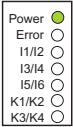
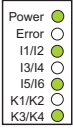
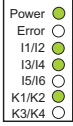

Figure 6-5 Two-channel emergency stop, safety door, and light grid monitoring PSP-MXF4/4X1/2X2/B

**Application manual for PSRclassic and PSRmultifunction, and the modular safety relay system**

**Function description**

Start	Action	Result	Diagnostics
	1. Unlock the emergency stop button.	The emergency stop button closes enable circuits S11, I1, and S21, I2 of the safety relay.  The circuits are enabled via the reset button.	
	2. Close the safety door.	The safety door circuit closes enable circuit S11, I3 and opens enable circuit S21, I4 of the safety relay.  The circuits are enabled via the reset buttons.	
	3. The light grid is active, there is no object in the protective field.	Both OSSD signals from the light grid provide HIGH signals to enable circuits S11, I5 and S21, I6 of the safety relay.  The circuits are enabled via the reset buttons.	
	4. Press the reset buttons (S3 and S4).	Contactors K5, K6 and K7, K8 are activated and the mirror contacts (N/C contacts of K1, K2 and K3, K4) in the reset circuits are opened.	
Stop 1	Action	Result	Diagnostics
	1. Press the emergency stop button.	The safety function is triggered and contactors K5 ... K8 drop out. In the reset circuits, the mirror contacts of K5 ... K8 are closed.	
Stop 2 (alternatively)	Action	Result	Diagnostics
	1. Open the safety door.	The safety function is triggered and contactors K5 and K6 drop out. In the reset circuit, the mirror contacts of K5 and K6 are closed.	
Stop 3 (alternatively)	Action	Result	Diagnostics
	1. The light grid is interrupted, there is an object in the protective field.	The safety function is triggered by the interruption of the light grid and contactors K7 and K8 drop out. In the reset circuit, the mirror contacts of K7 and K8 are closed.	



For additional diagnostic descriptions, please refer to the user documentation for the product. It can be downloaded at:  
[phoenixcontact.net/products](http://phoenixcontact.net/products).

---

**Application examples for multifunctional PSR multifunction safety relays**

---

**Notes on the application example**

1. The emergency stop control device is positive opening in accordance with EN 60947-5-1.
2. The position switch is positive opening in accordance with EN 60947-5-1.
3. The light grid (ESPE) must meet type 4 requirements of standard EN 61496-1.
4. Make sure that the signal generator (e.g., light grid) and the safety relay have the same ground potential.
5. Contactors K5 ... K8 have mirror contacts in accordance with EN 60947-4-1.
6. Stop category 0 describes an immediate stop by removal of power by interrupting a machine or drive element in accordance with EN 60204-1.
7. When using the safety relay, take into consideration the maximum permissible number of cycles for observing the SIL/PL safety characteristics in the specific application. The safety characteristics can be found in the AH EN SAFETY CHARACTERISTICS application note or the SISTEMA library.

**Application manual for PSRclassic and PSRmultifunction, and the modular safety relay system**

---

## 7 Application examples using the modular safety relay system

### 7.1 PSR-SDC4/2x1/B master module

#### Automatic operating mode detection

The intelligent master safety relay automatically identifies the desired operating mode via the sensor connections. This means that switches do not have to be set on the device.

The clearly arranged design of the modular safety relays helps you to quickly localize errors in your safety circuits.

#### Your advantages:

- Fast installation
- Error-free startup
- Easy error localization



Figure 7-1 PSR-SDC4/2x1/B master module

#### Safe cross-wiring with PSR-TBUS

PSR-TBUS DIN rail connectors help establish a robust and safe connection between the master module and extension modules. This renders the usual cross-wiring for the supply voltage, the enable signal, and the confirmation current path redundant.

#### Fast system extension

Up to ten safety relays can be easily connected to a PSR-TBUS DIN rail connector to create a safety system with 42 contacts.

Application manual for PSRclassic and PSRmultifunction, and the modular safety relay system

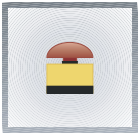

7.1.1 PSR-SDC4/2x1/B up to PL e/SIL 3

Two-channel emergency stop monitoring with manual reset (with cross-circuit detection)

<b>Order No.</b>	2981486 with screw connection 2981499 with spring-cage connection
<b>Technical data</b>	<ul style="list-style-type: none"> <li>- 24 V AC/DC</li> <li>- 2 enabling current paths, 1 semiconductor signaling current path</li> <li>- Monitored manual start or autostart</li> <li>- Basic insulation</li> <li>- Cat. 4/PL e in accordance with EN ISO 13849-1, SILCL 3 in accordance with EN 62061</li> </ul>

Application example



- Two-channel emergency stop monitoring
- Cross-circuit detection
- Ground fault detection (S11, S12 only)
- Manual reset (S33, S34)
- Feedback of contactor contacts K3 and K4 at S33 and S34
- Stop category 0
- Monitoring of external contactors
- Safety level of the example up to PL e (EN ISO 13849-1) and SIL 3 (EN 62061)

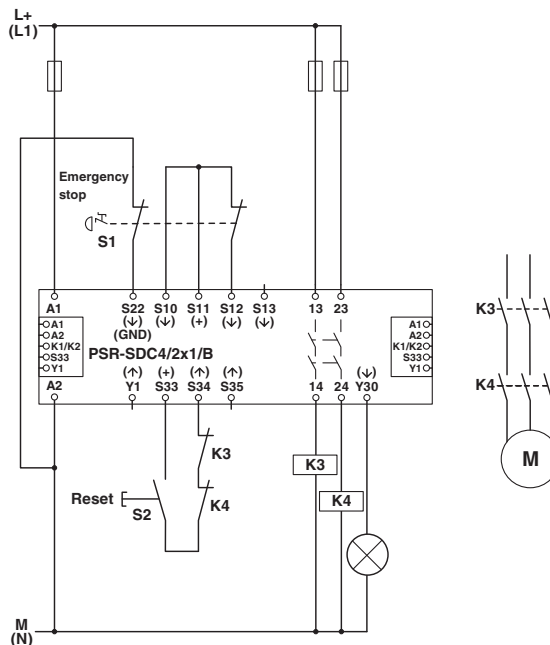
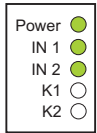
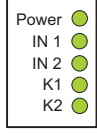
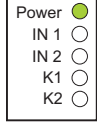

Figure 7-2 Two-channel emergency stop monitoring with manual reset PSR-SDC4/2x1/B

## Application examples using the modular safety relay system

### Function description

Start	Action	Result	Diagnostics
	1. Unlock emergency stop button S1.	The emergency stop button closes the first enable circuit via S10, S11, and S12 and the second enable circuit via A2 and S22 of the safety relay.  The circuits are enabled via the reset button.	
	2. Press reset button S2.	Contactors K3 and K4 are activated and the mirror contacts (N/C contacts of K3 and K4) in the reset circuit are opened.	
Stop	Action	Result	Diagnostics
	1. Press emergency stop button S1.	The safety function is triggered and contactors K3 and K4 drop out. In the reset circuit, the mirror contacts of K3 and K4 are closed.	

For additional diagnostic descriptions, please refer to Section 8.

### Notes on the application example

1. The emergency stop control device is positive opening in accordance with EN 60947-5-1.
2. Contactors K3 and K4 have mirror contacts in accordance with EN 60947-4-1.
3. When using the safety relay, take into consideration the maximum permissible number of cycles for observing the SIL/PL safety characteristics in the specific application. The safety characteristics can be found in the AH EN SAFETY CHARACTERISTICS application note or the SISTEMA library.

Application manual for PSRclassic and PSRmultifunction, and the modular safety relay system

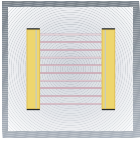

7.1.2 PSR-SDC4/2x1/B up to PL e/SIL 3

Two-channel light grid monitoring with manual reset (ESPE type 4)

<b>Order No.</b>	2981486 with screw connection 2981499 with spring-cage connection
<b>Technical data</b>	<ul style="list-style-type: none"> <li>- 24 V AC/DC</li> <li>- 2 enabling current paths, 1 semiconductor signaling current path</li> <li>- Manual start or autostart</li> <li>- Basic insulation</li> <li>- Cat. 4/PL e in accordance with EN ISO 13849-1, SILCL 3 in accordance with EN 62061</li> </ul>

Application example

- Two-channel light grid monitoring
- Manual reset (S33, S34)
- Feedback of contactor contacts K3 and K4 at S33 and S34
- Stop category 0
- Monitoring of external contactors
- Safety level of the example up to PL e (EN ISO 13849-1) and SIL 3 (EN 62061)

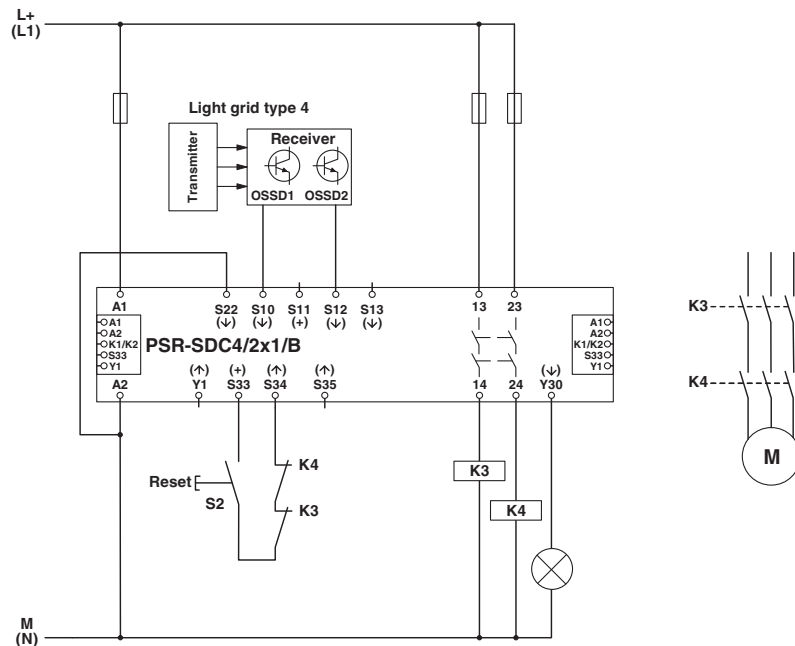
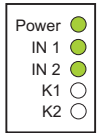
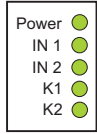
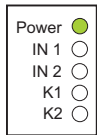

Figure 7-3 Two-channel light grid monitoring with manual reset PSR-SDC4/2x1/B

## Application examples using the modular safety relay system

### Function description

Start	Action	Result	Diagnostics
	1. The light grid is active, there is no object in the protective field.	Both OSSD signals from the light grid provide HIGH signals to enable circuit S10–S12 of the safety relay.	
	2. Press reset button S2.	Contactors K3 and K4 are activated and the mirror contacts (N/C contacts of K3 and K4) in the reset circuit are opened.	
Stop	Action	Result	Diagnostics
	1. The light grid is interrupted, there is an object in the protective field.	The safety function is triggered by the interruption of the light grid and contactors K3 and K4 drop out. In the reset circuit, the mirror contacts of K3 and K4 are closed.	

For additional diagnostic descriptions, please refer to Section 8.

### Notes on the application example

1. The light grid (ESPE) must meet type 4 requirements of standard EN 61496-1.
2. Make sure that the signal generator (e.g., light grid) and the safety relay have the same ground potential.
3. Contactors K3 and K4 have mirror contacts in accordance with EN 60947-4-1.
4. Stop category 0 describes an immediate stop by removal of power by interrupting a machine or drive element in accordance with EN 60204-1.
5. The system behavior for category 4 permits that if a single fault occurs, the safety function is always executed and the single fault is detected on or before the next demand of the safety function.
6. The advantage of category 4 compared to category 3 is that an accumulation of undetected faults does not lead to the loss of the safety function.
7. When using the safety relay, take into consideration the maximum permissible number of cycles for observing the SIL/PL safety characteristics in the specific application. The safety characteristics can be found in the AH EN SAFETY CHARACTERISTICS application note or the SISTEMA library.

Application manual for PSRclassic and PSRmultifunction, and the modular safety relay system

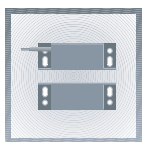

### 7.1.3 PSR-SDC4/2x1/B up to PL e/SIL 3

#### Two-channel, non-equivalent safety door monitoring with manual reset

<b>Order No.</b>	2981486 with screw connection 2981499 with spring-cage connection
<b>Technical data</b>	<ul style="list-style-type: none"> <li>- 24 V AC/DC</li> <li>- 2 enabling current paths, 1 semiconductor signaling current path</li> <li>- Monitored manual start or autostart</li> <li>- Basic insulation</li> <li>- Cat. 4/PL e in accordance with EN ISO 13849-1, SILCL 3 in accordance with EN 62061</li> </ul>

#### Application example



- Two-channel, non-equivalent safety door monitoring with one magnetic safety switch
- Ground fault detection
- Manual reset (S33, S34)
- Feedback of contactor contacts K3 and K4 at S33 and S34
- Stop category 0
- Monitoring of external contactors
- Safety level of the example up to PL e (EN ISO 13849-1) and SIL 3 (EN 62061)

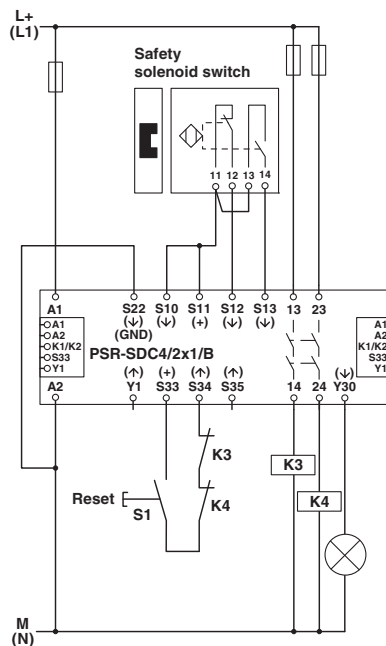
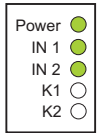
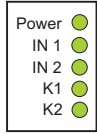
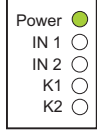

Figure 7-4 Two-channel safety door monitoring with manual reset PSR-SDC4/2x1/B

## Application examples using the modular safety relay system

### Function description

Start	Action	Result	Diagnostics
	1. Close the safety door.	The safety door circuit closes the first enable circuit via S10, S11, and S12 and opens the second enable circuit via S10, S11, and S13 of the safety relay.  The circuits are enabled via the reset button.	
	2. Press reset button S1.	Contactors K3 and K4 are activated and the mirror contacts (N/C contacts of K3 and K4) in the reset circuit are opened.	
Stop	Action	Result	Diagnostics
	1. Open the safety door.	The safety function is triggered and contactors K3 and K4 drop out.  In the reset circuit, the mirror contacts of K3 and K4 are closed.	

For additional diagnostic descriptions, please refer to Section 8.

### Notes on the application example

1. The magnetic safety switch must meet the requirements of EN 60947-5-3.
2. Contactors K3 and K4 have mirror contacts in accordance with EN 60947-4-1.
3. When using the safety relay, take into consideration the maximum permissible number of cycles for observing the SIL/PL safety characteristics in the specific application. The safety characteristics can be found in the AH EN SAFETY CHARACTERISTICS application note or the SISTEMA library.

## Application manual for PSRclassic and PSRmultifunction, and the modular safety relay system

---

## 7.2 Contact extension/force-guided contacts

Often more contacts are required than are available as standard. For these applications, the force-guided contact extension modules are used. They can be activated module-by-module, if required.

### Forced guidance

Standard EN 50205 makes a distinction between two groups of relays with force-guided contacts:

- Application type A: relay with a set of force-guided contacts
- Application type B: relay with a set of force-guided contacts and other contacts which are not force-guided, as well as a set of contacts with changeover contacts

The definition of “forced guidance” in accordance with EN 50205 is:

The relay must be designed so that none of the mechanically connected N/C contacts can close if an N/O contact is closed and that none of the mechanically connected N/O contacts can close if an N/C contact is closed.

These requirements apply for the entire service life of the relay and for reasonably foreseeable failure conditions.

The effects of reasonably foreseeable breaks and/or wear on parts of the elementary relay must not cause the (mechanical) forced guidance to fail.

During the entire relay service life specified by the manufacturer, the contact distances of opened contacts must be greater than 0.5 mm for a single N/C contact and greater than 0.3 mm each for a double interrupt. (Mechanical) forced guidance of contacts means that none of the N/C contacts may close if an N/O contact does not open for the non-activated relay. In addition, none of the N/O contacts may close if an N/C contact does not open when the relay is activated.

Application manual for PSRclassic and PSRmultifunction, and the modular safety relay system

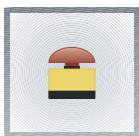

### 7.2.1 PSR-URM4/4x1/2x2/B up to PL e/SIL 3

Two-channel emergency stop monitoring with contact extension and manual reset (with cross-circuit detection)

<b>Order No.</b>	2981677 with screw connection 2981680 with spring-cage connection
<b>Technical data</b>	<ul style="list-style-type: none"> <li>- 24 V AC/DC</li> <li>- 4 enabling current paths, 1 signaling current path, and 1 signal contact</li> <li>- Basic insulation</li> <li>- Cat. 4/PL e in accordance with EN ISO 13849-1, SILCL 3 in accordance with EN 62061</li> </ul>

Application example



- Two-channel emergency stop monitoring with contact extension
- Cross-circuit detection
- Ground fault detection (S11, S12 only)
- Manual reset (S33, S34)
- Feedback of contactor contacts K3 ... K6 at S33 and S34
- Stop category 0
- Monitoring of external contactors
- Safety level of the example up to PL e (EN ISO 13849-1) and SIL 3 (EN 62061)

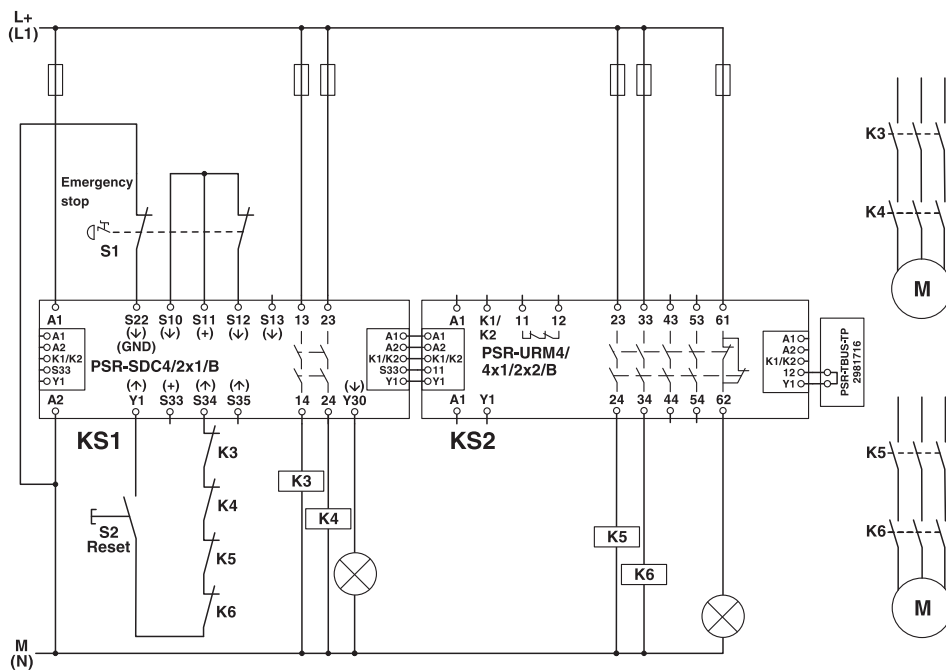

Figure 7-5 Two-channel emergency stop monitoring with contact extension and manual reset  
PSR-SDC4/2x1/B and PSR-URM4/4x1/2x2/B

Application examples using the modular safety relay system

Function description

Start	Action	Result	Diagnostics, KS1	Diagnostics, KS2
	1. Unlock emergency stop button S1.	The emergency stop button closes the first enable circuit via S10, S11, and S12 and closes the second enable circuit via A2 and S22 of the safety relay.		
2. Press reset button S2.	Contactors K3 ... K6 are activated and the mirror contacts (N/C contacts of K3 ... K6) are opened in the reset circuit.			
Stop	Action	Result	Diagnostics	Diagnostics
	1. Press emergency stop button S1.	The safety function is triggered and contactors K3 ... K6 drop out.  In the reset circuit, the mirror contacts of K3 ... K6 are closed.		

For additional diagnostic descriptions, please refer to Section 8.

Notes on the application example

1. The emergency stop control device is positive opening in accordance with EN 60947-5-1.
2. Contactors K3, K4, K5, and K6 have mirror contacts in accordance with EN 60947-4-1.
3. Stop category 0 describes an immediate stop by removal of power by interrupting a machine or drive element in accordance with EN 60204-1.
4. When using the safety relay, take into consideration the maximum permissible number of cycles for observing the SIL/PL safety characteristics in the specific application. The safety characteristics can be found in the AH EN SAFETY CHARACTERISTICS application note or the SISTEMA library.

## Application manual for PSRclassic and PSRmultifunction, and the modular safety relay system

---

## 8 Diagnostic description

Meaning of the LED symbols in the tables below:

- LED is off
- LED is on
- ✱ LED flashing

The table is valid for the following safety relays:

- 1 PSR-ESL4/3x1/1x2/B
- 2 PSR-ESA2/4x1/1x2/B
- 3 PSR-ESAM2/3x1/1x2/B
- 4 PSR-ESAM4/3x1/1x2
- 5 PSR-ESAM4/8x1/1x2
- 6 PSR-THC4/2x1/1x2

Table 8-1 Diagnostic description for PSR-ESL4/..., PSR-ESA2/..., PSR-ESAM2/..., PSR-ESAM4/... and PSR-THC4/... safety relays

	PWR	K1	K2		Fault	Remedy	Valid for
Connection/ voltage error	○	○	○		Supply voltage not present.	Apply supply voltage.	All
	●	○	●		Supply voltage too low.	Adjust supply voltage.	All
	●	○	○				
	●	○	○		The enable circuits are connected incorrectly or not connected at all.	Check the connection of the enable circuits.	All
	●	○	○		No bridge between Y1 and Y2.	Insert bridge.	6
Cross-circuit	●	○	●		Between both enable circuits S11-S12 and S11-S22. Error detection on next demand. E.g., for emergency stop or safety door.	Remove cross-circuit.	1
	●	●	○		Between both enable circuits S11-S22 and S11-S12. Error detection on next demand. E.g., for emergency stop or safety door.		1
	○	○	○		Between enable circuits S11-S12 and S21-S22.		4, 5

**Application manual for PSRclassic and PSRmultifunction, and the modular safety relay system**

Table 8-1 Diagnostic description for PSR-ESL4/..., PSR-ESA2/..., PSR-ESAM2/..., PSR-ESAM4/... and PSR-THC4/... safety relays

	PWR	K1	K2			Fault	Remedy	Valid for
Cross-circuit	●	○	○			Between both enable circuits S12 and S22. The fault is not detected by the module itself. E.g., for light grid type 4.	Remove cross-circuit.	1
	○	○	○			Between enable circuits S11-S14/S12 and S21-S24/S22.		6
Short circuit	○	○	○			Between contact points A1 and A2.	Remove short circuit.	All
	●	●	○			Between S11 and S12. Fault detection on next demand.		1, 4, 5
	●	○	●			Between S11 and S22. Fault detection on next demand.		1, 4, 5
	●	○	○			Between S11 and S12 or S11 and S14. Fault detection on next demand.		6
	●	○	○			Between S21 and S22 or S21 and S24. Fault detection on next demand.		6
Fault in reset circuit	●	○	●			Faulty reset button. Short circuit between S33 and S34. No fault detection on initial start, only on first new demand.	Remove short circuit.	1, 2, 3, 4, 5
Fault with internal cause	●	○	●			Enable contact(s) of K1 faulty.	Replace safety relays.	All
	●	●	○			Enable contact(s) of K2 faulty.		
	●	○	○			Enable contact(s) of K1 and K2 faulty.		

The table is valid for the following safety relays:

- 1 PSR-ESAM4/2x1/1x2
- 2 PSR-ESAM4/3x1/1x2/B
- 3 PSR-ESA4/2x1/1x2
- 4 PSR-ESA4/3x1/1x2/B

Table 8-2 Diagnostic description for PSR-ESAM4/... and PSR-ESA4/... safety relays

	PWR	IN1/2	K1	K2	Fault	Remedy	Valid for
Connection/ voltage error	○	○	○	○	Supply voltage not present.	Apply supply voltage.	All
	●	●	●	○	Supply voltage too low.	Adjust supply voltage.	1
	●	●	○	○			2
	●	●	○	●			3, 4, 5
●	○	○	○	The enable circuits are connected incorrectly or not connected at all.	Check the connection of the enable circuits.	1	
Cross-circuit	○	○	○	○	Between both enable circuits S11-S12 and S21-S22. E.g., for emergency stop.	Remove cross-circuit.	All
Short circuit	○	○	○	○	Between contact points A1 and A2.	Remove short circuit.	All
	●	●	●	○	Between S11 and S12. Fault detection on next demand.		All
	●	●	○	●	Between S21 and S22. Fault detection on next demand.		All
Fault in reset circuit	●	●	○	●	Faulty reset button, short circuit between S12 and S34.	Replace reset button. Remove short circuit.	1
	●	●	○	○	No fault detection on initial start, only on first new demand.	Replace reset button. Remove short circuit.	2
	●	●	○	●	Faulty reset button, short circuit between S33 and S34. No fault detection on initial start, only on first new demand.	Replace reset button. Remove short circuit.	5
Fault in reset circuit	●	●	○	●	Enable contact(s) of K1 faulty.	Replace safety relays.	All
	●	●	●	○	Enable contact(s) of K2 faulty.		
	●	●	○	○	Enable contact(s) of K1 and K2 faulty.		

## Application manual for PSRclassic and PSRmultifunction, and the modular safety relay system

The table is valid for the following safety relays:

- 1 PSR-ESD/5x1/1x2/300
- 2 PSR-ESD/5x1/1x2/T

Table 8-3 Diagnostic description for PSR-ESD/5x1/1x2/... safety relay

	PWR	K1	K2	K3(t)	K4(t)	Fault	Remedy	Valid for
Connection/ voltage error	<input type="radio"/>	<input type="radio"/>	<input type="radio"/>	<input type="radio"/>	<input type="radio"/>	Supply voltage not present.	Apply supply voltage.	All
	<input checked="" type="radio"/>	<input type="radio"/>	<input type="radio"/>	<input type="radio"/>	<input type="radio"/>	Supply voltage too low.	Adjust supply voltage.	
	<input checked="" type="radio"/>	<input type="radio"/>	<input type="radio"/>	<input type="radio"/>	<input type="radio"/>	The enable circuits are connected incorrectly or not connected at all.	Check the connection of the enable circuits.	
	<input checked="" type="radio"/>	<input type="radio"/>	<input type="radio"/>	<input type="radio"/>	<input type="radio"/>	No bridge between Y1 and Y2.	Insert bridge.	
	<input checked="" type="radio"/>	<input type="radio"/>	<input type="radio"/>	<input type="radio"/>	<input type="radio"/>	Missing bridge between S10 and S11. E.g., for two-channel emergency stop wiring.	Insert bridge.	
Cross-circuit	<input type="radio"/>	<input type="radio"/>	<input type="radio"/>	<input type="radio"/>	<input type="radio"/>	Between both enable circuits S10/S11-S12 and S21-S22. E.g., for emergency stop or safety door.	Remove cross-circuit.	
	<input checked="" type="radio"/>	<input type="radio"/>	<input type="radio"/>	<input type="radio"/>	<input type="radio"/>	Between both enable circuits S10 and S12. E.g., for light grid type 4.		
Short circuit	<input type="radio"/>	<input type="radio"/>	<input type="radio"/>	<input type="radio"/>	<input type="radio"/>	Between contact points A1 and A2.	Remove short circuit.	
	<input checked="" type="radio"/>	<input checked="" type="radio"/>	<input type="radio"/>	<input type="radio"/>	<input type="radio"/>	Between S11 and S12. Fault detection on next demand.		
	<input checked="" type="radio"/>	<input type="radio"/>	<input checked="" type="radio"/>	<input type="radio"/>	<input type="radio"/>	Between S21 and S22. Fault detection on next demand.		
Fault in reset circuit	<input checked="" type="radio"/>	<input type="radio"/>	<input checked="" type="radio"/>	<input type="radio"/>	<input type="radio"/>	Faulty reset button. Short circuit between S33 and S34. No fault detection on initial start, only on first new demand.	Remove short circuit.	
Fault with internal cause	<input checked="" type="radio"/>	<input type="radio"/>	<input checked="" type="radio"/>	<input checked="" type="radio"/>	<input checked="" type="radio"/>	Enable contact(s) of K1 faulty.	Replace safety relays.	All

The table is valid for the following safety relays:

1 PSR-ESD/4x1/30

Table 8-4 Diagnostic description for PSR-ESD/4x1/30 safety relay

	PWR	K1/K2	K3(t)/K4(t)			Fault	Remedy
Connection/ voltage error	○	○	○			Supply voltage not present.	Apply supply voltage.
	☀	○	○			Supply voltage too low.	Adjust supply voltage.
	☀ 1 s	○	○			Supply voltage too high.	Adjust supply voltage.
	☀	○	○			The enable circuits are connected incorrectly or not connected at all.	Check the connection of the enable circuits.
Cross-circuit	☀ 1 s	○	○			Between both enable circuits S11-S12 and S21-S22. E.g., for emergency stop or safety door.	Remove cross-circuit.
	☀	○	○			Between enable circuit S12-S22 for applications with light grid and safe PLC (see <a href="#">Section 5.2.2</a> ). Fault is detected and indicated by the light grid/PLC.	
Short circuit	○	○	○			Between contact points A1 and A2.	Remove short circuit.
	☀ 1 s	○	○			Between S11 and S12. Error detection on next demand.	
	☀ 1 s	○	○			Between S21 and S22. Fault detection on next demand.	
Fault in reset circuit	☀ 1 s	○	○			Faulty reset button. Short circuit between A1 and S34. No fault detection on initial start, only once all enable contacts have been opened.	Remove short circuit.
Configuration error	☀ 1 s	☀ 1 s	○			If a cross-circuit or overvoltage/under-voltage occurs during the configuration phase, the safety module indicates a configuration error.	Check the wiring and the operating voltage supply. Perform a voltage reset.
	☀ 1 s	☀ 1 s	☀ 1 s			Rotary switch (delay time) was modified.	Perform configuration again.

**Application manual for PSRclassic and PSRmultifunction, and the modular safety relay system**

Table 8-4 Diagnostic description for PSR-ESD/4x1/30 safety relay

	PWR	K1/K2	K3(t)/K4(t)			Fault	Remedy
Fault with internal cause	☀ 0.2 s	○	○			Safety relay faulty.	Replace safety relays. Perform a voltage reset.
	☀ 0.2 s	○	○			Enable contact(s) of K1 and K2 faulty.	
	☀ 0.2 s	○	○			Enable contact(s) of K3 and K4 faulty.	

The table is valid for the following safety relays:

- 1 PSR-URM4/5x1/2x2

Table 8-5 Diagnostic description for PSR-URM4/5x1/2x2 safety relay

	K1	K2				Fault	Remedy
Connection/ voltage error	○	○				Supply voltage not present.	Apply supply voltage.
	○	○				Supply voltage too low.	Adjust supply voltage.
	○	●				Input circuit A11 is not being supplied with power.	Check the input circuit connection
	●	○				Input circuit A12 is not being supplied with power.	
Short circuit	○	○				Between contact points A11 and A2 or between A12 and A2.	Remove short circuit.
Fault with internal cause	○	○				Checkback contacts 11 and 12 faulty.	Replace safety relays. Perform a voltage reset.
	○	●				Enable contact(s) of K1 faulty.	
	●	○				Enable contact(s) of K2 faulty.	
	○	○				Enable contact(s) of K1 and K2 faulty.	

The table is valid for the following safety relays:

- 1 PSR-URM4/5x1/2x2/B
- 2 PSR-URM4/4NO/2NC

Table 8-6 Diagnostic description for PSR-URM4/5x1/2x2/B and PSR-URM4/4NO/2NC safety relays

	K1/K2					Fault	Remedy	Valid for
Connection/ voltage error	<input type="radio"/>					Supply voltage not present.	Apply supply voltage.	All
	<input type="radio"/>					Supply voltage too low.	Adjust supply voltage.	
	<input type="radio"/>					The input circuit is connected incorrectly or not connected at all.	Check the input circuit connection	
Short circuit	<input type="radio"/>					Between contact points A1 and A2.	Remove short circuit.	
Fault with internal cause	<input type="radio"/>					Checkback contacts 11 and 12 faulty.	Replace safety relays.	
	<input type="radio"/>					Enable contact(s) of K1 and K2 faulty.	Perform a voltage reset.	

## Application manual for PSRclassic and PSRmultifunction, and the modular safety relay system

The table is valid for the following safety relays:

- 1 PSR-URML4/3x1/1x2/B

Table 8-7 Diagnostic description for PSR-URML4/3x1/1x2/B safety relay

	K1	K2				Fault	Remedy
Connection/ voltage error	○	○				0 V not applied.	Apply 0 V.
	○	○				Sensor circuits S12 and S22 are not being supplied with power.	Check the circuit connection.
	○	●				Sensor circuit S12 is not being supplied with power.	
	●	○				Sensor circuit S22 is not being supplied with power.	
Short circuit	○	○				Between contact points S12 and 0 V or between S22 and 0 V.	Remove short circuit.
Fault with internal cause	○	●				Enable contact(s) of K1 faulty.	Replace safety relays.
	●	○				Enable contact(s) of K2 faulty.	Perform a voltage reset.
	○	○				Enable contact(s) of K1 and K2 faulty.	

The table is valid for the following safety relays:

1 PSR-SDC4/2x1/B

Table 8-8 Diagnostic description for PSR-SDC4/2x1/B safety relay

	PWR	IN1	IN2	K1	K2	Fault	Remedy
Connection/ voltage error	○	○	○	○	○	Supply voltage not present.	Apply supply voltage.
	○	○	○	○	○	Supply voltage too low.	Adjust supply voltage.
	●	●	●	○	●		
	●	○	○	○	○	The enable circuits are connected incorrectly or not connected at all.	Check the connection of the enable circuits.
Cross-circuit	○	○	○	○	○	Between both enable circuits S11/S12-S10 and A2-S22. E.g., for emergency stop.	Remove cross-circuit.
	●	○	○	○	○	Between both enable circuits S12 and S10. The fault is not detected by the module itself. E.g., for light grid type 4.	
Short circuit	○	○	○	○	○	Between contact points A1 and A2.	Remove short circuit.
	●	●	●	●	○	Between S11 and S12 or S10 and S12. Fault detection on next demand.	
	●	●	○	●	○	Between S11 and S13. Fault is detected immediately.	
	●	●	○	●	○	Between S10 and S12. Fault is detected immediately.	
	●	●	●	○	●	Between A2 and S22. Fault detection on next demand.	
Fault in reset circuit	●	●	●	○	●	Faulty reset button. Short circuit between S33 and S34. No fault detection on initial start, only on first new demand.	Replace reset button. Remove short circuit.
	●	●	●	○	●	Enable contact(s) of K1 faulty.	Replace safety relays.
	●	●	●	●	○	Enable contact(s) of K2 faulty.	
	●	●	●	○	○	Enable contact(s) of K1 and K2 faulty.	

## Application manual for PSRclassic and PSRmultifunction, and the modular safety relay system

The table is valid for the following safety relays:

- 1 PSR-URM4/4x1/2x2/B

Table 8-9 Diagnostic description for PSR-URM4/4x1/2x2/B safety relay

	K1/K2					Fault	Remedy
Connection/ voltage error	<input type="radio"/>					Supply voltage not present.	Apply supply voltage, e.g., via the PSR-TBUS DIN rail connector.
	<input type="radio"/>					Supply voltage too low.	Adjust supply voltage.
	<input type="radio"/>					The input circuit is connected incorrectly or not connected at all.	Check the PSR-TBUS connections between the modules. Insert PSR-TBUS-TP dummy plug.
Short circuit	<input type="radio"/>					Between contact points A1 and A2.	Remove short circuit.
Fault with internal cause	<input type="radio"/>					Checkback contacts 11 and 12 faulty.	Replace safety relays.
	<input type="radio"/>					Enable contact(s) of K1 and K2 faulty.	

The table is valid for the following safety relays:

- 1 PSR-URD3/4x1/2x1/3
- 2 PSR-URD3/4x1/2x2
- 3 PSR-URD3/4x1/2x2/T2

Table 8-10 Diagnostic description for PSR-URD3/4x1/... safety relay

	PWR	K1(t)	K2(t)			Fault	Remedy
Connection/ voltage error	○	○	○			Supply voltage not present.	Apply supply voltage, e.g., via the PSR-TBUS DIN rail connector.
	●	○	○			Supply voltage too low.	Adjust supply voltage.
	○	○	○			The input circuit is connected incorrectly or not connected at all.	Check the PSR-TBUS connections between the modules. Insert PSR-TBUS-TP dummy plug.
Short circuit	○	○	○			Between contact points A1 and A2.	Remove short circuit.
Fault with internal cause	●	○	○			Checkback contacts 15 and 16 faulty.	Replace safety relays.
	●	○	●			Enable contact of K1(t) faulty.	
	●	●	○			Enable contact of K2(t) faulty.	

## Application manual for PSRclassic and PSRmultifunction, and the modular safety relay system

---

# A Appendix

## A 1 Explanation of terms

<b>AOPD</b>	Active optoelectronic protective device Device with a sensor function that is generated by optoelectronic transmit and receive elements, which detects the interruption of optical radiation generated in the device by an opaque object located in the specified protective field (or for a photoelectric barrier on the axis of the light beam). In DIN EN 692 (mechanical presses), DIN EN 693 (hydraulic presses), and EN 12622 (hydraulic trimming presses), the abbreviation AOS is used as a synonym for AOPD.
<b>AOPDDR</b>	Active optoelectronic protective device responsive to diffuse reflection Device with a sensor function that is generated by optoelectronic transmit and receive elements, which detects the diffuse reflection of optical radiation generated in the device by an object located in a protective field specified in two dimensions.
<b>ESPE</b>	Electro-sensitive protective equipment
<b>CCF</b>	Common cause failure
<b>DC</b>	Diagnostic coverage
<b>PL</b>	Performance level Classification of the ability of safety functions to meet a safety demand
<b>Cat. / Category</b>	Classification of the resistance to faults according to EN ISO 13849-1.
<b>Mission time <math>t_M</math></b>	Duration of use
<b>MTTF / <math>MTTF_D</math></b>	Mean time to failure / mean time to dangerous failure
<b>PFD</b>	Probability of failure on demand (low demand)
<b><math>PFH_D</math></b>	Average frequency of a dangerous failure per hour
<b>SIL</b>	Safety integrity level
<b>SILCL</b>	SIL claim limit
<b>SRCF</b>	Safety-related control function - safety function
<b>SRECS</b>	Safety-related electrical control system (Safety-related electrical, electronic, and programmable electronic control system)
<b>SRP / SRP/CS</b>	Safety-related part / safety-related parts of control systems

**Application manual for PSRclassic and PSRmultifunction, and the modular safety relay system**

---

---

## Please observe the following notes

### **General terms and conditions of use for technical documentation**

Phoenix Contact reserves the right to alter, correct, and/or improve the technical documentation and the products described in the technical documentation at its own discretion and without giving prior notice, insofar as this is reasonable for the user. The same applies to any technical changes that serve the purpose of technical progress.

The receipt of technical documentation (in particular user documentation) does not constitute any further duty on the part of Phoenix Contact to furnish information on modifications to products and/or technical documentation. You are responsible to verify the suitability and intended use of the products in your specific application, in particular with regard to observing the applicable standards and regulations. All information made available in the technical data is supplied without any accompanying guarantee, whether expressly mentioned, implied or tacitly assumed.

In general, the provisions of the current standard Terms and Conditions of Phoenix Contact apply exclusively, in particular as concerns any warranty liability.

This manual, including all illustrations contained herein, is copyright protected. Any changes to the contents or the publication of extracts of this document is prohibited.

Phoenix Contact reserves the right to register its own intellectual property rights for the product identifications of Phoenix Contact products that are used here. Registration of such intellectual property rights by third parties is prohibited.

Other product identifications may be afforded legal protection, even where they may not be indicated as such.

---

## How to contact us

**Internet**

Up-to-date information on Phoenix Contact products and our Terms and Conditions can be found on the Internet at:

[phoenixcontact.com](http://phoenixcontact.com)

Make sure you always use the latest documentation.

It can be downloaded at:

[phoenixcontact.net/products](http://phoenixcontact.net/products)

**Subsidiaries**

If there are any problems that cannot be solved using the documentation, please contact your Phoenix Contact subsidiary.

Subsidiary contact information is available at [phoenixcontact.com](http://phoenixcontact.com).

**Published by**

PHOENIX CONTACT GmbH & Co. KG  
Flachsmarktstraße 8  
32825 Blomberg  
GERMANY

PHOENIX CONTACT Development and Manufacturing, Inc.  
586 Fulling Mill Road  
Middletown, PA 17057  
USA

Should you have any suggestions or recommendations for improvement of the contents and layout of our manuals, please send your comments to:

[tecdoc@phoenixcontact.com](mailto:tecdoc@phoenixcontact.com)



PHOENIX CONTACT GmbH & Co. KG  
Flachmarktstraße 8  
32825 Blomberg, Germany  
Phone: +49 5235 3-00  
Fax: +49 5235 3-41200  
E-mail: [info@phoenixcontact.com](mailto:info@phoenixcontact.com)  
[phoenixcontact.com](http://phoenixcontact.com)

© PHOENIX CONTACT 2019-04-04

102597\_en\_03



# SCATTERGOOD & JOHNSON LTD

ELECTRICAL ENGINEERING & FLUID CONTROL DISTRIBUTORS

Est.1899

At Scattergood & Johnson Ltd, we pride ourselves on being a technical distributor to specialist industries.

Working with a range of quality product suppliers across a number of specialist markets, we are not your average 'box shifter' - we are your technical and supply chain partner.

We fully support every product we sell - for free! Our internal team and external sales engineers can answer any product or application question, no matter the complexity.

Backing up this technical ability is a range of 50,000+ products available from stock for nationwide next day delivery (same day if required!), or you can collect what you need from any of our trade counters around the UK.

Select your specialist interest below to learn more about how we can help.

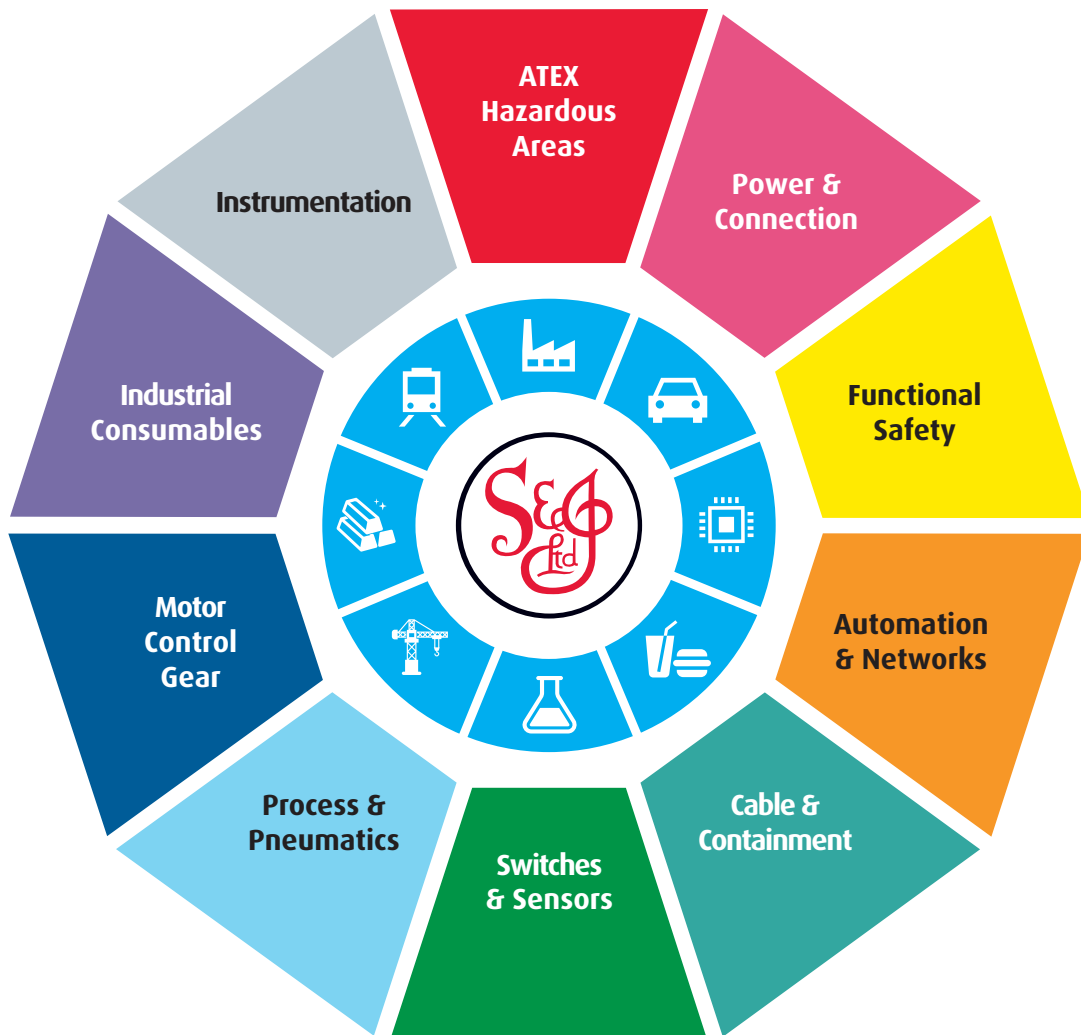

Online, In Branch and On the Road - Scattergood & Johnson Ltd, there when you need us.

# [www.scatts.co.uk](http://www.scatts.co.uk)