

# eXware Series

## Operating Instructions



Copyright © 2018-2019 Exor International S.p.A. – Verona, Italy  
Subject to change without notice

The information contained in this document is provided for informational purposes only. While efforts were made to verify the accuracy of the information contained in this documentation, it is provided “as is” without warranty of any kind.

Third-party brands and names are the property of their respective owners.

[www.exorint.com](http://www.exorint.com)



# Table of Contents

Introduction	4
Safety Guide	5
1 Product Overview	6
2 Standards and Approvals	7
3 Technical Specifications	9
4 Technical Data	11
4.1 Dimensions	12
4.2 Safety instruction	13
4.3 Installation Procedure	13
5 Connections	14
5.1 Serial Port	16
5.2 Ethernet Port	16
5.3 Optional plugin module	17
5.4 Optional plugin module identification	18
5.5 Optional plugin module installation procedure	19
6 Power Supply, Grounding and Shielding	22
7 Battery	23
8 Special Instruction for Use	24
9 Getting Started	24
10 System Settings	25
11 Unpacking and Packing Instructions	27



# Introduction

The operational guidelines described below is information which relates to the device, installation, transportation, storage, assembly, use and maintenance.

This Operating Instruction describes the main features of the Exor eXware. The Manual refers to the following models:

eXware703	Embedded controller with 2 Ethernet port
eXware707	Embedded controller with 3 Ethernet port, Dual Core ARM Cortex-A9 CPU
eXware707Q	Embedded controller with 3 Ethernet port, Quad Core ARM Cortex-A9 CPU



# Safety Guide

The manual contains safety standards that must be respected for the personal safety and to avoid damage. Indications of attention are divided into three levels of severity:

**DANGER:** indicates a failure to observe safety rules and such failure may cause death or serious injuries.



**ATTENTION:** indicates a failure to observe safety rules and that deficiency may cause damage.



**CAUTION:** indicates a failure to observe safety rules and that deficiency may cause defects to the equipment or inconsistencies.





# 1 Product Overview

With the combination of JMobile HMI, CODESYS PLC and Corvina Cloud security, eXware offers companies the chance to start at an uncomplicated level in IoT and yet allows enormous future expansion into more complex aspects of Industry 4.0. Speaking across the vast library of JMobile protocols as well as OPC UA to higher enterprise level control, the eXware is a true Plug and Use product. Straightforward wireless connectivity using the optional PLCM09 2G/3G modem.

- Compatible with Existing Installations
- Compatible with JMobile. Includes JM4web HTML5 access.
- Supports JMobile protocols including OPC UA server and client.
- Compatible with CODESYS V3. Supports network stacks and local I/O expandability
- Compatible with Corvina Cloud secure remote connectivity.
- Compatible with PLCM09 2G/3G modem.
- 2 Ethernet ports for network separation WAN/LAN.
- System settings by web browser.
- Linux-based open platform.



## 2 Standards and Approvals

The products have been designed for use in an industrial environment in compliance with the 2014/30/EU EMC Directive.

The products have been designed in compliance with:

EN 61000-6-4      CISPR 22      Class A  
                         CISPR 16-2-3

EN 61000-6-2      EN 61000-4-2  
                         EN 61000-4-3  
                         EN 61000-4-4  
                         EN 61000-4-5  
                         EN 61000-4-6  
                         EN 61000-4-8  
                         EN 61000-4-11  
                         EN 61000-4-29

EN60945

IECEX

IEC 60079-0, Ed.6  
IEC 60079-15, Ed.4  
IEC 60079-31, Ed.2

IECEX: IECEX ULD 17.0019X

Ex nA IIC T5...T4 Gc 0°C≤Tamb≤+50°C or -20°C≤Tamb≤+60°C  
Ex tc IIIC T95°C Dc

ATEX

EN 60079-0: 2012+A11:2013  
EN 60079-15: 2010  
EN 60079-31: 2014



DEMKO 17 ATEX 1871X

II 3G Ex nA IIC T5...T4 Gc 0°C≤Tamb≤+50°C or -20°C≤Tamb≤+60°C  
II 3D Ex tc IIIC T95°C Dc

The installation of these devices into the residential, commercial and light-industrial environments is allowed only in the case that special measures are taken in order to ensure conformity to EN 61000-6-3.

The products are in compliance with the Restrictions on Certain Hazardous Substances (RoHS) Directive 2011/65/EU

In compliance with the above regulations the products are CE marked.



## 2 Standards and Approvals

### Product Identification

The product may be identified through a plate attached to the rear cover. You will have to know the type of unit you are using for correct usage of the information contained in the guide.

An example of this plate is shown in the figure below:

Note: the eXware703 label is used as an example for eXware Series

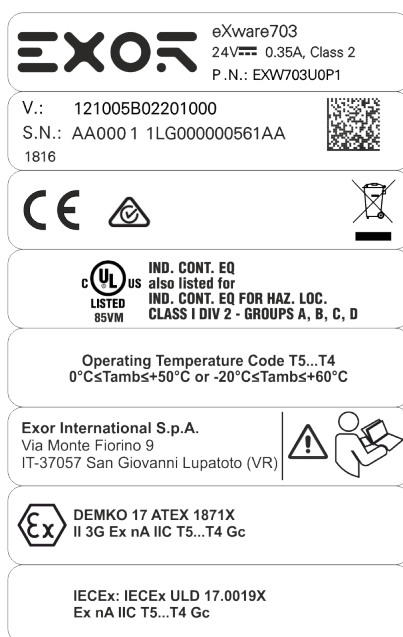

product model name	eXware703
product part number	EXW703U0P1
year/week of production	1816
serial number	AA00011LG000000561AA
version id of the product	121005B02201000
manufacturer address	Exor International S.p.A. Via Monte Fiorino 9 IT-37057 San Giovanni Lupatoto (VR)
ATEX Marking	 DEMKO 17 ATEX 1871X II 3G Ex nA IIC T5...T4 Gc 0°C ≤ Tamb ≤ +50°C or -20°C ≤ Tamb ≤ +60°C
IECEX Marking IECEX:	IECEX ULD 17.0019X Ex nA IIC T5...T4 Gc 0°C ≤ Tamb ≤ +50°C or -20°C ≤ Tamb ≤ +60°C



## 3 Technical Specifications

<b>Back-up battery</b>	3V 50mAh Lithium, rechargeable, not user-replaceable, model VL2330.	
<b>Fuse</b>	Automatic	
<b>Serial Port</b>	RS-232, RS-485, RS-422 software configurable	
<b>Flash</b>	4GB for eXware703, eXware707, 8GB for eXware707Q	
<b>RAM</b>	512MB for eXware703, 1GB for eXware707, 2GB for eXware707Q	
<b>Hardware clock</b>	Clock/Calendar with back-up battery	
<b>Accuracy RTC (at 25°C)</b>	<100ppm	
<b><i>Environmental conditions</i></b>		
<b>Operating temperature (surrounding air temperature)</b>	-20 ÷ +60°C (vertical installation) Plug-in modules and USB devices may limit max temperature to +50°C	EN 60068-2-14
<b>Storage temperature</b>	-20 ÷ +70°C	EN 60068-2-1 EN 60068-2-2 EN 60068-2-14
<b>Operating and storage humidity</b>	5 ÷ 85 % RH not-condensing	EN 60068-2-30
<b>Vibrations</b>	5 ÷ 9 Hz, 7 mm <sub>p-p</sub> 9 ÷ 150 Hz, 1 g	EN 60068-2-6
<b>Shock</b>	± 50 g, 11 ms, 3 pulses per axis	EN 60068-2-27
<b>Protection class</b>	IP20	EN 60529
<b><i>Electromagnetic Compatibility (EMC)</i></b>		
<b>Radiated disturbance test</b>	Class A	CISPR 22 CISPR 16-2-3
<b>Electrostatic discharge immunity test</b>	8 kV (air electrostatic discharge) 4 kV (contact electrostatic discharge)	EN 61000-4-2
<b>Radiated, radio-frequency, electromagnetic field immunity test</b>	80 MHz ÷ 1 GHz, 10V/m 1,4 GHz ÷ 2 GHz, 3 V/m 2 GHz ÷ 2.7 GHz, 1 V/m	EN 61000-4-3
<b>Burst immunity test</b>	± 2 KV dc power port ± 1 KV signal line	EN 61000-4-4
<b>Surge immunity test</b>	± 0,5 KV dc power port (line to earth) ± 0,5 KV dc power port (line to line) ± 1 KV signal line (line to earth)	EN 61000-4-5
<b>Immunity to conducted disturbances induced by radiofrequency field</b>	0.15 ÷ 80 MHz, 10V	EN 61000-4-6
<b>Power frequency magnetic field immunity test</b>	Enclosure, 50/60Hz, 30A/m	EN 61000-4-8



## 3 Technical Specifications

### **Voltage dips, short interruptions and voltage variations immunity test**

Port: AC mains; Level:	
100% duration:	1 cycle and 250 cycles (50Hz); 1 cycle and 300 cycles (60Hz);
40% duration:	10 cycles (50Hz); 12 cycles (60Hz);
70% duration:	25 cycles (50Hz); 30 cycles (60Hz);
Phase: 0°-180°	

Test executed on the 230Vac side of the Exor International S.p.A. Power Supply EN 61000-4-11

Port: DC mains; Level:	
0% duration:	10ms 20 spaces by 1s

Test executed on the 24Vdc of the EUT EN 61000-4-29



## 4 Technical Data

Model	eXware703	eXware707	eXware707Q
<b>Flash</b>	4GB	4GB	8GB
<b>SD card slot</b>	yes	yes	yes
<b>RAM</b>	512MB	1GB	2GB
<b>Serial Port</b>	RS-232,RS-485, RS-422 software configurable	RS-232,RS-485, RS-422 software configurable	RS-232,RS-485, RS-422 software configurable
<b>Ethernet port</b>	2 10/100Mb	2 10/100Mb, 1 10/100/1000Mb	2 10/100Mb, 1 10/100/1000Mb
<b>USB port</b>	1 Host interface version 2.0 max. 500mA	2 Host interface version 2.0 max. 500mA	2 Host interface version 2.0 max. 500mA
<b>Expansion slot</b>	1 Optional Plugin	2 Optional Plugin	2 Optional Plugin
<b>Battery</b>	rechargeable	rechargeable	rechargeable
<b>Real Time Clock</b>	yes	yes	yes
<b>Voltage</b>	24Vdc (*)	24Vdc (*)	24Vdc (*)
<b>Current rating (at 24VDC)</b>	0.35A	0.50A	0.55A
<b>Weight</b>	0.6 Kg	0.7 Kg	0.7 Kg

(\*) 10-32Vdc

For applications requiring compliance with EN 61131-2 and specifically in reference to 10 ms voltage dips, the power supply range voltage is 18-32Vdc.



# 4 Technical Data

## 4.1 Dimensions

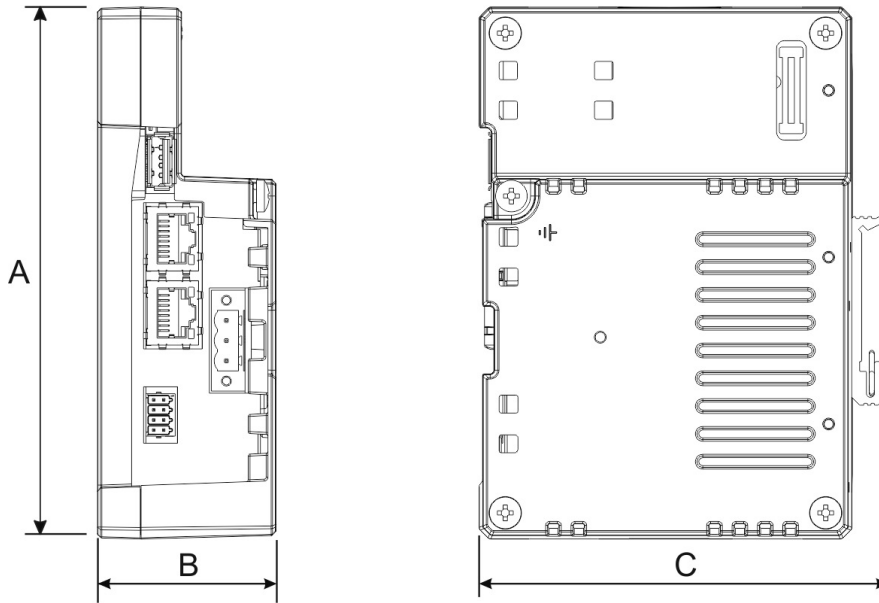

MODEL	A	B	C
<b>eXware703</b>	134mm/5.27"	45mm/1.77"	103mm/4.05"



## 4 Technical Data

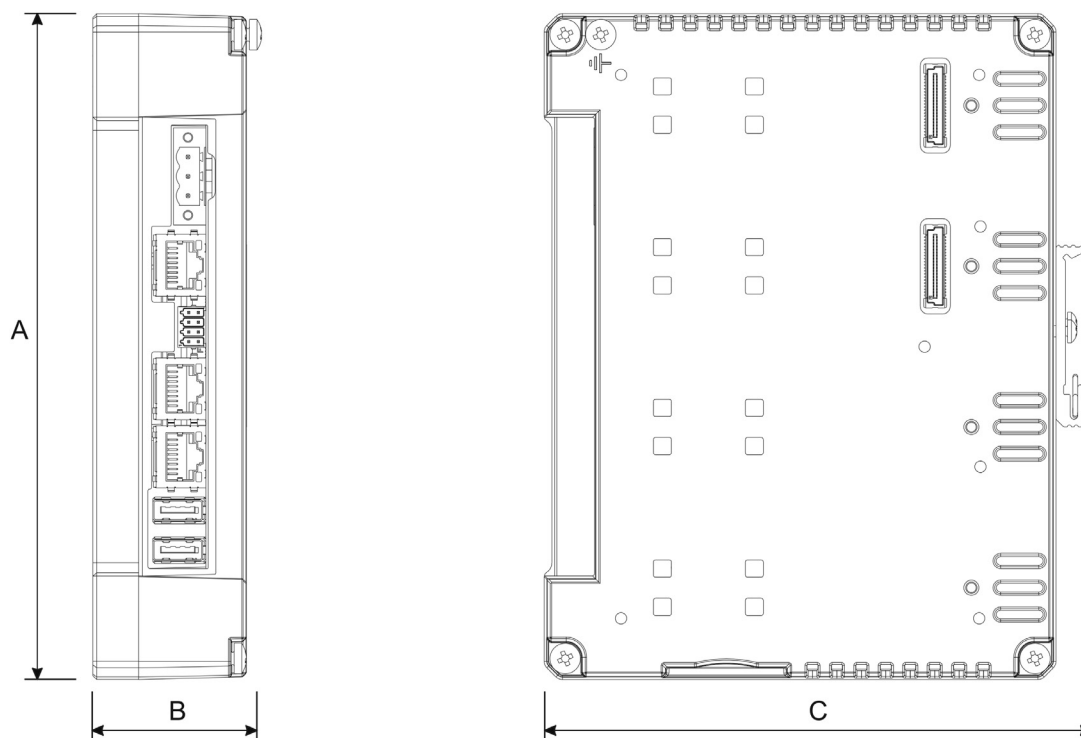

MODEL	A	B	C
<b>eXware707</b>	174mm/6.85"	44mm/1.73"	144mm/5.67"
<b>eXware707Q</b>	174mm/6.85"	44mm/1.73"	144mm/5.67"

### 4.2 Safety instruction



For all installation notes, please refer to the Installation Guide provided with the product.

### 4.3 Installation Procedure

The eXware series must be mounted on a TS35 DIN rail



## 5 Connections

eXware703

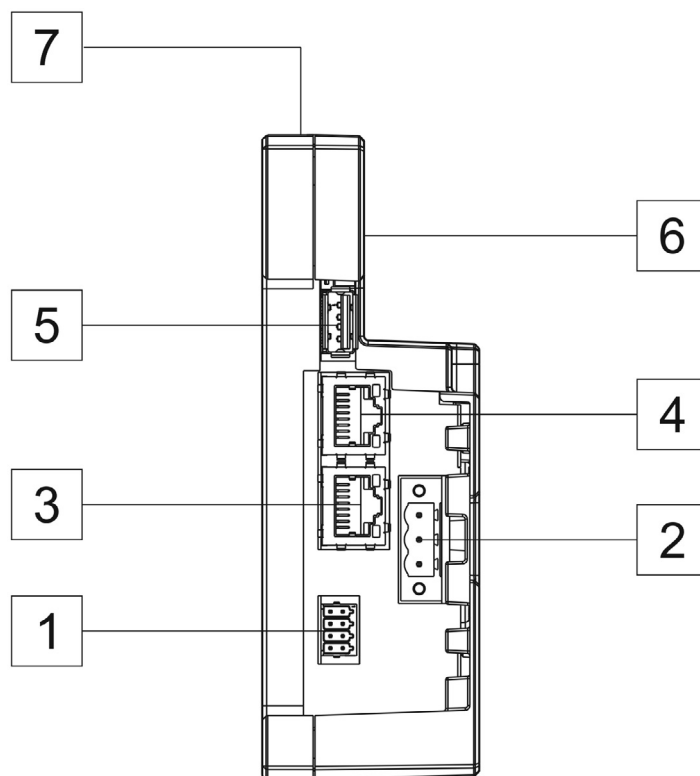

**Fig. 5.1**

1. Serial Port
2. Power Supply
3. Ethernet Port 1 (10/100Mb)
4. Ethernet Port 0 (10/100Mb)
5. USB Port V2.0, max 500 mA - for maintenance only
6. Expansion Slot for Plugin module
7. SD Card Slot



## 5 Connections

eXware707, eXware707Q

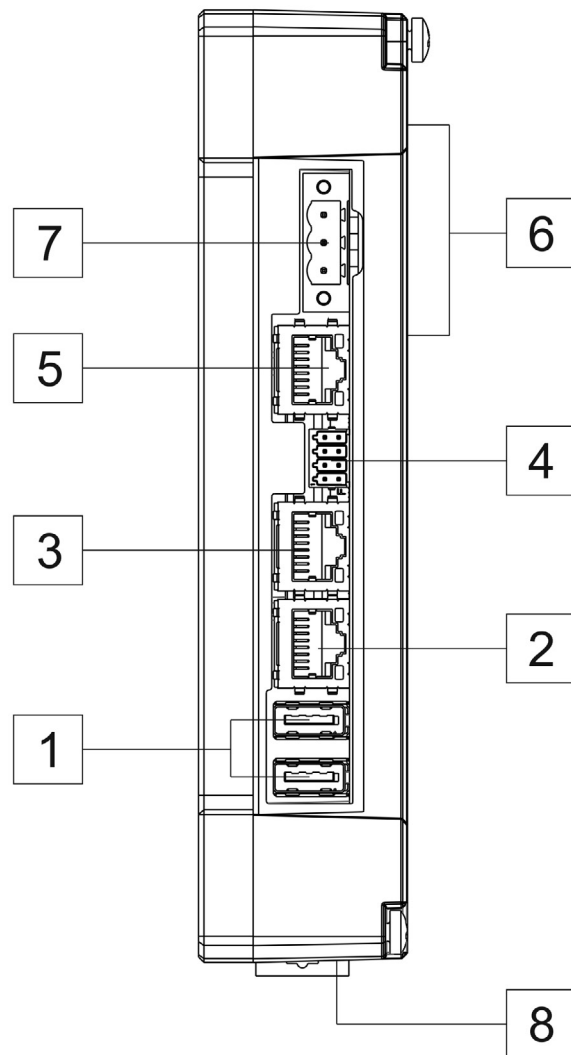

Fig. 5.2

1. USB Port V2.0, max 500 mA - for maintenance only
2. Ethernet Port 2 (10/100Mb)
3. Ethernet Port 1 (10/100Mb)
4. Serial Port
5. Ethernet Port 0 (10/100/1000Mb)
6. 2x Expansion slot for Plugin module
7. Power Supply
8. SD Card Slot



# 5 Connections

## 5.1 Serial Port

The serial port is used to communicate with the PLC or with another type of controller. Different electrical standards are available for the signals in the PLC port connector: RS-232, RS-422, RS-485.

The serial port is software programmable. Make sure you select the appropriate interface in the programming software.

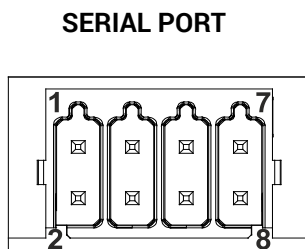

RS-232	
Pin	Description
1	RX
2	TX
3	CTS
4	RTS
5	+5V output
6	GND
7	
8	SHIELD

RS-422, RS-485	
Pin	Description
1	CHB-
2	CHA-
3	CHB+
4	CHA+
5	+5V output
6	GND
7	
8	SHIELD

To operate in RS-485 pins 1-2 and 3-4 must be connected externally.

The communication cable must be chosen for the type of device being connected.

## 5.2 Ethernet Port

The Ethernet port have two status indicators. Please see description in figure.

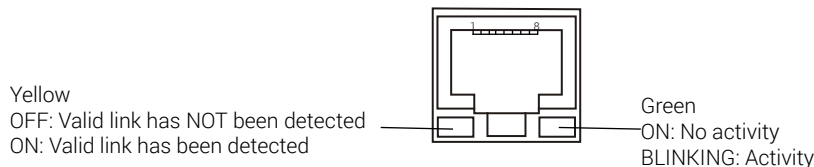

### Factory settings:

ETH0 / WAN: DHCP  
 ETH1 / LAN: IP Address 192.168.0.1 Subnet mask: 255.255.255.0  
 ETH2 / LAN: DHCP only for eXware707 and eXware707Q  
 Settings: [https://192.168.0.1/machine\\_config](https://192.168.0.1/machine_config)  
 Username: admin  
 Password: admin



# 5 Connections

## 5.3 Optional plugin module

eXware Series panels have several optional plugin module, multiple modules configurations are possible.

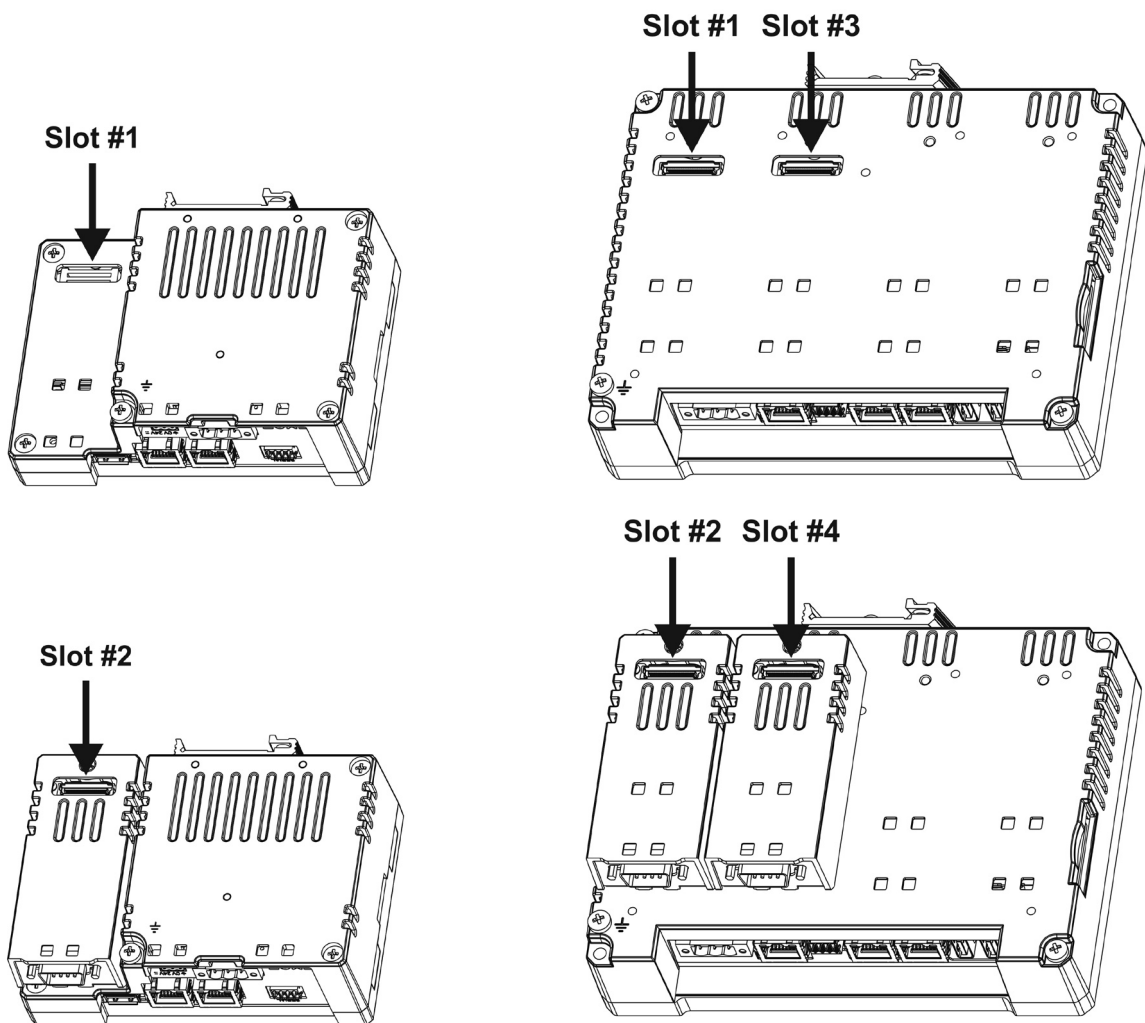

Slot#2 and Slot#4 are available only if plugin module has the "bus extension connector".

Each slot carries three communication channels:

- 1 serial interface
- 1 CAN interface
- 1 SPI interface
- 1 2G/3G interface

Note: It is not possible to stack two modules that are using the same type of interface.



## 5 Connections

### 5.4 Optional plugin module identification

Note: the PLCM01 label is used as an example for PLCM01, PLCM05, PLCM09X, PLI003

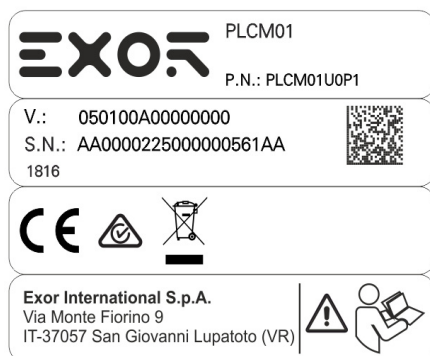

product model name	PLCM01
product part number	PLCM01U0P1
year/week of production	1816
serial number	AA0000225000000561AA
version id of the product	050100A000000000
manufacturer address	Exor International S.p.A. Via Monte Fiorino 9 IT-37057 San Giovanni Lupatoto (VR)



# 5 Connections

## 5.5 Optional plugin module installation procedure

PLCM

PLI003

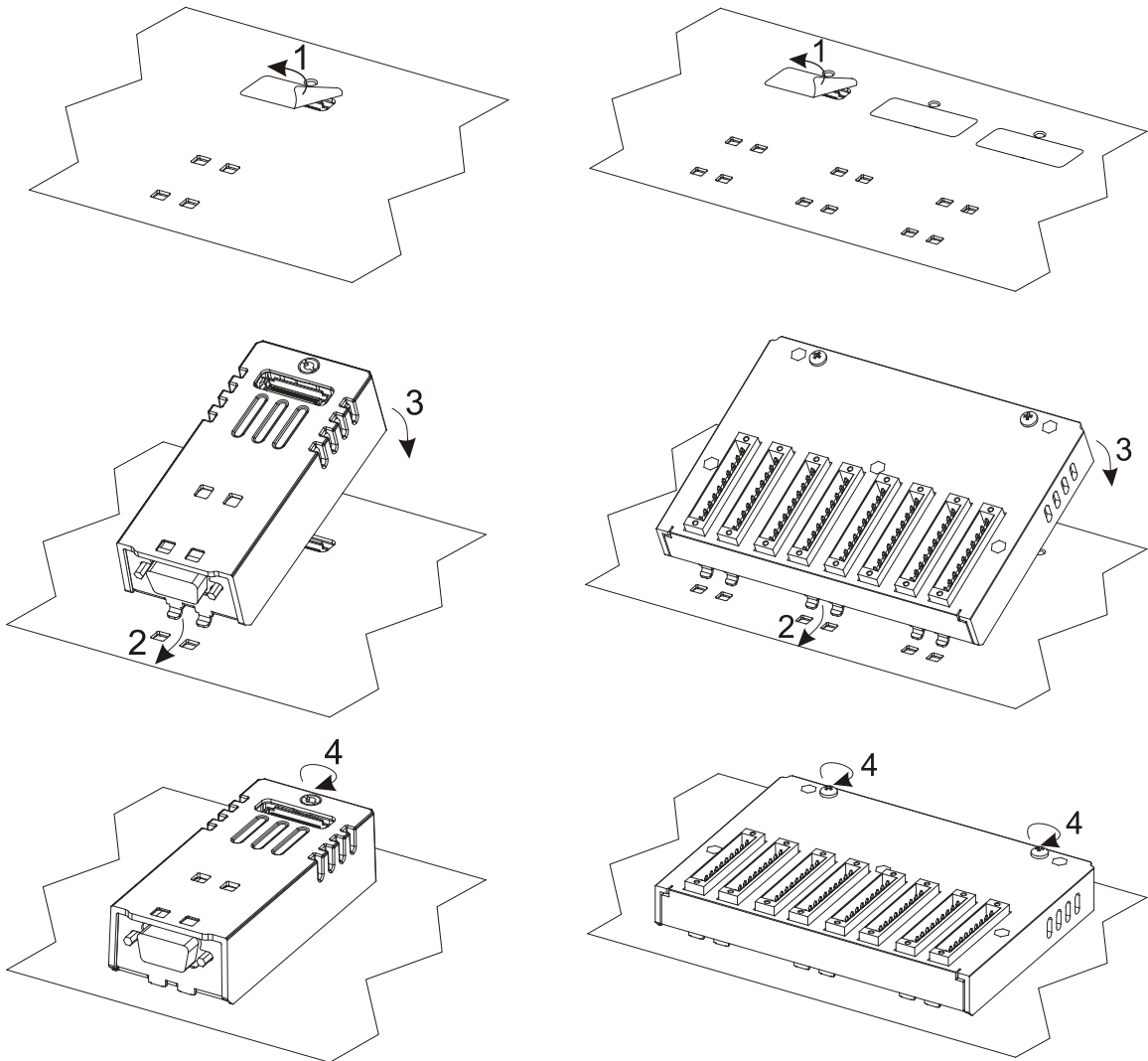



## 5 Connections

Below you can find relation between modules ATEX and IECEx certified and max number of modules that can be used into eXware serie panels, based on their Interface Type:

Module	Application	Max Modules	Interface Type	Bus Extension connector
<b>PLCM01</b>	CAN	1 for eX705 2 for other panels	CAN	Y
<b>PLCM01-NE</b>	CAN	1 for eX705 2 for other panels	CAN	N
<b>PLCM05</b>	CODESYS License	1		Y
<b>PLCM09X</b>	3G modem	1		Y
<b>PLIO03</b>	Multifunction I/O	1	SPI	N

PLCM01 / PLCM01-NE: Operating temperature -20°C to 60°C  
 PLCM05: Operating temperature -20°C to 60°C  
 PLCM09X: Operating temperature -20°C to 60°C  
 PLIO03: with part number PLIO03xxxxY where:  
 - Y≤2 is operating temperature range 0°C≤Tamb≤+50°C with Operating Temperature Code T5 (vertical installation), 12-30VDC  
 - Y>2 is operating temperature range -20°C≤Tamb≤+60°C with Operating Temperature Code T4 (vertical installation), 12-30VDC



Note the above different "Operating Temperature Code" for different part number of PLIO03 module.

PLCM and PLIO03 electrical ratings:

- PLCM01: For electrical rating refers to the host eXware models.
- PLCM05: For electrical rating refers to the host eXware models and PLIO03 ratings
- PLCM09X: 2xDigital Inputs voltage 12÷30 Vdc, 3mA; 2xDigital Outputs voltage 12÷30 Vdc, 0.5A
- PLIO03: 20xDigital Inputs voltage 12÷30 Vdc; 12xDigital Outputs voltage 12÷30 Vdc, 0.5A; 4xAnalog inputs 0÷10 Vdc, 4-20mA; 4xAnalog outputs: 0÷10 Vdc, 4-20mA



## 5 Connections

Below you can find relation between modules and max number of modules that can be used into eXware series panels, based on their Interface Type:

Module	Application	Max Modules	Interface Type	Bus Extension connector
<b>PLCM02</b>	KNX	1	Serial	N
<b>PLCM03</b>	Serial RS232	2	Serial	Y
<b>PLCM04</b>	Serial RS485	2	Serial	Y
<b>PLCM06</b>	Profibus DP	1	SPI	N
<b>PLCM07</b>	Ethernet	1	Ethernet	N
<b>PLCM09</b>	3G modem	1		Y
<b>PLIO06</b>	Compact I/O	2	SPI	N

Max modules refers to max number of modules can be plugged into the eXware (all slots),

If you are planning to use PLCM03 and PLCM04 (additional serial ports) you will obtain following "COM - Slot#" association:

- a module plugged in Slot#1 or into Slot#2 will be COM2,
- a module plugged in Slot#3 or into Slot#4 will be COM3.

If you are planning to use two PLCM01 (CAN interface) you will obtain following Slot# association:

- a module plugged in Slot#1 or into Slot#2 will be the CanPort 0,
- a module plugged in Slot#3 or into Slot#4 will be the CanPort 1.



## 6 Power Supply, Grounding and Shielding

The power supply terminal block is shown in the figure below.

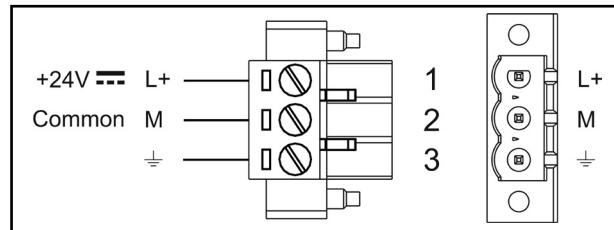

**Fig. 6.1**

3 conductor 1,5mmq wire size minimum, minimum temperature conductor rating 105°C.

**Note:** Ensure that the power supply has enough power capacity for the operation of the equipment.

The unit must always be grounded to earth with 1,5mmq wire size minimum. Grounding helps limit the effects of noise due to electromagnetic interference on the control system.

Earth connection will have to be done using either the screw or the faston terminal located near the power supply terminal block. A label helps identify the ground connection. Also connect to ground the terminal 3 on the power supply terminal block.

The power supply circuit may be floating or grounded. In the latter case, connect to ground the power source common as shown in figure (see below) with a dashed line.

When using the floating power scheme, note that the panes internally connects the power common to ground with a 1MΩ resistor in parallel with a 4,7nF capacitor.

The power supply must have double or reinforced insulation.

The suggested wiring for the power supply is shown below.

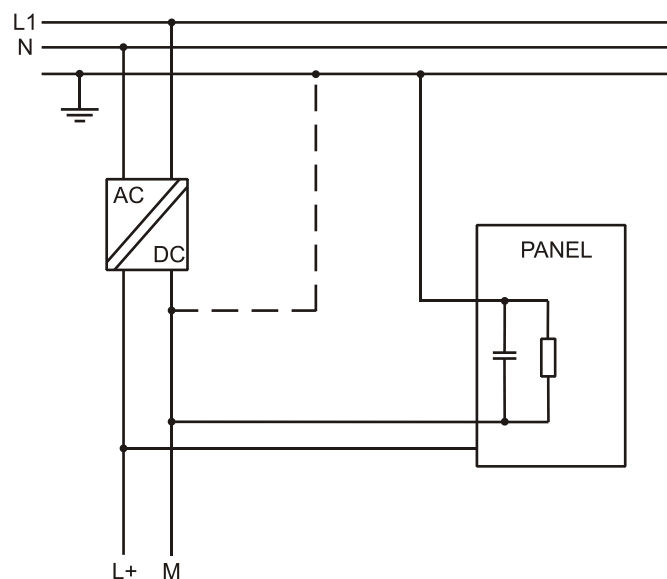

**Fig. 6.2**

All the electronic devices in the control system must be properly grounded. Grounding must be performed according to applicable regulations.



# 7 Battery

These devices are equipped with rechargeable Lithium battery, not user-replaceable.  
 The following information is maintained by the battery:

- hardware real-time clock (date and time)

**Charge:**

At first installation must be charged for 48 hours.

When the battery is fully charged, it ensures a period of 3 months of data back-up at 25°C.

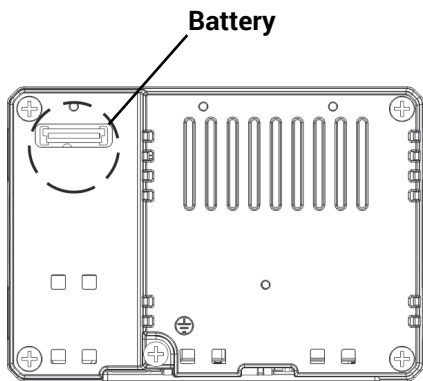

**Fig. 7.1: eXware703**

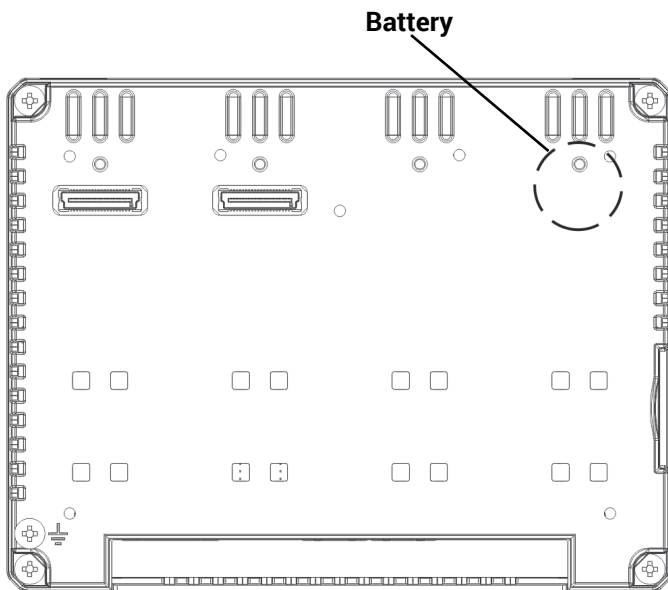

**Fig. 7.2: eXware707, eXware707Q**

**⚠ ATTENTION** Dispose of batteries according to local regulations.

**⚠ ATTENTION** This device cannot be disposed of as a domestic waste but according to WEEE European Directive 2012/19/EU 



## 8 Special Instruction for Use

- The equipment shall only be used in an area of not more than pollution degree 2, as defined in IEC/EN 60664-1.
- The equipment shall be installed in an enclosure that provides a degree of protection not less than IP 54 in accordance with IEC/EN 60079-15.
- Transient protection shall be provided that is set at a level not exceeding 140 % of the peak rated voltage value at the supply terminals to the equipment.
- Install the embedded controller according to the accompanying installation instructions.
- Ground the embedded controller according to the accompanying installation instructions.
- Only qualified personnel may install the embedded controller or repair it.
- Ensure that the aeration holes are not covered.
- This device should not be used for purposes and methods other than indicated in this document and in the documentation accompanying the product.

## 9 Getting Started

Delivery configuration of software in eXware Series products is based on a loader. You may use the services of the loader to install applications on the device such as JMobile runtime. Use System Settings to activate Cloud Service.

JMobile Studio version V2.6 or higher is required. JMobile Studio is a software tool that must be properly installed on a computer running Microsoft Windows.

There are two options to transfer a JMobile application project to an eXware device:

- |          |   |
|----------|---|
| Ethernet | Connect the eXware to the computer with an Ethernet network. In JMobile Studio select the command Run/Download to target. You may have to ensure that the proper firewall policy has been configured in the computer to allow JMobile Studio to access the network. |
| USB      | Create an Update Package using JMobile Studio and copy it to a USB Flash drive.   |



# 10 System Settings

eXware Series products have a system settings interface to allow configuration of system options. The user interface of System Settings is based on HTML pages accessible remotely using a Web browser Chrome v44 or higher at port 443. To connect enter the address `https://IP/machine_config` where IP is the IP address of the eXware device. Default username is "admin", default password is "admin". Use navigation menu on left side of the screen to browse through available options.

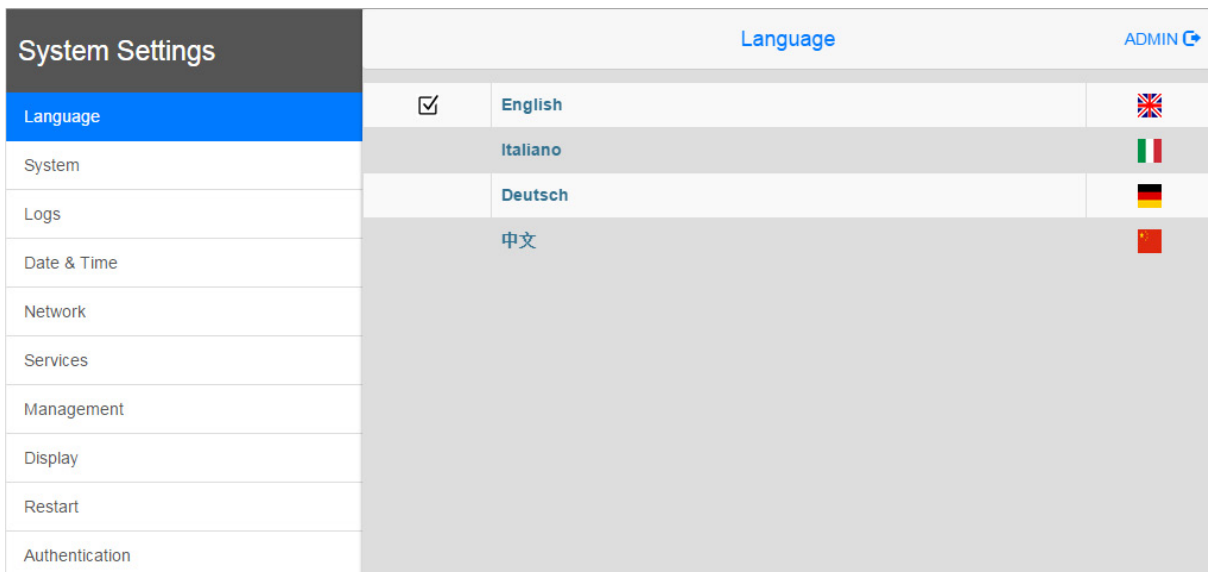

The active item of menu is highlighted on the left side of the screen. The right side shows related information and settings.

System Settings has two modes of operation:

- User Mode** JMobile runtime or Cloud Service is running or the device is in "factory default" status.
- System Mode** JMobile runtime or Cloud Service is not running or the device has a software failure. System Mode includes all options available in User Mode and additionally includes commands dedicated to system upgrade and recovery not available when running in User Mode.



# 10 System Settings

**System Settings** includes options for basic settings of the device:

<b>Language</b>	Configure language used for System Setting menu only.
<b>System</b>	Show information about platform, status and timers (like System on time, backlight on time).
<b>Logs</b>	Enable persistent log for BSP and allows exporting it.
<b>Date &amp; Time</b>	Change the device date and time, including time zone and NTP Server
<b>Network</b>	Configure IP Address of Ethernet interfaces and other network settings such as DNS, Gateway, DHCP, Hostname, routing and bridging.
<b>Services</b>	Enable/disable services. Examples of services are: SSH server, Bridge, Cloud, Router, SNMP and logging.
<b>Management</b>	Update of BSP components (Main OS, Config OS, Boot loader, XLoader), check for partitions consistence, update of splash screen, information about usage and size of partitions. The update of Main OS is available only in System Mode, the update of Config OS is only in User Mode.
<b>Restart</b>	Restart the device. "Main OS" option restarts the device in User Mode, "Config OS" option restarts the device in System Mode showing System Settings.
<b>Authentication</b>	Configure password for administrator ("admin") and for the standard user ("user"). Administrator has full access to System Settings (updates of BSP and other system components). Standard user has some limitations.

**Note:** *Additional information on System Settings are available in dedicated manual.*



# 11 Unpacking and Packing Instructions

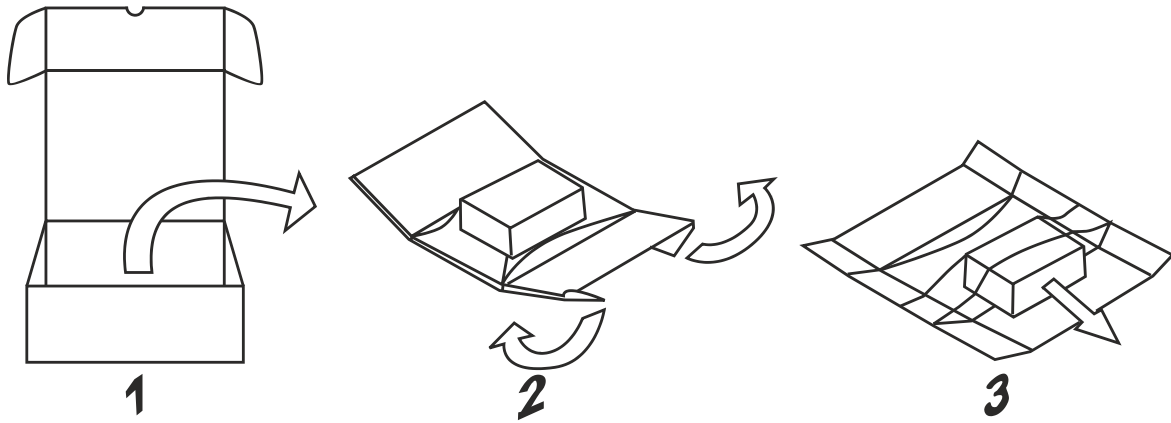

To repack the unit, please follow the instructions backwards.



# SCATTERGOOD & JOHNSON LTD

ELECTRICAL ENGINEERING & FLUID CONTROL DISTRIBUTORS

Est.1899

At Scattergood & Johnson Ltd, we pride ourselves on being a technical distributor to specialist industries.

Working with a range of quality product suppliers across a number of specialist markets, we are not your average 'box shifter' - we are your technical and supply chain partner.

We fully support every product we sell - for free! Our internal team and external sales engineers can answer any product or application question, no matter the complexity.

Backing up this technical ability is a range of 50,000+ products available from stock for nationwide next day delivery (same day if required!), or you can collect what you need from any of our trade counters around the UK.

Select your specialist interest below to learn more about how we can help.

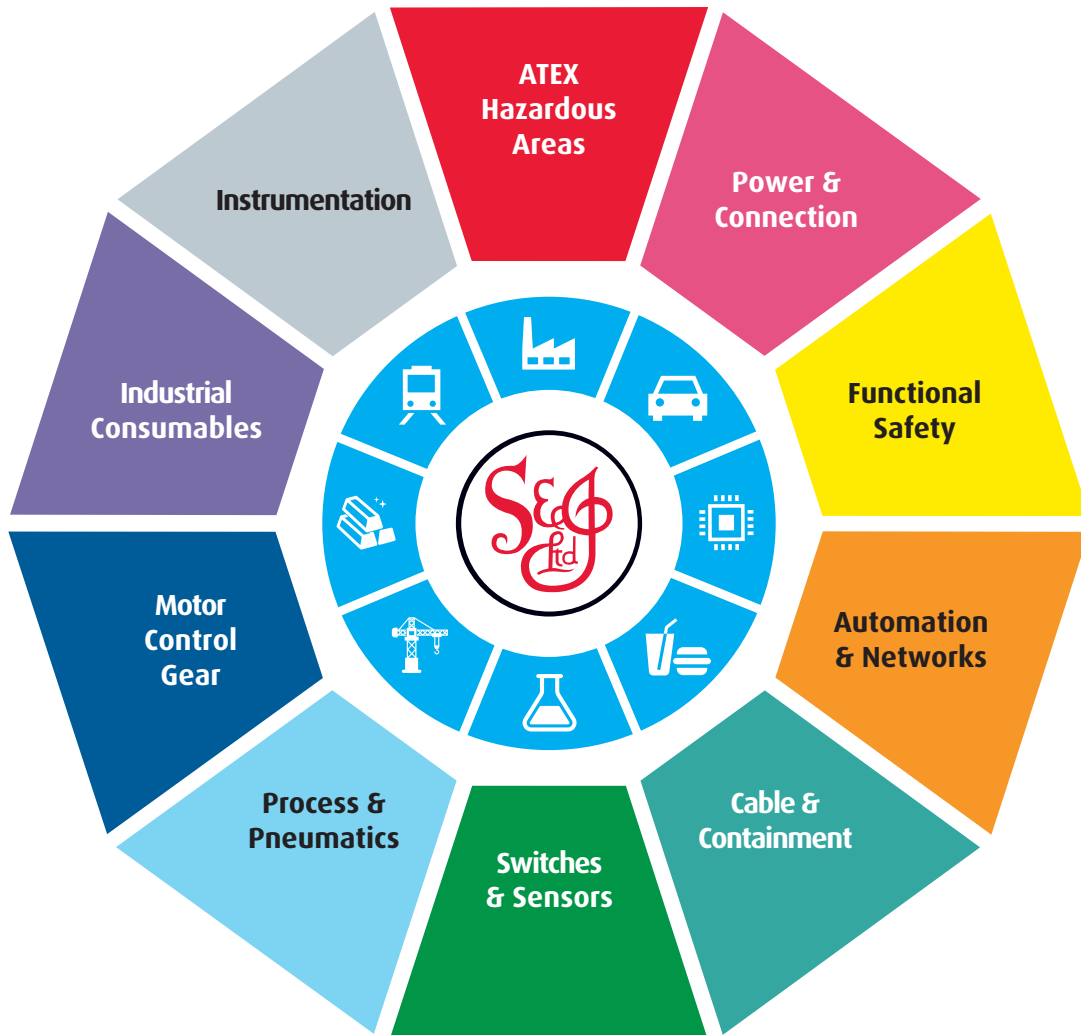

Online, In Branch and On the Road - Scattergood & Johnson Ltd, there when you need us.

# [www.scatts.co.uk](http://www.scatts.co.uk)