

Design multi-tone sounder / Multi-t.sounder 144

Multi-t.sounder BWM 32 tne 230VAC BK/GY

Part No.: 144.000.68

**MECHANICAL DATA**

Length	113 mm
Width	109 mm
Height	150 mm
Materials	PC/ABS
Housing colour	Black
Protection category	IP65
Connection	Spring-type terminal
cross-sectional area maximum	1,50mm ² / 16AWG
Cable entry	Membrane grommet
Cable entry minimum	d = 1 mm
Cable entry maximum	d = 13 mm
Type of fixing	Base mounting Wall mounting
Service life optical	5,000 h minimum
Acoustic service life	5,000 h minimum
Working temperature minimum	-30°C
Working temperature maximum	+50°C
Weight with packaging	520 g
Product weight	450 g

ELECTRICAL DATA

Operating voltage	230V
Operating voltage type	AC
Operating voltage type	50Hz
Operating voltage tolerance	+/- 10%
Rated operational voltage	230 VAC
Rated operational current	30 mA
Rated inrush current	100 mA
Protection class	Protection class 2
Pollution degree	3
Overvoltage category	II
Isolation voltage	Ui = 250V; Uimp = 2.500V

ACUSTICAL DATA

Volume/dB(max) at 1m distance	114,0 dB (A)
Acoustic signal image	Multi-tone
Number of tones	32 tone



For additional installation and mounting information, refer to the appropriate user guide at www.werma.com. This printed copy is for information only and is subject to alteration.

Design multi-tone sounder / Multi-t.sounder 144

Multi-t.sounder BWM 32 tne 230VAC BK/GY

DRAWING

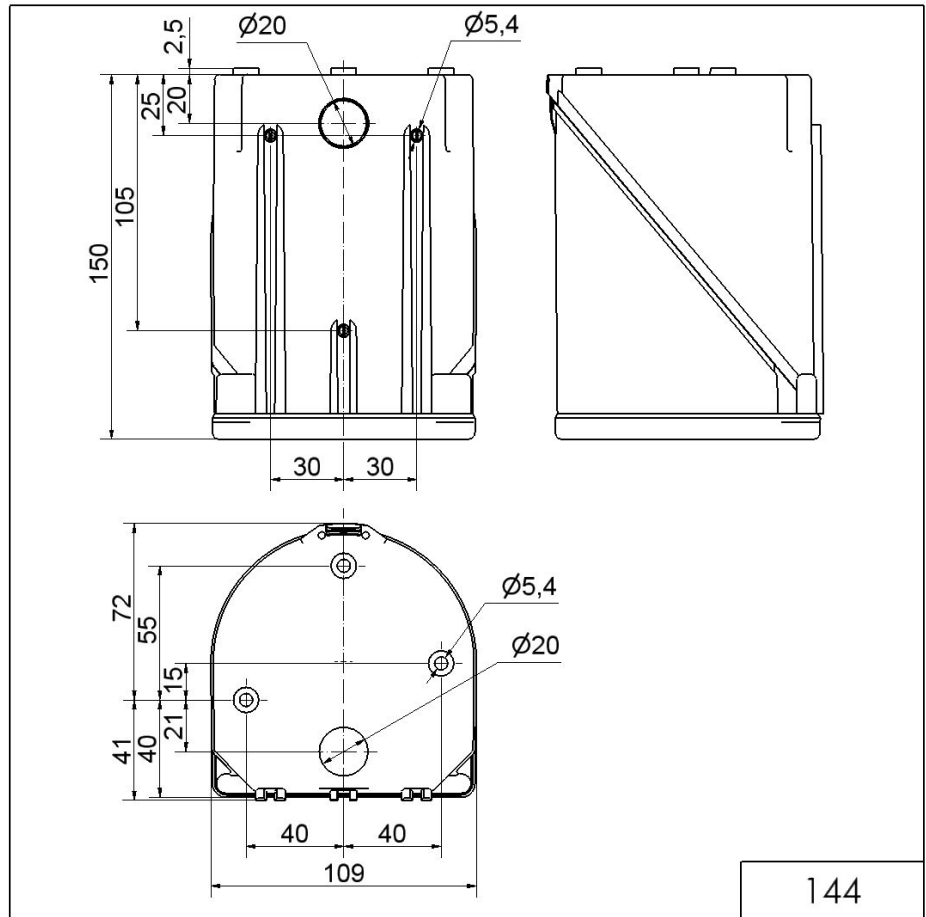

! For additional installation and mounting information, refer to the appropriate user guide at www.werma.com. This printed copy is for information only and is subject to alteration.