

Micro installation beacon / LED Beacon 230

LED Perm. Beacon EM 24VDC YE



Part No.: 230.300.55



MECHANICAL DATA	
Height	154 mm
Diameter	29 mm
Materials	PC PC/ABS
Dome colour	Yellow
Housing colour	Black
Protection category	IP65
Connection	Stranded wires (tinned) Stranded wires with ferrules
Cable length	115 mm
Type of fixing	Built-in mounting
Service life optical	100,000 h maximum
Working temperature minimum	-20°C
Working temperature maximum	+50°C
UL Type Rating	Type 12
Weight with packaging	17 g
Product weight	12 g
ELECTRICAL DATA	
Operating voltage	24V
Operating voltage type	DC
Operating voltage tolerance	+/- 10%
Rated operational voltage	24 VDC
Rated operational current	45 mA
Rated inrush current	500 mA
Protection class	Protection class 2
Pollution degree	3 In the connection area: 2
OPTICAL DATA	
Light source	LED
Light colour	Yellow
Optical signal image	Permanent



For additional installation and mounting information, refer to the appropriate user guide at www.werma.com. This printed copy is for information only and is subject to alteration.

Micro installation beacon / LED Beacon 230

LED Perm. Beacon EM 24VDC YE

DRAWING

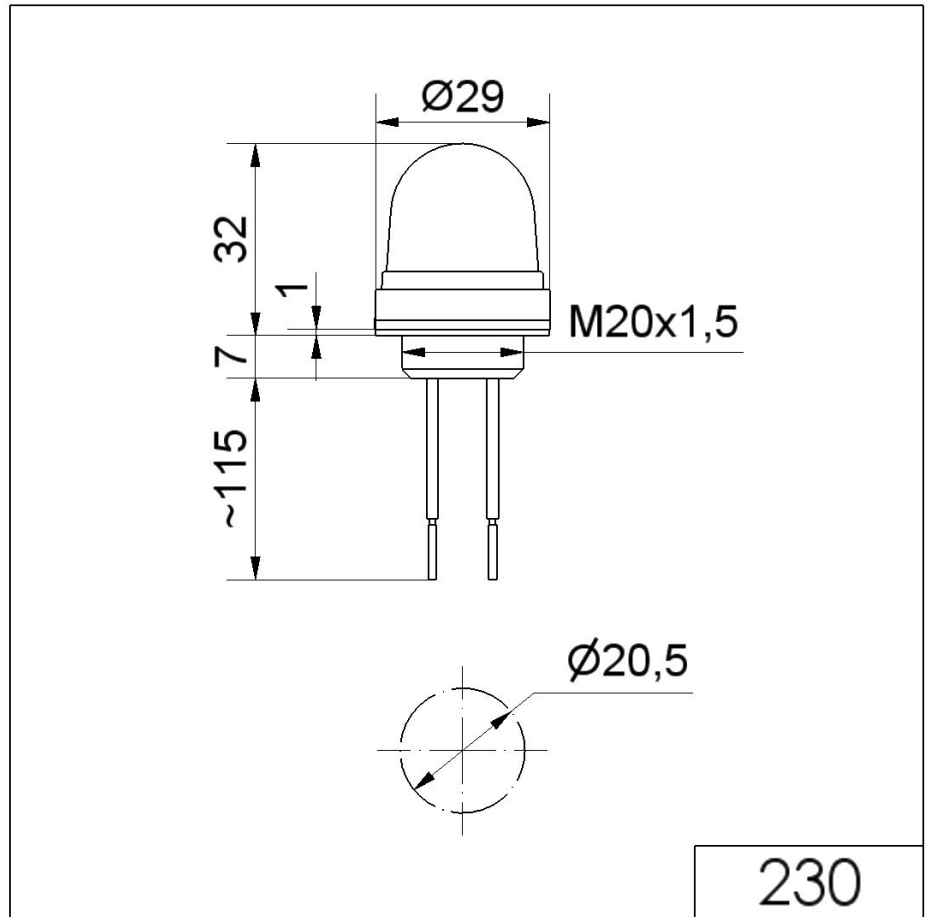

! For additional installation and mounting information, refer to the appropriate user guide at www.werma.com. This printed copy is for information only and is subject to alteration.