

Midi free-standing Beacons / Blinkleuchte 827

Blinking Beacon BM 230VAC/DC YE

Part No.: 827.300.78



MECHANICAL DATA	
Height	137 mm
Diameter	98 mm
Materials	PC PC/ABS
Dome colour	Yellow
Housing colour	Black
Protection category	IP65
Connection	Screw terminals
cross-sectional area maximum	2,50mm ² / 14AWG
Cable entry	Rubber pinch
Cable entry minimum	d = 5 mm
Cable entry maximum	d = 7 mm
Type of fixing	Base mounting
Service life optical	depends on bulb
Working temperature minimum	-20°C
Working temperature maximum	+50°C
UL Type Rating	Type 12
Weight with packaging	258 g
Product weight	207 g
ELECTRICAL DATA	
Operating voltage	230V
Operating voltage type	AC/DC
Operating voltage type	50Hz
Operating voltage tolerance	+/- 10%
Rated operational voltage	230 VAC
Rated operational current	90 mA
Rated inrush current	500 mA
Protection class	Protection class 2
Pollution degree	3
Overvoltage category	II
Isolation voltage	Ui = 250V; Uimp = 2.500V
OPTICAL DATA	
Light colour	Yellow
Blink frequency (Hz)	1.7 Hz



For additional installation and mounting information, refer to the appropriate user guide at www.werma.com. This printed copy is for information only and is subject to alteration.

Midi free-standing Beacons / Blinkleuchte 827
Blinking Beacon BM 230VAC/DC YE

DRAWING

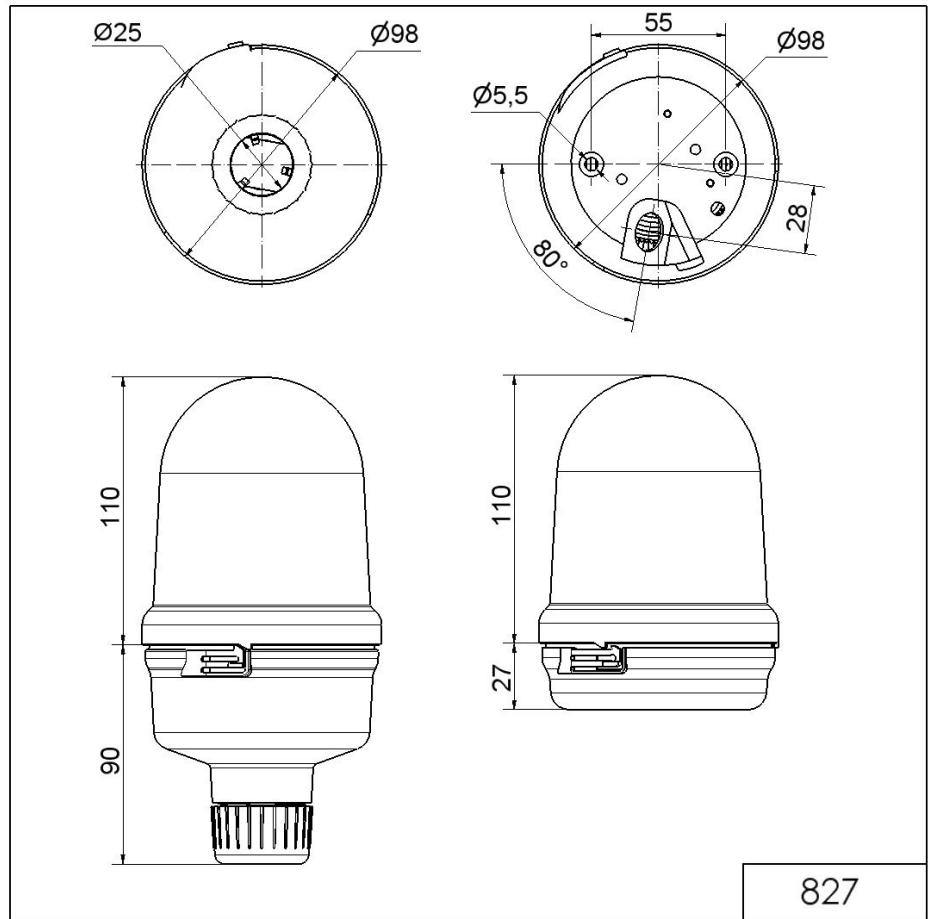

! For additional installation and mounting information, refer to the appropriate user guide at www.werma.com. This printed copy is for information only and is subject to alteration.