



**Model Number**

**V15-W-5M-PVC**

Female cordset, M12, 5-pin, PVC cable

**Features**

- Knurled nut suitable for tool assembly
- Immunity to vibration, with mechanical latching
- Gold plated contacts
- Degree of protection IP67 / IP68 / IP69K
- Suitable for 2-, 3- and 4-wire technology

**Dimensions**

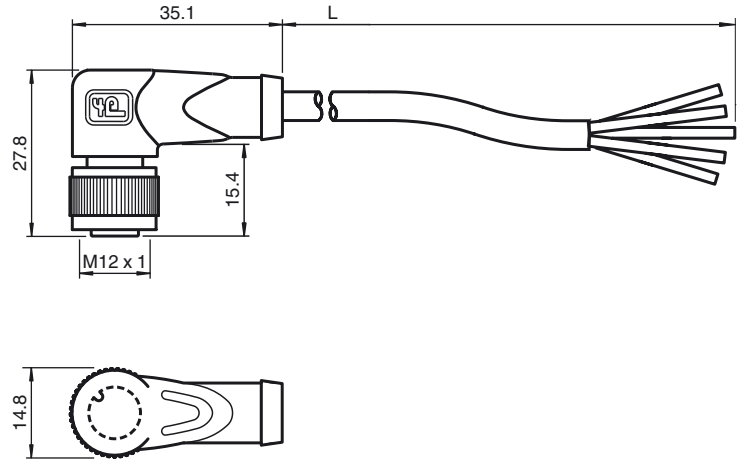

**Technical data**

**General specifications**

Number of pins	5
Connection 1	socket
Construction type 1	right angle
Threading 1	M12
Connection 2	cable end

**Electrical specifications**

Operating voltage	$U_B$	max. 48 V AC / 60 V DC
Operating current	$I_B$	max. 4 A
Volume resistance		< 5 mΩ

**Ambient conditions**

Ambient temperature	Body: -40 ... 90 °C (-40 ... 194 °F) cable, fixed: -25 ... 70 °C (-13 ... 158 °F) cable, flexing: -5 ... 70 °C (23 ... 158 °F)
Pollution degree	3

**Mechanical specifications**

Contact elements	spring-loaded contact socket
Pin diameter	1 mm
Degree of protection	IP67 / IP68 / IP69k
Material	
Contacts	CuSn / Au
Contact surface	Au
Body	TPU, black
Cable	PVC
Slotted nut	Diecast zinc
Core insulation	PVC
Cable	fine-strand, flexible
Sheath diameter	Ø 4.8 mm
Bending radius	> 10 x cable diameter, moving
Color	grey
Number of cores	5
Core cross-section	0.34 mm <sup>2</sup>
Conductor construction	19 x 0.15 mm Ø
Length	L 5 m
Flammability	
Contact carrier	94 HB
Housing	94 V-2

**Compliance with standards and directives**

Standard conformity	
Degree of protection	EN 60529:2000
Standards	IEC 61076-2-101:2008 with test voltage 500 V <sub>DC</sub>
Flammability	Grip: UL 94
Specification	connector M12 x 1 : IEC 61076-2-101

**Electrical connection**

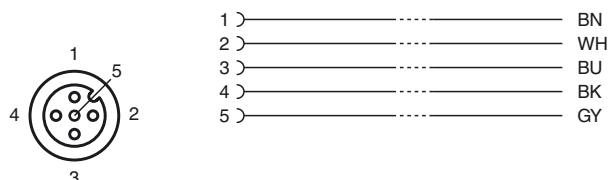

Release date: 2019-07-15 17:12 Date of issue: 2019-07-15 109482\_eng.xml



# SCATTERGOOD & JOHNSON LTD

ELECTRICAL ENGINEERING & FLUID CONTROL DISTRIBUTORS

Est.1899

At Scattergood & Johnson Ltd, we pride ourselves on being a technical distributor to specialist industries.

Working with a range of quality product suppliers across a number of specialist markets, we are not your average 'box shifter' - we are your technical and supply chain partner.

We fully support every product we sell - for free! Our internal team and external sales engineers can answer any product or application question, no matter the complexity.

Backing up this technical ability is a range of 50,000+ products available from stock for nationwide next day delivery (same day if required!), or you can collect what you need from any of our trade counters around the UK.

Select your specialist interest below to learn more about how we can help.



Online, In Branch and On the Road - Scattergood & Johnson Ltd, there when you need us.

# [www.scatts.co.uk](http://www.scatts.co.uk)