



Model Number

V1-W-2M-PVC

Female cordset, M12, 4-pin, PVC cable

Features

- Knurled nut suitable for tool assembly
- Immunity to vibration, with mechanical latching
- Degree of protection IP67 / IP68 / IP69K
- Gold-plated and machined contacts

Dimensions

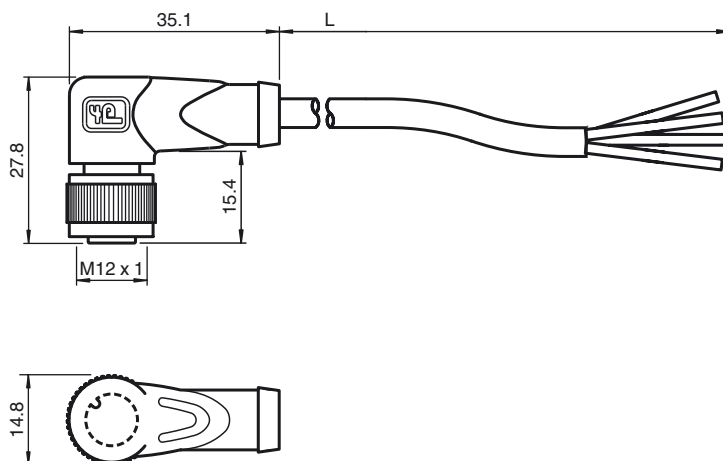

Technical data

General specifications

Number of pins 4

Electrical specifications

Operating voltage U_B max. 250 V AC/DC
 Operating current I_B max. 4 A
 Contact resistance < 10 m Ω

Ambient conditions

Ambient temperature Body: -40 ... 90 °C (-40 ... 194 °F)
 cable, fixed: -25 ... 70 °C (-13 ... 158 °F)
 cable, flexing: -5 ... 70 °C (23 ... 158 °F)

Pollution degree 3

Mechanical specifications

Contact elements spring-loaded contact socket

Pin diameter 1 mm

Degree of protection IP67 / IP68 / IP69k

Material

Contacts CuSn / Au

Contact surface Au

Body TPU, black

Cable PVC

Slotted nut Diecast zinc

Core insulation PVC

Cable fine-strand, flexible

Sheath diameter \varnothing 4.8 mm

Bending radius > 10 x cable diameter, moving

Color grey

Cores 4 x 0.34 mm²

Conductor construction 19 x 0.15 mm \varnothing

Length L 2 m

Flammability

Contact carrier 94 HB

Housing 94 V-2

Cable flame-resistant

Compliance with standards and directives

Standard conformity

Degree of protection EN 60529:2000

Standards IEC 61076-2-101:2008

Electrical connection

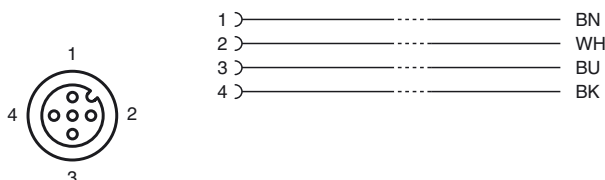



SCATTERGOOD & JOHNSON LTD

ELECTRICAL ENGINEERING & FLUID CONTROL DISTRIBUTORS

Est.1899

At Scattergood & Johnson Ltd, we pride ourselves on being a technical distributor to specialist industries.

Working with a range of quality product suppliers across a number of specialist markets, we are not your average 'box shifter' - we are your technical and supply chain partner.

We fully support every product we sell - for free! Our internal team and external sales engineers can answer any product or application question, no matter the complexity.

Backing up this technical ability is a range of 50,000+ products available from stock for nationwide next day delivery (same day if required!), or you can collect what you need from any of our trade counters around the UK.

Select your specialist interest below to learn more about how we can help.



Online, In Branch and On the Road - Scattergood & Johnson Ltd, there when you need us.

www.scatts.co.uk