

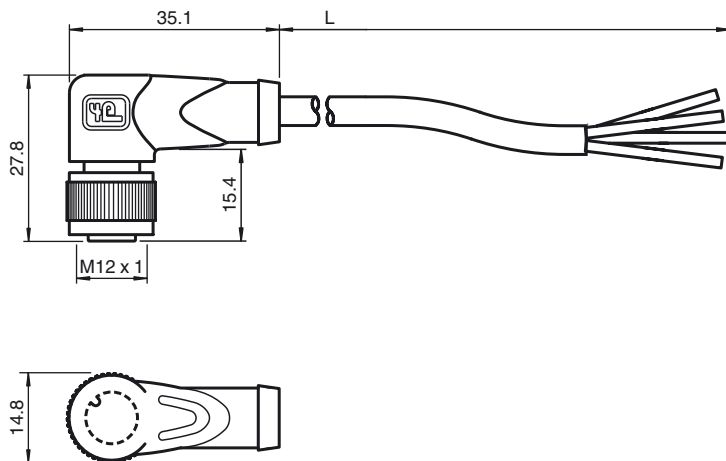

Dimensions



Model Number

V1-W-N4-10M-PUR

Female cordset, M12, 4-pin, NAMUR, PUR cable

Features

- Suitable for NAMUR technology
- Blue body and sheathing
- Knurled nut suitable for tool assembly
- Immunity to vibration, with mechanical latching
- Gold plated contacts
- Degree of protection IP67 / IP68 / IP69K

Technical data

General specifications

Number of pins	4
Connection 1	socket
Construction type 1	right angle
Threading 1	M12
Connection 2	cable end

Electrical specifications

Operating voltage	U_B	max. 250 V AC/DC
Operating current	I_B	max. 4 A
Contact resistance		< 10 mΩ
Inductance		0.55 mH / km
Capacitance		88.3 nF / km

Ambient conditions

Ambient temperature	Body: -40 ... 90 °C (-40 ... 194 °F) cable -25 ... 100 °C (-13 ... 212 °F)
Pollution degree	3

Mechanical specifications

Contact elements	spring-loaded contact socket
Pin diameter	1 mm
Degree of protection	IP67 / IP68 / IP69K
Cable code	Li FY 11Y 4 x 0.34
Material	
Contacts	CuSn / Au
Contact surface	Au
Body	TPU, black
Cable	PUR
Slotted nut	Diecast zinc
Core insulation	PVC
Cable	extra-fine wire, flexible
Sheath diameter	Ø4.8 mm
Bending radius	> 15 x cable diameter, moving > 10 x cable diameter, fixed
Color	blue
Cores	4 x 0.34 mm ²
Conductor construction	42 x 0.1 mm Ø
Length	L 10 m
Flammability	
Contact carrier	94 HB
Housing	94 V-2

Compliance with standards and directives

Standard conformity	
---------------------	--

Electrical connection

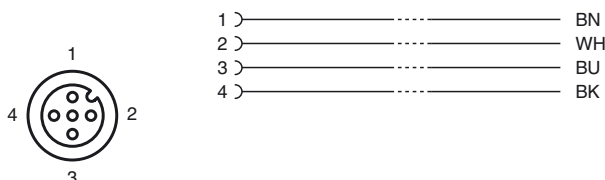

Release date: 2019-05-14 15:17 Date of issue: 2019-05-14 132434_eng.xml



Degree of protection	EN 60529
Standards	IEC 61076-2-101



SCATTERGOOD & JOHNSON LTD

ELECTRICAL ENGINEERING & FLUID CONTROL DISTRIBUTORS

Est.1899

At Scattergood & Johnson Ltd, we pride ourselves on being a technical distributor to specialist industries.

Working with a range of quality product suppliers across a number of specialist markets, we are not your average 'box shifter' - we are your technical and supply chain partner.

We fully support every product we sell - for free! Our internal team and external sales engineers can answer any product or application question, no matter the complexity.

Backing up this technical ability is a range of 50,000+ products available from stock for nationwide next day delivery (same day if required!), or you can collect what you need from any of our trade counters around the UK.

Select your specialist interest below to learn more about how we can help.



Online, In Branch and On the Road - Scattergood & Johnson Ltd, there when you need us.

www.scatts.co.uk