



Model Number

NBN15-18GM60-UO

Features

- Cylindrical
- 15 mm non-flush
- 2-wire AC/DC

Accessories

BF 18

Mounting flange, 18 mm

Technical Data

General specifications

Switching function	Normally closed (NC)
Output type	Two-wire
Rated operating distance	s_n 15 mm
Installation	non-flush
Output polarity	AC/DC
Reduction factor r_{Al}	0.45
Reduction factor r_{Cu}	0.4
Reduction factor r_{304}	0.7
Output type	3-wire

Nominal ratings

Operating voltage	U_B	20 ... 250 V AC/20 ... 300 V DC
Switching frequency	f	30 Hz
Hysteresis	H	3 ... 15 typ. 5 %
Reverse polarity protection		yes
Short-circuit protection		yes
Voltage drop	U_d	≤ 8 V
Operating current	I_L	4 ... 300 mA AC/DC
Off-state current	I_r	≤ 0.8 mA
Operating voltage indicator		LED, green
Switching state indicator		LED, yellow

Ambient conditions

Ambient temperature	-25 ... 70 °C (-13 ... 158 °F)
Storage temperature	-40 ... 85 °C (-40 ... 185 °F)

Mechanical specifications

Connection type	cable PUR , 2 m
Core cross-section	0.5 mm ²
Housing material	brass, nickel-plated
Sensing face	PBT
Degree of protection	IP67

Compliance with standards and directives

Standard conformity	
Standards	EN 60947-5-2:2007 EN 60947-5-2/A1:2012 IEC 60947-5-2:2007 IEC 60947-5-2 AMD 1:2012

Approvals and certificates

UL approval	cULus Listed, General Purpose
CSA approval	cCSAus Listed, General Purpose
CCC approval	Certified by China Compulsory Certification (CCC)

Dimensions

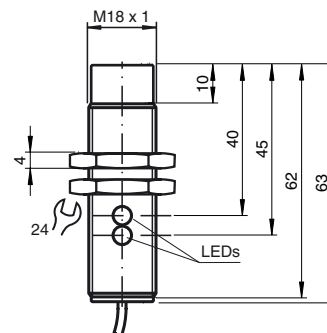

Electrical Connection

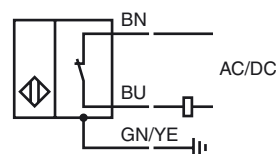



SCATTERGOOD & JOHNSON LTD

ELECTRICAL ENGINEERING & FLUID CONTROL DISTRIBUTORS

Est.1899

At Scattergood & Johnson Ltd, we pride ourselves on being a technical distributor to specialist industries.

Working with a range of quality product suppliers across a number of specialist markets, we are not your average 'box shifter' - we are your technical and supply chain partner.

We fully support every product we sell - for free! Our internal team and external sales engineers can answer any product or application question, no matter the complexity.

Backing up this technical ability is a range of 50,000+ products available from stock for nationwide next day delivery (same day if required!), or you can collect what you need from any of our trade counters around the UK.

Select your specialist interest below to learn more about how we can help.



Online, In Branch and On the Road - Scattergood & Johnson Ltd, there when you need us.

www.scatts.co.uk