



Model Number

GLV18-8-450/73/120

Diffuse mode sensor
with 4-pin, M12 x 1 plastic connector

Features

- Efficient Line in a short M18 plastic housing for standard applications
- Very high detection range
- 4 LEDs indicator for 360° visibility
- Optimized potentiometer design for a clear control button layout in the application
- Version with front optical face
- DC voltage version

Product information

The GLV/GLK18 series sensors help improve the efficiency of machines and systems. The design of the M18 plastic housing, the connection technology, and sensor properties are highly standardized. Concentrating on the key sensor requirements has produced a robust and reliable product series for DC and AC/DC voltage systems without any over-engineering. The mounting set included in the scope of delivery and the optimized potentiometer design ensure fast assembly and easy configuration.

Release date: 2019-11-29 14:44 Date of issue: 2019-11-29 188567_eng.xml

Dimensions

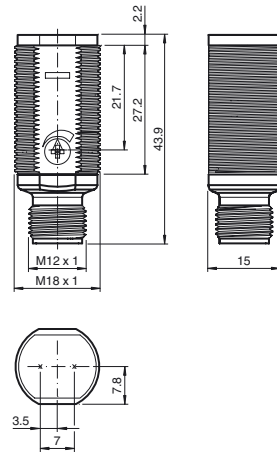

Electrical connection

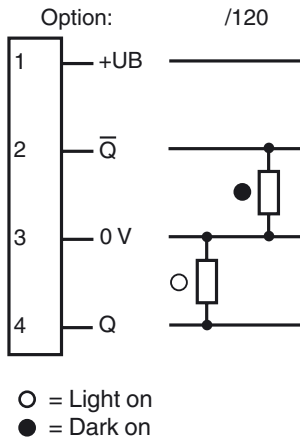

Pinout

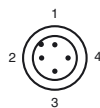

Wire colors in accordance with EN 60947-5-2

1	BN	(brown)
2	WH	(white)
3	BU	(blue)
4	BK	(black)

Indicators/operating means

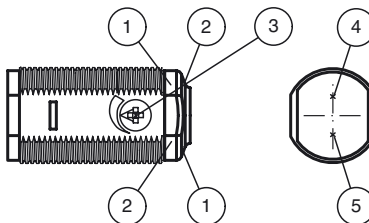

1	Operating display	green
2	Signal display	yellow
3	Sensitivity adjustment	
4	Emitter	
5	Receiver	

Technical data**General specifications**

Detection range	50 ... 450 mm adjustable
Detection range max.	0 ... 450 mm
Reference target	100 mm x 100 mm Kodak white
Light source	LED
Light type	modulated visible red light , 640 nm
Diameter of the light spot	approx. 30 mm at 400 mm
Angle of divergence	approx. 4 °
Optical face	frontal
Ambient light limit	30000 Lux
Hysteresis	H < 15 %

Functional safety related parameters

MTTF _d	920 a
Mission Time (T _M)	20 a
Diagnostic Coverage (DC)	0 %

Indicators/operating means

Operation indicator	LED green, statically lit Power on
Function indicator	LED yellow: lights when object is detected ; flashes when falling short of the stability control
Control elements	sensitivity adjustment

Electrical specifications

Operating voltage	U _B	10 ... 30 V DC
No-load supply current	I ₀	< 20 mA

Output

Switching type	light/dark on	
Signal output	2 PNP, complementary, short-circuit protected, open collectors	
Switching voltage	max. 30 V DC	
Switching current	max. 100 mA	
Voltage drop	U _d	≤ 1.5 V DC
Switching frequency	f	500 Hz
Response time		≤ 1 ms

Conformity

Product standard	EN 60947-5-2
------------------	--------------

Ambient conditions

Ambient temperature	-25 ... 60 °C (-13 ... 140 °F)
Storage temperature	-40 ... 70 °C (-40 ... 158 °F)

Mechanical specifications

Degree of protection	IP67
Connection	4-pin, M12 x 1 connector
Material	
Housing	PC
Optical face	PMMA
Connector	plastic
Mass	approx. 10 g

Approvals and certificates

EAC conformity	TR CU 020/2011
Protection class	II, rated insulation voltage ≤ 250 V AC with pollution degree 1-2 according to IEC 60664-1
UL approval	cULus Listed, Class 2 Power Source
CCC approval	CCC approval / marking not required for products rated ≤36 V

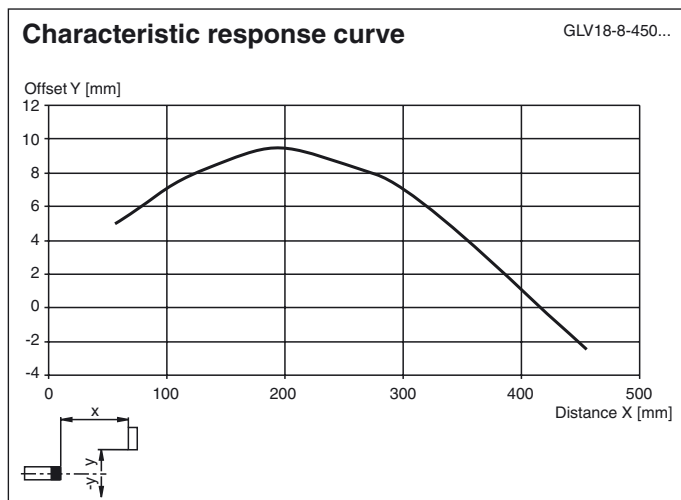
Curves/Diagrams**Accessories****CPZ18B03**

Mounting Bracket with swivel nut

BF 18

Mounting flange, 18 mm

BF 18-F

Plastic mounting adapter, 18 mm

BF 5-30

Universal mounting bracket for cylindrical sensors with a diameter of 5 ... 30 mm

V1-G-2M-PUR

Female cordset, M12, 4-pin, PUR cable

V1-W-2M-PUR

Female cordset, M12, 4-pin, PUR cable

Other suitable accessories can be found at www.pepperl-fuchs.com

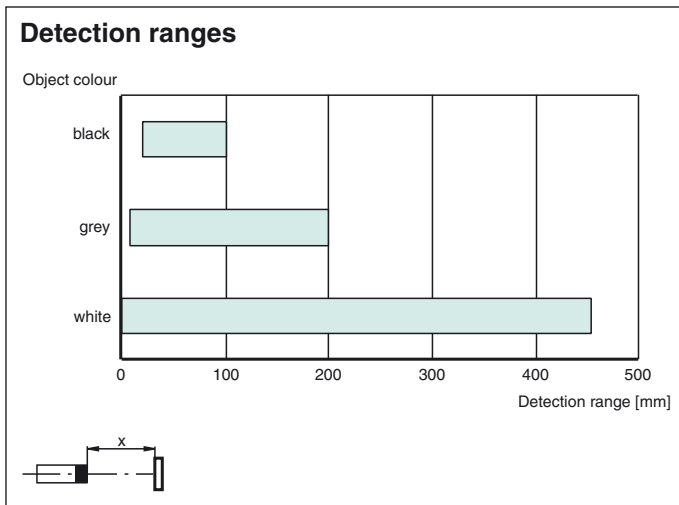
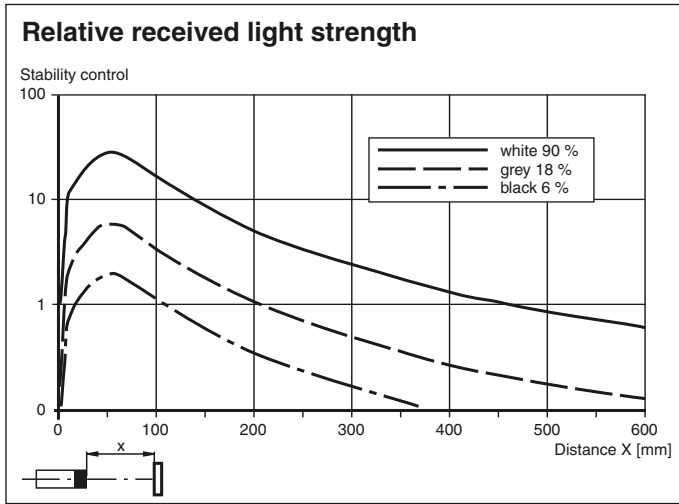

Release date: 2019-11-29 14:44 Date of issue: 2019-11-29 188567_eng.xml



SCATTERGOOD & JOHNSON LTD

ELECTRICAL ENGINEERING & FLUID CONTROL DISTRIBUTORS

Est.1899

At Scattergood & Johnson Ltd, we pride ourselves on being a technical distributor to specialist industries.

Working with a range of quality product suppliers across a number of specialist markets, we are not your average 'box shifter' - we are your technical and supply chain partner.

We fully support every product we sell - for free! Our internal team and external sales engineers can answer any product or application question, no matter the complexity.

Backing up this technical ability is a range of 50,000+ products available from stock for nationwide next day delivery (same day if required!), or you can collect what you need from any of our trade counters around the UK.

Select your specialist interest below to learn more about how we can help.



Online, In Branch and On the Road - Scattergood & Johnson Ltd, there when you need us.

www.scatts.co.uk