

Features

- 1-channel signal conditioner
- 24 V DC supply (Power Rail)
- Current and voltage input
- 2 relay contact outputs
- Programmable high/low alarm
- Configurable via DIP switches and potentiometer
- Terminal blocks with test sockets

Function

This signal conditioner provides the galvanic isolation between field circuits and control circuits.

The device is a trip amplifier with two trip points. Trip points, hysteresis and mode of operation can be set independently for both relay outputs.

0/4 mA ... 20 mA-, 0/1 V ... 5 V- or 0/2 V ... 10 V signals can be connected at the input.

The device actuates the relay output when it reaches the adjusted trip points.

The device is easily configured by the use of DIP switches and potentiometers.

Assembly

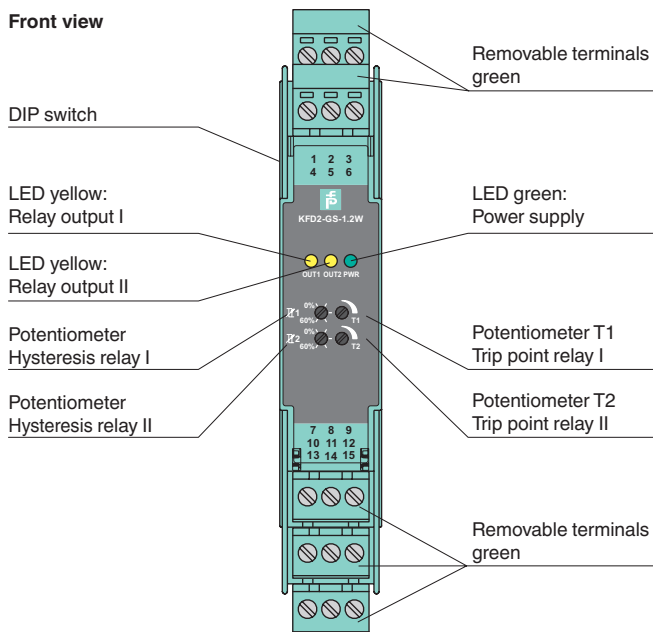

Connection

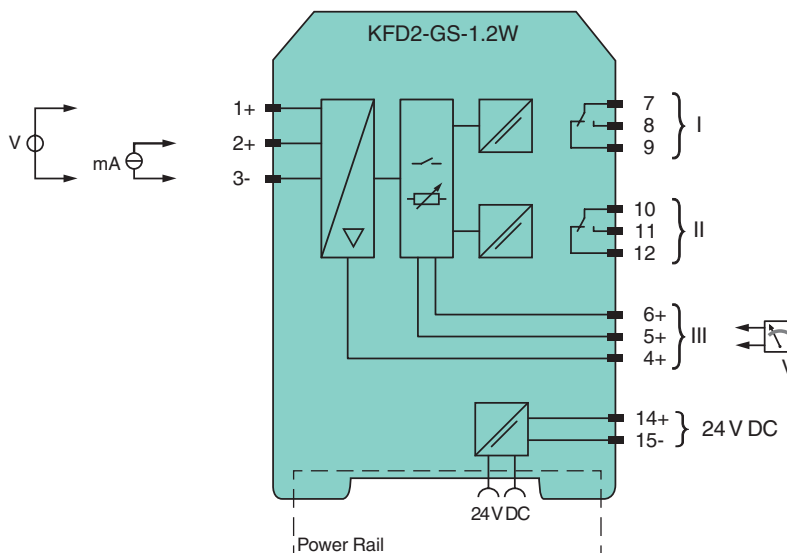

Release date 2019-04-09 12:59 Date of issue 2019-10-09 292461_eng.xml

Refer to "General Notes Relating to Pepperl+Fuchs Product Information".

General specifications		
Signal type		Analog input
Supply		
Connection		Power Rail or terminals 14+, 15-
Rated voltage	U_r	20 ... 30 V DC
Rated current	I_r	< 50 mA
Power consumption		< 1.5 W
Input		
Connection side		field side
Measurement range		terminals 1+, 3-: voltage 0/1 ... 5 V, load $\geq 50 \text{ k}\Omega$ or voltage 0/2 ... 10 V, load $\geq 100 \text{ k}\Omega$ terminals 2+, 3-: current 0/4 ... 20 mA ; load $\leq 50 \Omega$
Output		
Connection side		control side
Output I, II		terminals 7, 8, 9; 10, 11, 12
Contact loading		250 V AC / 4 A / $\cos \phi > 0.7$; 40 V DC / 2 A resistive load
Output III		device configuration : terminals 4, 5, 6
Transfer characteristics		
Deviation		$\leq 1 \%$
Influence of ambient temperature		0.01 % / K of adjusted trip value
Input delay		200 ms
Galvanic isolation		
Input/power supply		reinforced insulation according to IEC/EN 61010-1, rated insulation voltage 300 V _{eff}
Input/output I, II		reinforced insulation according to IEC/EN 61010-1, rated insulation voltage 300 V _{eff}
Output I, II/power supply		reinforced insulation according to IEC/EN 61010-1, rated insulation voltage 300 V _{eff}
Indicators/settings		
Display elements		LEDs
Control elements		DIP-switch potentiometer
Configuration		via DIP switches via potentiometer
Labeling		space for labeling at the front
Directive conformity		
Electromagnetic compatibility		
Directive 2014/30/EU		EN 61326-1:2013 (industrial locations)
Low voltage		
Directive 2014/35/EU		EN 61010-1:2010
Conformity		
Degree of protection		IEC 60529
Protection against electrical shock		EN 61010-1:2010
Ambient conditions		
Ambient temperature		-20 ... 60 °C (-4 ... 140 °F)
Mechanical specifications		
Degree of protection		IP20
Connection		screw terminals
Mass		approx. 120 g
Dimensions		20 x 124 x 115 mm (0.8 x 4.9 x 4.5 inch) , housing type B2
Mounting		on 35 mm DIN mounting rail acc. to EN 60715:2001
General information		
Supplementary information		Observe the certificates, declarations of conformity, instruction manuals, and manuals where applicable. For information see www.pepperl-fuchs.com .
Accessories		
Optional accessories		- power feed module KFD2-EB2(.R4A.B)(.SP) - universal power rail UPR-03(-M)(-S) - profile rail K-DUCT-GY(-UPR-03)

Release date 2019-04-09 12:59 Date of issue 2019-10-09 292461_eng.xml

Function

Internal signal voltage

The device converts the input signals at terminals 1, 2, and 3 into a proportional internal voltage U_{int} between 0 V and 10 V. This conversion allows reaction-free verification of the input signal. The voltage is output at terminals 4+ and 3-.

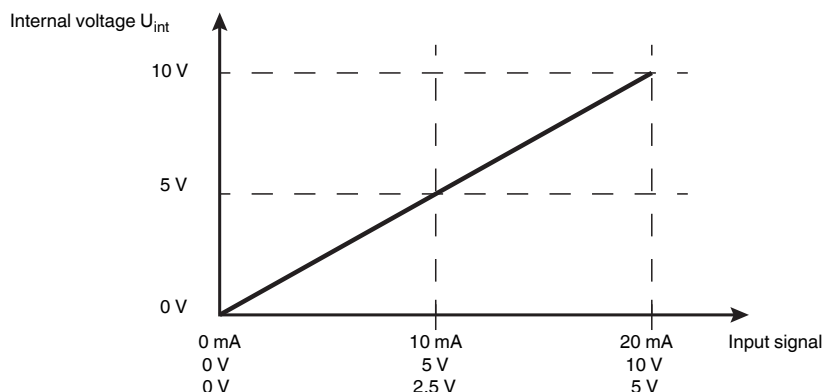

Trip points

The potentiometers T1 and T2 convert the set trip points into a proportional switching voltage U_{pot} between 0 V and 10 V. The voltage range corresponds to a range of 0 % to 100 %. This voltage can be measured at terminals 3, 5, and 6.

- Relay output I: Terminals 5+, 3-
- Relay output II: Terminals 6+, 3-

The trip point, hysteresis, mode of operation and type of alarm (high or low alarm) can be selected for each relay.

High alarm means that the switching state of the relay changes when the set trip point is exceeded. This state comes to an end if the value falls below a lower limit. The difference between these two values corresponds to the hysteresis, which can be set on the front panel. With a low alarm, the alarm signal is output at values below the trip point.

High alarm/relay energized

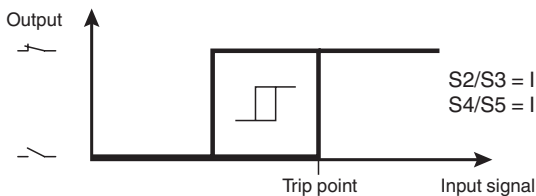

High alarm/relay de-energized

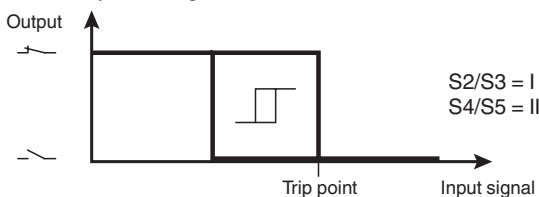

Low alarm/relay energized

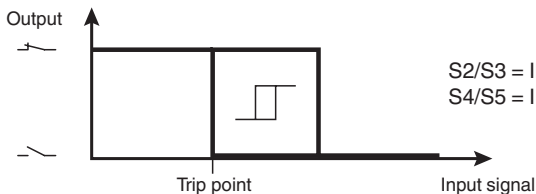

Low alarm/relay de-energized

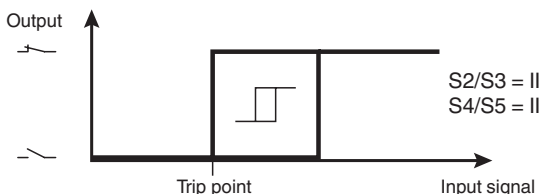

Release date 2019-04-09 12:59 Date of issue 2019-10-09 292461_eng.xml

Refer to "General Notes Relating to Pepperl+Fuchs Product Information".

Configuration

DIP switch function

Set the DIP switch according to the required function.

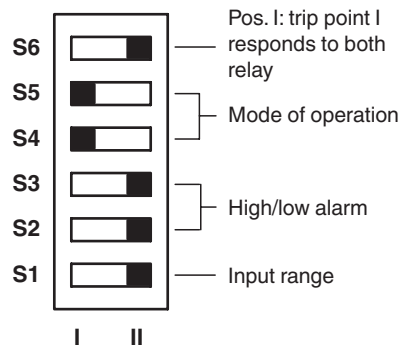

Switch	Position	Function
S6	I	Trip point I addresses both relay
	II	Relay I independent of relay II
S5	I	Relay II energized in case of alarm
	II	Relay II de-energized in case of alarm
S4	I	Relay I energized in case of alarm
	II	Relay I de-energized in case of alarm
S3	I	High alarm relay II
	II	Low alarm relay II
S2	I	High alarm relay I
	II	Low alarm relay I
S1	I	Input ranges 0/1 V to 5 V or 0/4 mA to 20 mA
	II	Input ranges 0/2 V to 10 V or 0/4 mA to 20 mA

Setting the trip points with no input signal

The trip points can be set using the potentiometers T1 and T2 and the proportional switching voltage U_{pot} at terminals 5+, 3- (relay I) and terminals 6+, 3- (relay II). This is done using a voltage meter (measuring range 10 V). There must be no input signal at this point. Select the trip points in the unit of the input signal or in %.

Input signal in mA, trip point TP in mA

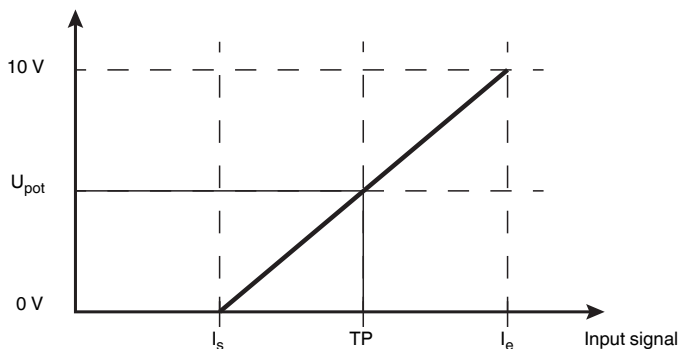

I_s = Starting point
 TP = Trip point
 I_e = End point
 U_{pot} = Proportional switching voltage

The proportional switching voltage U_{pot} is calculated using the following formula:

$$U_{pot} = 10 \text{ V} \times (TP - I_s) / (I_e - I_s)$$

Example:

Trip point TP: 13 mA
 I_s : 4 mA
 I_e : 20 mA

$$U_{pot} = 10 \text{ V} \times (13 \text{ mA} - 4 \text{ mA}) / (20 \text{ mA} - 4 \text{ mA}) = 5.6 \text{ V}$$

Input signal in mA, trip point TP in %

The proportional switching voltage U_{pot} is calculated using the following formula:

$$U_{pot} = 1 \text{ V} / 2 \text{ mA} \times (TP / 100 \times (I_e - I_s) + I_s)$$

Example:

Trip point TP: 75 %
 I_s : 4 mA
 I_e : 20 mA

$$U_{pot} = 1 \text{ V} / 2 \text{ mA} \times (75 \% / 100 \% \times (20 \text{ mA} - 4 \text{ mA}) + 4 \text{ mA}) = 8 \text{ V}$$

Release date 2019-04-09 12:59 Date of issue 2019-10-09 292461_eng.xml

Input signal in V, trip point TP in V

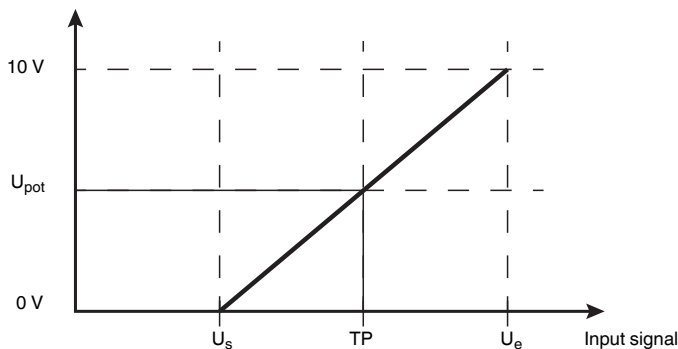

U_s = Starting point
 TP = Trip point
 U_e = End point
 U_{pot} = Proportional switching voltage

The proportional switching voltage U_{pot} is calculated using the following formula:

$$U_{pot} = 10 \text{ V} \times (TP - U_s) / (U_e - U_s)$$

Example:

Trip point TP: 7 V
 U_s: 2 V
 U_e: 10 V
 $U_{pot} = 10 \text{ V} \times (7 \text{ V} - 2 \text{ V}) / (10 \text{ V} - 2 \text{ V}) = 6.25 \text{ V}$

Input signal in V, trip point TP in %

The proportional switching voltage U_{pot} is calculated using the following formula:

$$U_{pot} = TP / 100 \times (U_e - U_s) + U_s$$

Example:

Trip point TP: 45 %
 U_s: 2 V
 U_e: 10 V
 $U_{pot} = 45 \% / 100 \% \times (10 \text{ V} - 2 \text{ V}) + 2 \text{ V} = 5.6 \text{ V}$

Setting the trip points with an input signal

The trip points can be adjusted to the input signal using potentiometers T1 and T2. No measuring device is required.

For low alarm:

1. Turn the potentiometer counterclockwise as far as it will go to the left (15 turns).
2. Turn the potentiometer clockwise until the output is tripped. Each turn changes the trip point by about 7 %.
3. Set the hysteresis. This does not change the trip point.

For high alarm:

1. Turn the potentiometer clockwise as far as it will go to the right (15 turns)
2. Turn the potentiometer counterclockwise until the output is tripped. Each turn changes the trip point by around 7 %.
3. Set the hysteresis. This does not change the trip point.

Release date 2019-04-09 12:59 Date of issue 2019-10-09 292461_eng.xml

Refer to "General Notes Relating to Pepperl+Fuchs Product Information".



SCATTERGOOD & JOHNSON LTD

ELECTRICAL ENGINEERING & FLUID CONTROL DISTRIBUTORS

Est.1899

At Scattergood & Johnson Ltd, we pride ourselves on being a technical distributor to specialist industries.

Working with a range of quality product suppliers across a number of specialist markets, we are not your average 'box shifter' - we are your technical and supply chain partner.

We fully support every product we sell - for free! Our internal team and external sales engineers can answer any product or application question, no matter the complexity.

Backing up this technical ability is a range of 50,000+ products available from stock for nationwide next day delivery (same day if required!), or you can collect what you need from any of our trade counters around the UK.

Select your specialist interest below to learn more about how we can help.



Online, In Branch and On the Road - Scattergood & Johnson Ltd, there when you need us.

www.scatts.co.uk