

MANUAL

**UNIVERSAL SIGNAL CONDITIONER  
FOR VOLTAGE AND CURRENT  
KF\*\*-USC-1.D**

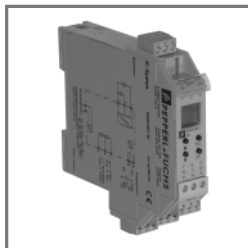

With regard to the supply of products, the current issue of the following document is applicable:  
The general terms of delivery for products and services of the electrical industry, as published by  
the central association of the "Elektrotechnik und Elektroindustrie (ZVEI) e.V.",  
including the supplementary clause "Extended reservation of title".

<b>1</b>	<b>Symbols used</b> .....	<b>3</b>
<b>2</b>	<b>Overview</b> .....	<b>4</b>
<b>2.1</b>	<b>Range of application</b> .....	<b>4</b>
<b>2.2</b>	<b>Versions</b> .....	<b>4</b>
<b>3</b>	<b>Safety instructions</b> .....	<b>5</b>
<b>4</b>	<b>Installation and Connection</b> .....	<b>6</b>
<b>4.1</b>	<b>Installation</b> .....	<b>6</b>
<b>4.2</b>	<b>Connection</b> .....	<b>7</b>
<b>4.3</b>	<b>Front panel</b> .....	<b>8</b>
<b>5</b>	<b>Display mode and error messages</b> .....	<b>9</b>
<b>6</b>	<b>Editing device data</b> .....	<b>10</b>
<b>6.1</b>	<b>Parametrisation mode</b> .....	<b>10</b>
6.1.1	Invocation .....	10
6.1.2	Password .....	11
6.1.3	Navigation method .....	12
6.1.4	Lowest menu level: choose values, enter numbers .....	13
<b>6.2</b>	<b>Unit</b> .....	<b>14</b>
<b>6.3</b>	<b>Input</b> .....	<b>15</b>
6.3.1	Zero and Factor .....	16
6.3.2	Line Monitor .....	16
6.3.3	Smoothing .....	16
<b>6.4</b>	<b>Relay</b> .....	<b>17</b>
6.4.1	Operating behaviour .....	18
6.4.2	Trip and hysteresis .....	19
6.4.3	Alarm Freeze .....	19
6.4.4	Delay .....	20

<b>6.5</b>	<b>Analogue Out.</b> .....	<b>21</b>
6.5.1	Characteristic .....	23
6.5.2	Examples for representations of the input signal in the output signal .....	24
6.5.3	Start and end values .....	25
6.5.4	Fault Out .....	26
<b>6.6</b>	<b>Service</b> .....	<b>27</b>
<b>6.7</b>	<b>Factory settings</b> .....	<b>28</b>
<b>7</b>	<b>Example level measurement</b> .....	<b>29</b>
7.1	Input parameters and unit .....	30
7.2	Output parameters .....	31

## 1 Symbols used



Warning

*This symbol warns of possible danger.  
Failure to heed this warning may result in personal injury or death, or property damage, including destruction.*



Attention

*This symbol warns the user of a possible failure.  
Failure to heed this warning can lead to total failure of the equipment and any other connected equipment.*



Note

*This symbol alerts the user of an important hint.*

## 2 Overview

### 2.1 Range of application

The K-system devices from Pepperl+Fuchs are used for transmitting signals between the field devices and the process control system/control system.

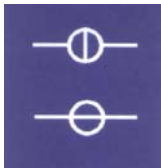

At the input of the universal signal conditioner KF\*\*-USC-1.D (short: USC) current sources (in the range 0 mA ... 20 mA) or voltage sources (in the range 0 mV ... 60 mV or 0 V ... 10 V) can be connected.

The USC converts a freely parameterizable part of the input signal into a proportional output current (0/4 mA ... 20 mA) or into a proportional output voltage (0/1 V ... 5 V or 0/2 V ... 10 V).

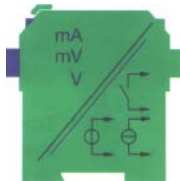

This output signal can be transmitted to e. g. a display device or an analog input of the process control system/the control. Via the relay output of the USC a freely parameterizable limit value of the input signal can be monitored.

Further information (e. g. the USC data sheet and the operating instructions for the K-system) can be found on our website [www.pepperl-fuchs.com](http://www.pepperl-fuchs.com) (under product search, enter: \*USC\*).

### 2.2 Versions

The following versions of the universal signal converter are available:

KF\*\*-USC-1.D



D2 = with power supply for 24 V DC (green cover on output side); for power supply via Power Rail with collective error messages, see data sheet and operating instructions for the K-system on our website [www.pepperl-fuchs.com](http://www.pepperl-fuchs.com) (under product search, enter: \*USC\*).

U8 = with omnivoltage power pack, which allows a power supply with 20 V DC ... 90 V DC and 48 V AC ... 253 V AC without switchover and without consideration of the polarity (grey cover on output side).

### 3 Safety instructions



Warning

*The universal signal conditioner KF\*\*-USC-1.D may only be operated by trained professionals in a manner corresponding to this operation manual.*



Warning

*The protection of operating personnel and of the system is only ensured if the devices are used in accordance with their intended purpose. Any other type of operation than that described in this manual places the safety and functionality of the devices and systems connected to them in question.*



Warning

*These devices should only be installed, connected, and configured by trained electricians. The Universal signal conditioner for voltage and current KF\*\*-USC-1.D is **not** suitable for connection to field devices in explosive areas. The field current circuit of the signal converter is **not** intrinsically safe. It must **not** be routed through an explosive area.*



Warning

*If malfunctions cannot be eliminated, the devices must be taken out of operation and protected from being placed in service again inadvertently. Devices must only be repaired directly by the manufacturer Pepperl+Fuchs. Tampering with or making changes to the devices is dangerous and therefore not permitted. They render the warranty void.*



Note

*The responsibility for the adherence to local safety standards lies with the operator.*

## 4 Installation and Connection

### 4.1 Installation



Attention

*The universal signal conditioner KF\*\*-USC-1.D is installed in protection class IP20 and must therefore be protected from adverse environmental conditions (water, small foreign bodies).*

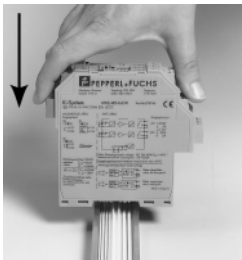

The K-system devices by Pepperl+Fuchs, including the universal signal conditioner KF\*\*-USC-1.D can be mounted on a 35 mm standard rail corresponding to DIN EN 50022. Simply snap on the devices **vertically**, never tipped or angled from the side.

Further mounting alternatives, e. g. using the Power Rail, can be found in the operating instructions for the K-system on our website [www.pepperl-fuchs.com](http://www.pepperl-fuchs.com) (under product search, enter: \*USC\*).

Dimensions of the  
KF\*\*-USC-1.D in mm

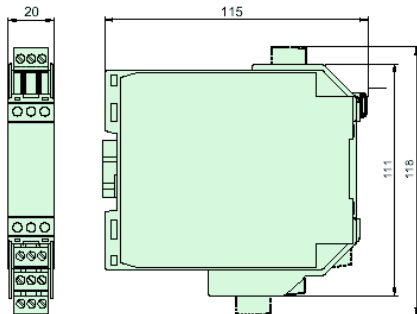

## 4.2 Connection

The detachable clamps of the KF-series considerably simplify the connection and the switch cabinet assembly. They make it possible to replace devices quickly and without error if a customer service becomes necessary.

Terminals are equipped with screws, are self-opening, have a large connection area for a wire cross-section up to 2.5 mm<sup>2</sup> and coded plugs, making it impossible to mix them up.



Terminals 1 ... 3 of the KF\*\*-USC-1.D are used for the field current circuit connection.

You can connect:

- a current source in the range 0 ... 20 mA (terminals 2 and 3)
- a voltage source in the range 0 ... 60 mV or 0 ... 10 V (terminals 1 and 3)

The remaining terminals have the following functions:

- Terminals 7/8: analogue output current signal in the range 0/4 mA ... 20 mA, voltage signal in the range 0/2 V ... 10 V or 0/1 V ... 5 V
- Terminals 10 ... 12: relay
- Terminals 14/15: power supply

The terminals 4 to 6 and 13 are not used in the USC.

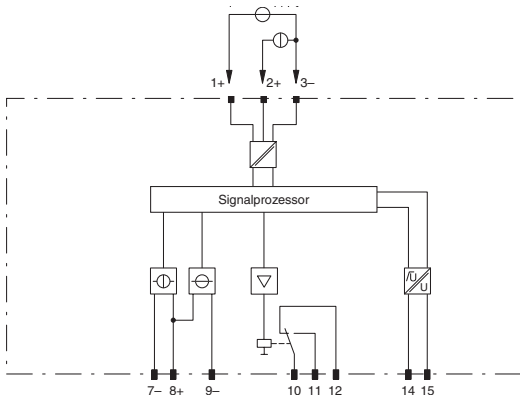

Further details on connecting the USC (e. g. using the Power Rail) can be found in the data sheet and in the operating instructions for the K-system on our website [www.pepperl-fuchs.com](http://www.pepperl-fuchs.com) (under product search, enter: \*USC\*).

### 4.3 Front panel

On the front panel of the USC you will find:

- a display for measured value and error message display and for display during parameterisation mode
- four keys for parameterisation of the USC  
 ▲ (Up)      ▼ (Down)      ESC (Escape)      OK

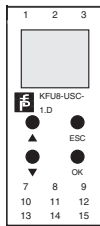

## 5 Display mode and error messages

In normal operation, the display shows the current measurement value in the selected units. To select units, see section 6.2.

If reset blocking (see section 6.4.3) is triggered but the device is still in normal operation, the second line of the display will show a corresponding message.

If a fault occurs, one of the following messages is displayed until the fault is corrected (as long as this is configured):

- *Err Device error*
- *Err LB* for a lead breakage
- *Err SC* for a short circuit

For a list of the fault messages see section 6.3.2.

If you cannot solve the problem by checking the lines and by switching the USC off/on, please contact Pepperl+Fuchs.

The relay always enters a powerless state when a fault occurs.

For information on the behavior of the analogue output in the case of a fault, see section 6.5.4.

## 6 Editing device data



Warning

*A change in device data will change the operation of the device!  
Before entering new data into the device, you should therefore as certain that no  
danger to the installation will result.*

### 6.1 Parametrisation mode

#### 6.1.1 Invocation

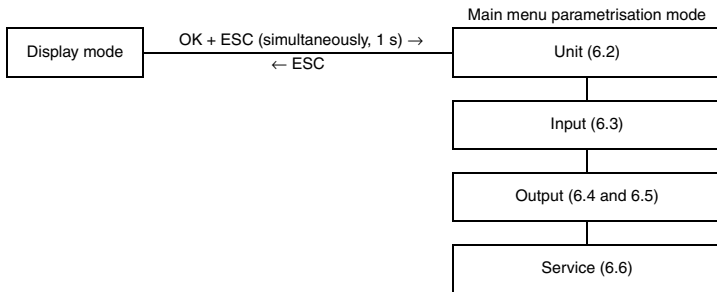

You can return to display mode from any point in the menu in parameterisation mode by pressing the ESC key (possibly multiple times). If you do not press any key for 10 minutes in parameterisation mode, the device automatically switches back into display mode.

### 6.1.2 Password

You can protect the parameterisation from unauthorised changes by means of a password (see section 6.6; inactive when USC delivered).

If password protection is active, the various settings in parameterisation mode can be viewed without entering the password, but not changed. On the first attempt to make a change, the device immediately prompts for a password.

The password must be entered for **each** transition from display mode to parameterisation mode, **once** each time.

The password cannot be changed and is **1234**.

The password is entered as follows:

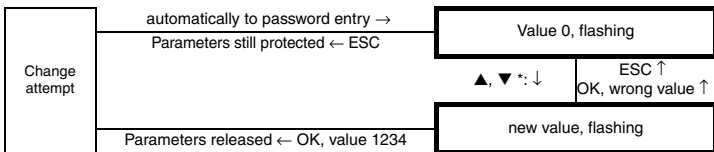

\* If the ▲ or ▼ keys are pressed, the value changes stepwise; if the ▲ or ▼ keys are held down for a longer period, the value "rolls" to higher or lower values.

### 6.1.3 Navigation method

The following diagram illustrates navigation in the parametrisation mode using the ▲, ▼, OK, and ESC keys:

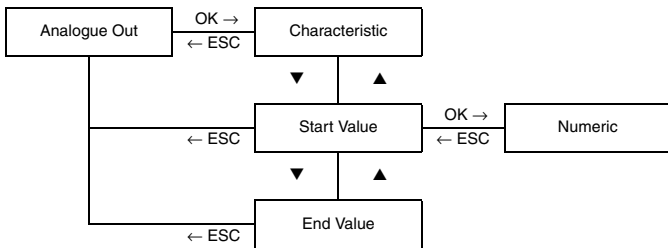

#### 6.1.4 Lowest menu level: choose values, enter numbers

On the lowest level of the menu, you can either select one of several possible values, or enter a number.

Proceed as follows:

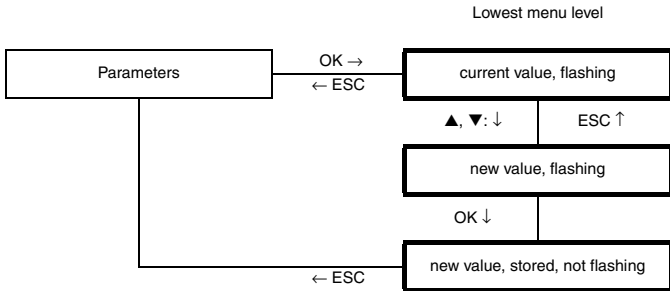

When entering **numeric values**, please note:

- If you press the ▲ or ▼ keys, the value changes step by step.
- If you hold the ▲ or ▼ keys, the value "rolls" to higher or lower values.
- The sign switches automatically.
- The decimal point is moved automatically.



### 6.3 Input

The following illustration shows the menus for the input parameters. Menu options on the lowest level are outlined in bold.

The menu items *Zero* and *Factor* do **not** appear when selecting the unit mA/mV/V (see section 6.2), the menu item *Factor* also does **not** appear when selecting the unit %. The menu *Line Monitor* **only** appears when selecting the input type *0 mA ... 20 mA*.

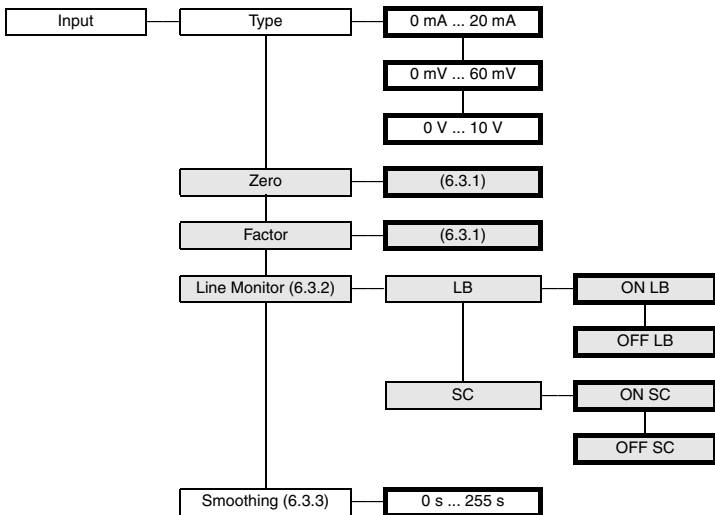

### 6.3.1 Zero and Factor

Dependent on *type* (see section 6.3) the USC measures in mA, mV or V. If you have selected a different *unit* (see section 6.2), the USC calculates the measured value in the selected unit using the parameters *Zero* and *Factor* on the basis of the following formula:

- Measured value in the selected unit = (original measured value - Zero) x Factor

Any values within 0 % ... 90 % of the measuring range of the input type can be set as *Zero* (18 mA, 54 mV or 9 V), values between 0.100 and 4999 as *Factor*.

The unit designation (except %) does not affect the calculation.

For the unit % it is not possible to select a Factor. According to the input type the Factor 100/(max - Zero) will always be used, with max = 20 mA, 60 mV or 10 V.



Note

*An example can be found in the appendix to the manual.*

### 6.3.2 Line Monitor

The menu *Line Monitor* only appears when selecting the input type *0 mA ... 20 mA*.

- If you select **ON LB**, an input current < 0.2 mA will register as a lead breakage (see section 5).
- If you select **ON SC**, an input current > 22 mA will register as a short circuit (see section 5).

If input values ≤ 0.2 mA are to be processed as measuring values, you have to disable the lead breakage monitoring function (OFF LB). Otherwise an error message will be issued within the measuring range.

### 6.3.3 Smoothing

For extremely variable measurement values, you can use **Smoothing** to influence how quickly an output reacts to a change in input value: 0 s = no smoothing, 255 s = maximum smoothing.

## 6.4 Relay

The following figure shows the menus for the relay output. Menu options on the lowest level are outlined in bold. For the analogue output see section 6.5.

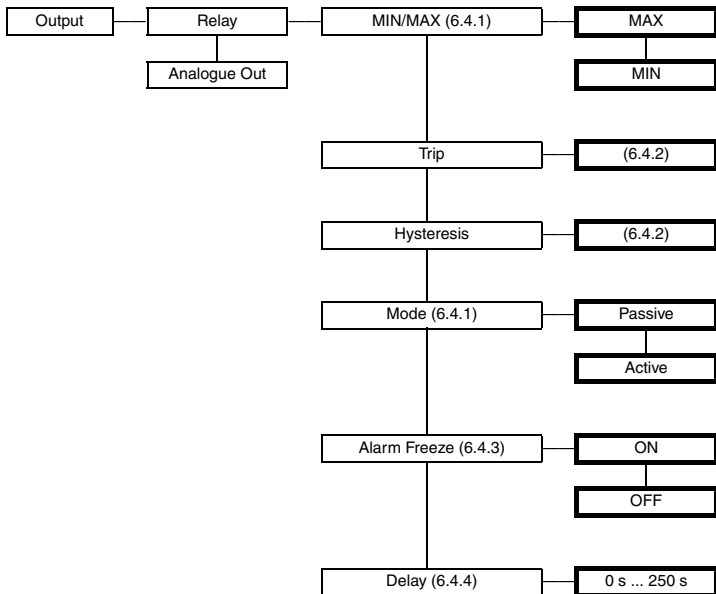

### 6.4.1 Operating behaviour

The switching modes *MAX* or *MIN* are possible, and the Mode *Active* or *Passive* are possible (see section 6.4).

Areas of Application:

- Switching Mode *MAX*, Mode *Active*: Alarm on over range, e. g. audible alarm on
- Switching Mode *MAX*, Mode *Passive*: Switching when above limit value, e. g. pump, heating, ... off; for a large hysteresis MIN-MAX operation
- Switching Mode *MIN*, Mode *Active*: Alarm on under range, e. g. audible alarm on
- Switching Mode *MIN*, Mode *Passive*: Switching when below limit value, e. g. pump, heating, ... off; for a large hysteresis MIN-MAX operation

The exact operating behaviour of the USC can be seen in the following illustration:

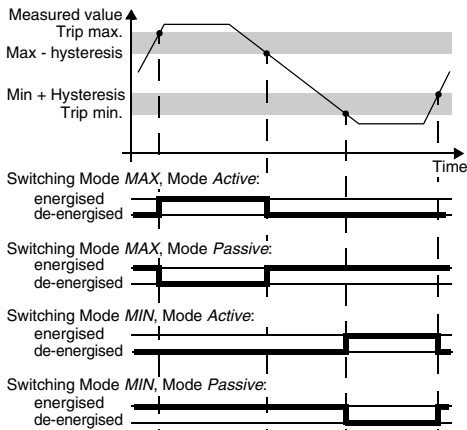

#### 6.4.2 Trip and hysteresis

Please note when entering values for *trip* and *hysteresis*:

- Both values are to be entered in the unit that was selected under *Unit* (see section 6.2).
- Dependent on the selected *type* (see section 6.3) it is possible to enter values
  - between 0 mA and 24 mA
  - between 0 mV and 72 mV
  - between 0 V and 12 V
  - between the conversions of the limits of the input type into the selected unit; for conversion using the parameters *Zero* and *Factor* see section 6.3.1
- The hysteresis must be > 1% of the trip in order to prevent rapid switching of the relay.
- As the representation of the operating behaviour in Section 6.4.1 shows, the following must apply:
  - for the switching Mode *MAX*:  $\text{trip} - \text{hysteresis} \geq 0$
  - for the switching Mode *MIN*:  $\text{trip} + \text{hysteresis} \leq \text{upper limit of the trip}$

The input limits are automatically preset by the USC.

#### 6.4.3 Alarm Freeze

By means of the **Alarm Freeze** you ensure that the operating personnel notices if the trip value is temporarily violated.

If **Alarm Freeze ON** has been selected, the new condition is maintained after switching the relay, until the **ESC** key is pressed or the device is restarted. These actions reset the relay, unless the trip value is still exceeded.

#### 6.4.4 Delay

If you set a time delay  $> 0$  s, you prevent short-time violations of the trip value from triggering an alarm.

- The relay only switches if the trip is exceeded/fallen short of for a period that is longer than the delay time.
- The relay only switches back if the trip  $-/+$  hysteresis is fallen short of/exceeded for a period that is longer than the delay time.
- If the trip is exceeded/fallen short of for a short time, this does not have any effects.

The following figure shows the operating behaviour for the switching Mode *MAX*, Mode *Active*.

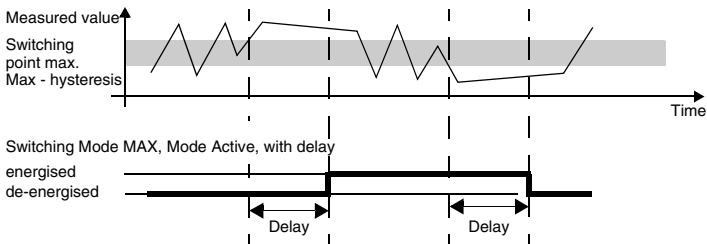

The time delay can be set between 0 s and 250 s.

## 6.5 Analogue Out

The following figures show the menus for the analogue output. Menu options on the lowest level are outlined in bold. For the relay output see section 6.4.

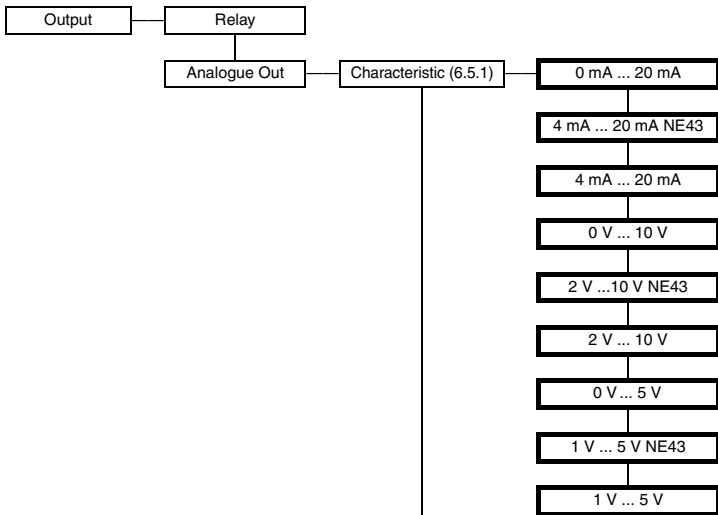

Continued on next page (offset)

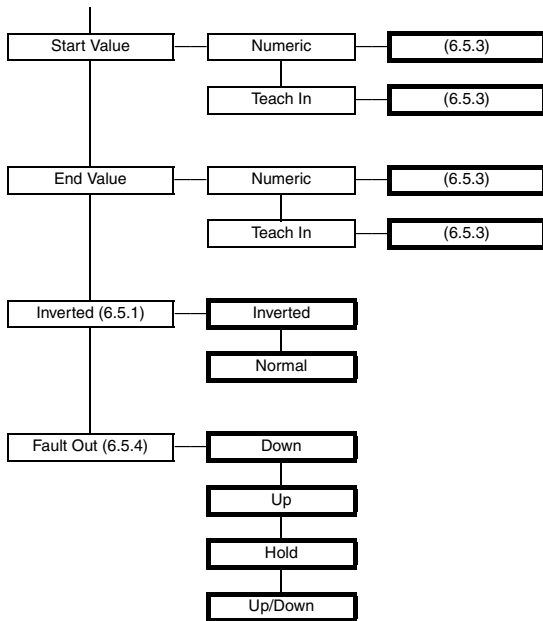

### 6.5.1 Characteristic

Using the parameters *Start Value* and *End Value* you can define a partial range of the input signal as measuring range of the application (see section 6.5.3). This measuring range is represented linear in the output signal.

The following table shows for the various characteristics (see section 6.3) the implementation of *Start Value* and *End Value* and the behavior of measuring range overruns.

- The details apply for the setting *Inverted* → *Normal*.
- If you select *Inverted* → *Inverted*, the conversion of start value and end value will be inverted. The start value will therefore be implemented in 5 V, 10 V or 20 mA, the end value in 0 V, 1 V, 2 V, 0 mA or 4 mA.
- Measuring range overruns exceeding the linear range described cannot be evaluated. For such overruns the stated value is constantly output. The linear range can be limited when the measuring range overrun reaches the limits of the input type.

Characteristic	Start Value implemented in	End Value implemented in	Underrun linear up to	Overrun linear up to
1 V ... 5 V	1 V	5 V	0 V	approx. 5.5 V
1 V ... 5 V NE43	1 V	5 V	0.95 V	5.125 V
0 V ... 5 V	0 V	5 V	0 V	5.125 V
2 V ... 10 V	2 V	10 V	0 V	approx. 11 V
2 V ... 10 V NE43	2 V	10 V	1.9 V	10.25 V
0 V ... 10 V	0 V	10 V	0 V	10.25 V
4 mA - 20 mA	4 mA	20 mA	0 mA	approx. 22 mA
4 mA ... 20 mA NE43	4 mA	20 mA	3.8 mA	20.5 mA
0 mA ... 20 mA	0 mA	20 mA	0 mA	20.5 mA

### 6.5.2 Examples for representations of the input signal in the output signal

Input type 0 V ... 10 V, characteristic 4 mA ... 20 mA NE43, start value 2 V, end value 6 V

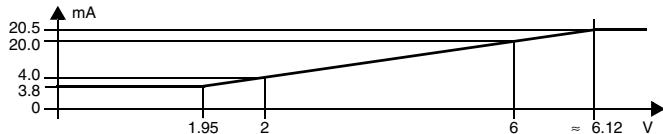

Input type 0 mV ... 60 mV, characteristic 2 V ... 10 V, start value 5 mV, end value 45 mV

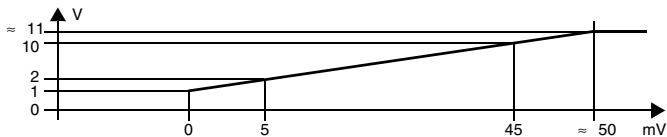

Input type 0 mA ... 20 mA, characteristic 0 mA ... 20 mA, start value 4 mA, end value 20 mA

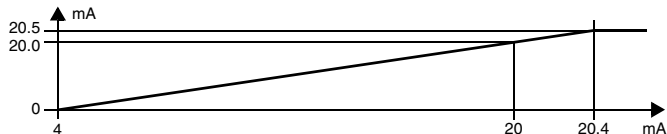

### 6.5.3 Start and end values

In the menu items *Numeric* you can enter the start and end values of the measuring range in figures. When doing so please note:

- Both values are to be entered in the unit that was selected under *Unit* (see section 6.2).
- Dependent on the selected *type* (see section 6.3) it is possible to enter values
  - between 0 mA and 20 mA
  - between 0 mV and 60 mV
  - between 0 V and 10 V
  - between the conversions of the limits of the input type into the selected unit; for conversion using the parameters *Zero* and *Factor* see section 6.3.1
- The difference between end value and start value must be at least 1 % of the end value (automatic preset by the USC).

If you press the OK key in the menu items *Calibration*, the current measured value will be displayed. When pressing the OK key again the measured value will be accepted as start value or end value of the measuring range (only if the start value is at least 1 % smaller than the end value).



Note

*An example can be found in the appendix to the manual.*

#### 6.5.4 Fault Out

The following table shows the values of the analogue output during a fault, depending on the characteristic.

Setting	1 V ... 5 V/2 V ... 10 V/ 4 mA ... 20 mA	1 V ... 5 V/2 V ... 10 V/ 4 mA ... 20 mA NE43	0 V ... 5 V/0 V ... 10 V/ 0 mA ... 20 mA
Up/Down	5.375 V/10.75 V/21.5 mA	5.375 V/10.75 V/21.5 mA	5.375 V/10.75 V/21.5 mA
	in the case of short circuit	in the case of short circuit	in the case of short circuit
	(cannot be distinguished from value exceeding end value)		
	0 V/0 V/0 mA	0.5 V/1 V/2.0 mA	0 V/0 V/0 mA
	in the case of lead breakage	in the case of lead breakage	in the case of lead breakage
	(cannot be distinguished from value below start value)		(cannot be distinguished from measurement below start value)
Hold	last measured value before the fault		
Up	5.375 V/10,75 V/21.5 mA	5.375 V/10,75 V/21.5 mA	5.375 V/10,75 V/21.5 mA
	(cannot be distinguished from value exceeding end value)		
Down	0 V/0 V/0 mA	0.5 V/1 V/2.0 mA	0 V/0 V/0 mA
	(cannot be distinguished from value below start value)		(cannot be distinguished from measurement below start value)

## 6.6 Service

The following illustration shows the menus for the service parameters. The menu options of the lowest menu level are surrounded by a bold box.

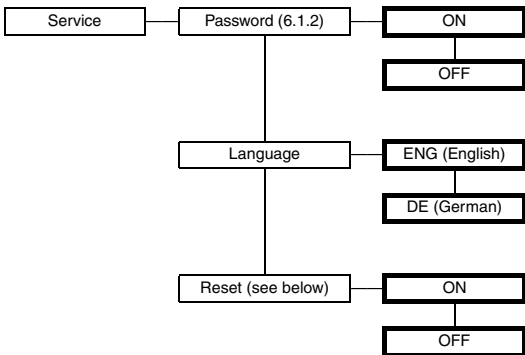

**Reset:** If *ON* is flashing and you press the *OK* key, all settings of the USC will be reset to the factory settings (see section 6.7). All entries which you have ever made in parameterisation mode will be lost.

## 6.7 Factory settings

Menu	Parameters	Factory setting	Own value
Main menu	Unit	mA	
Input	Type	0 mA ... 20 mA	
	Zero	4.000 mA/2.00 V/12.00 mV	
	Factor	1.000	
	Line monitor	ON LB/ON SC	
	Smoothing	3 s	
Relay output	MIN/MAX (= switching Mode)	MIN	
	Trip	16.000 mA	
	Hysteresis	2.000 mA	
	Mode	Passive	
	Alarm Freeze	OFF	
	Delay	0 s	
Analogue Out	Characteristic	0 mA ... 20 mA	
	Start Value	0.000 mA	
	End Value	20.000 mA	
	Inverted	Normal	
	Fault Out	Down	
Service	Password	OFF	
	Language	ENG	

## 7 Example level measurement

The level in a water tank with a max. volume of 3000 liter is to be measured using a pressure sensor. By fitting a sensor a signal is already measured in the empty container due to the liquid column in the assembly connection (figure 1).

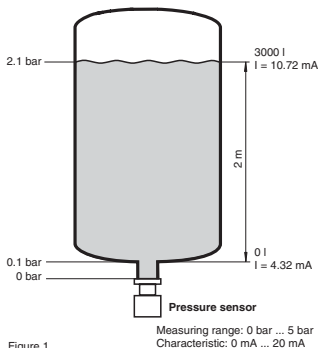

A pressure sensor with a measuring range of 5 bar and an output signal of 4 mA ... 20 mA is being used. With the full container the pressure sensor measures a pressure of 2.1 bar and outputs a current of 10.72 mA (figure 2).

The level is to be measured and displayed using the universal signal conditioner KF8-USC-1.D.

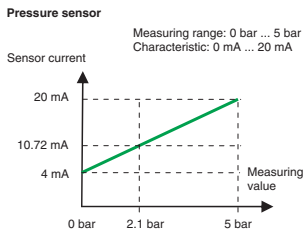

## 7.1 Input parameters and unit

- The USC is to indicate the pressure at the pressure sensor in bar. This also takes account of the liquid column in the connection piece.
  - Zero: 4 mA
  - Factor:  $2.1 \text{ bar}/(10.72 - 4) \text{ mA}$   
= 0.313 bar/mA
  - Input: 0.313

These settings result in indicating the measured pressure (figure 3).

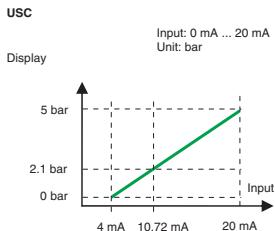

Figure 3

- The USC is to indicate the useable level in the container in liters. At 0 liter the sensor already measures a pressure due to its assembly in the connection piece. The result is the characteristic in figure 4.
  - Zero: 4.32 mA
  - Factor:  $3000 \text{ l}/(10.72 \text{ mA} - 4.32 \text{ mA})$   
= 468.8 l/mA
  - Input: 468.8

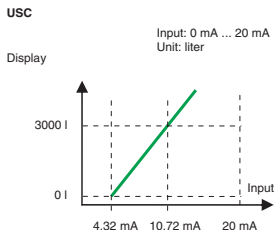

Figure 4

## 7.2 Output parameters

The analogue output will be set to 0 V ... 10 V. At 0 liter 0 V, at 3000 liter 10 V are to be output. The result is the characteristic in figure 5. The following parameters have to be entered in the USC:

- Start Value: 0 l
- End Value: 3000 l

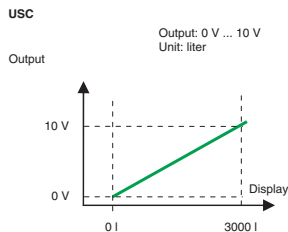

Figure 5



With regard to the supply of products, the current issue of the following document is applicable:  
The general terms of delivery for products and services of the electrical industry, as published  
by the central association of the "Elektrotechnik und Elektroindustrie (ZVEI) e.V.",  
including the supplementary clause "Extended reservation of title".

## PROCESS AUTOMATION – PROTECTING YOUR PROCESS



### Worldwide Headquarters

Pepperl+Fuchs GmbH  
68307 Mannheim - Germany  
Tel. +49 621 776-0  
E-mail: [info@de.pepperl-fuchs.com](mailto:info@de.pepperl-fuchs.com)

### USA Headquarters

Pepperl+Fuchs Inc.  
Twinsburg, Ohio 44087 - USA  
Tel. +1 330 4253555  
E-mail: [sales@us.pepperl-fuchs.com](mailto:sales@us.pepperl-fuchs.com)

### Asia Pacific Headquarters

Pepperl+Fuchs Pte Ltd.  
Company Registration No. 199003130E  
Singapore 139942  
Tel. +65 67799091  
E-mail: [sales@sg.pepperl-fuchs.com](mailto:sales@sg.pepperl-fuchs.com)

[www.pepperl-fuchs.com](http://www.pepperl-fuchs.com)

 **PEPPERL+FUCHS**  
PROTECTING YOUR PROCESS

Subject to modifications  
Copyright PEPPERL+FUCHS • Printed in Germany

DOCT-0969C 193758  
08/2007



# SCATTERGOOD & JOHNSON LTD

ELECTRICAL ENGINEERING & FLUID CONTROL DISTRIBUTORS

Est.1899

At Scattergood & Johnson Ltd, we pride ourselves on being a technical distributor to specialist industries.

Working with a range of quality product suppliers across a number of specialist markets, we are not your average 'box shifter' - we are your technical and supply chain partner.

We fully support every product we sell - for free! Our internal team and external sales engineers can answer any product or application question, no matter the complexity.

Backing up this technical ability is a range of 50,000+ products available from stock for nationwide next day delivery (same day if required!), or you can collect what you need from any of our trade counters around the UK.

Select your specialist interest below to learn more about how we can help.

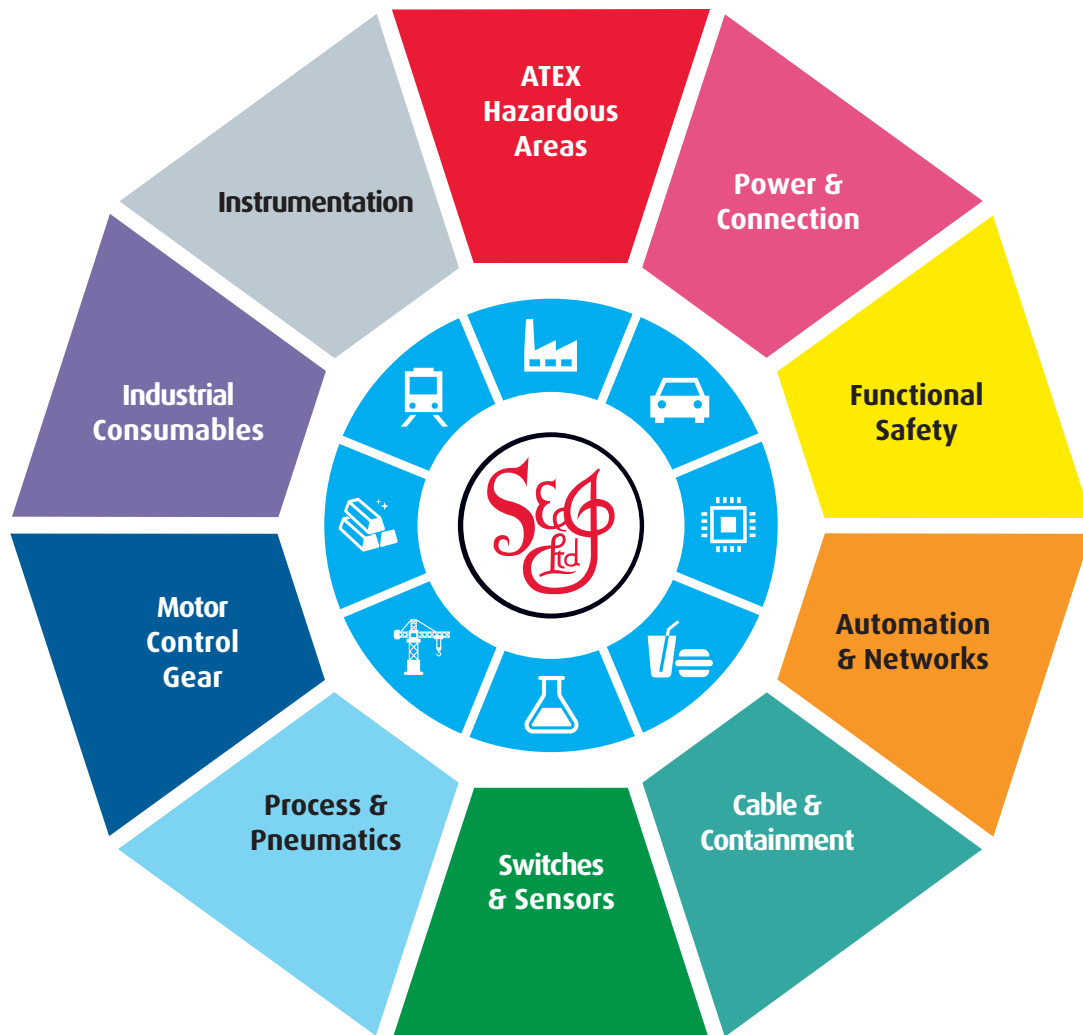

Online, In Branch and On the Road - Scattergood & Johnson Ltd, there when you need us.

# [www.scatts.co.uk](http://www.scatts.co.uk)