



Model Number

UB800-F12-U-V15

Single head system

Features

- Evaluation limits can be taught-in
- Selectable sound lobe width
- Synchronization options
- Very small unusable area
- Temperature compensation

Diagrams

Characteristic response curve

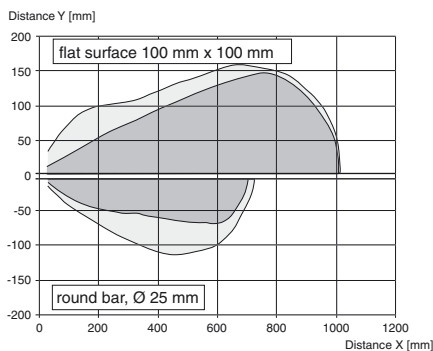

Technical data

General specifications	
Sensing range	30 ... 800 mm
Adjustment range	50 ... 800 mm
Dead band	0 ... 30 mm
Standard target plate	100 mm x 100 mm
Transducer frequency	approx. 310 kHz
Response delay	approx. 100 ms
Indicators/operating means	
LED green	Operating display
LED yellow	Evaluation range indicator, Ready for programming
LED red	Ready for programming, Fault
Electrical specifications	
Operating voltage U_B	12 ... 30 V DC
No-load supply current I_0	≤ 30 mA
Input/Output	
Synchronization	1 synchronous connection, bi-directional 0-level: $-U_B \dots +1$ V 1-level: $+4$ V $\dots +U_B$ input impedance: > 12 k Ω synchronization pulse: ≥ 100 μ s, synchronization interpulse period: ≥ 2 ms
Synchronization frequency	
Common mode operation	≤ 45 Hz
Multiplex operation	≤ 45/n Hz, n = number of sensors
Input	
Input type	1 program input Switching distance 1: $-U_B \dots +1$ V, Switching distance 2: $+3$ V $\dots +U_B$ Input impedance: > 10 k Ω
Pulse length	≥ 1 s
Output	
Output type	1 analog output 0 ... 10 V
Default setting	evaluation limit A1: 50 mm, evaluation limit A2: 800 mm, wide sound lobe, rising ramp
Repeat accuracy	≤ 1 %
Load impedance	≥ 500 Ohm
Temperature influence	± 1.5 % of full-scale value
Ambient conditions	
Ambient temperature	-15 ... 70 °C (5 ... 158 °F)
Storage temperature	-40 ... 85 °C (-40 ... 185 °F)
Mechanical specifications	
Connection type	Connector plug M12 x 1, 5-pin
Degree of protection	IP54
Material	
Housing	Frame: nickel plated, die cast zinc, Laterals: glass-fiber reinforced plastic PC
Transducer	epoxy resin/hollow glass sphere mixture; foam polyurethane, cover PBT
Mass	60 g
Compliance with standards and directives	
Standard conformity	
Standards	EN 60947-5-2:2007+A1:2012 IEC 60947-5-2:2007 + A1:2012 EN 60947-5-7:2003 IEC 60947-5-7:2003
Approvals and certificates	
UL approval	cULus Listed, General Purpose
CSA approval	cCSAus Listed, General Purpose
CCC approval	CCC approval / marking not required for products rated ≤36 V

Release date: 2016-04-25 09:25 Date of issue: 2019-01-25 202068_eng.xml

Dimensions

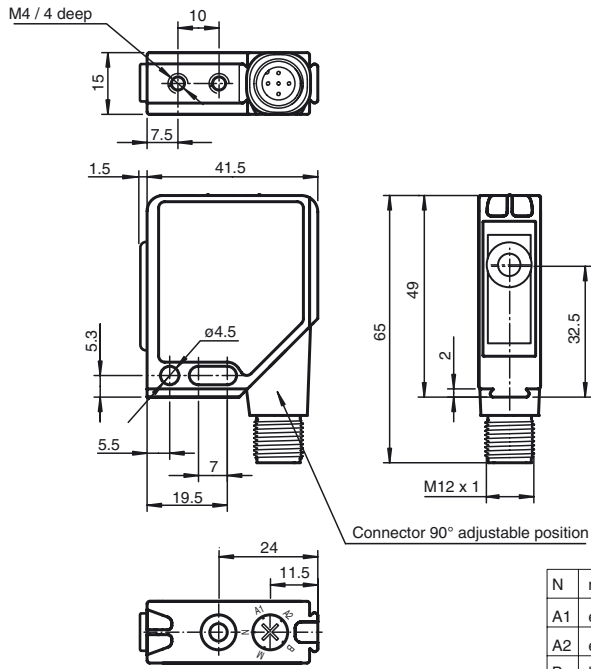

N	normal operation	Teach-IN
A1	evaluation limit 1	
A2	evaluation limit 2	
B	light beam characteristics	
M	operating mode	

Electrical Connection

Standard symbol/Connections:
(version U)

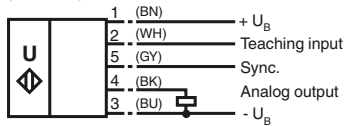

Core colours in accordance with EN 60947-5-2.

Pinout

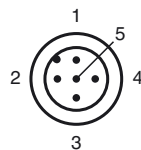

Wire colors in accordance with EN 60947-5-2

1	BN	(brown)
2	WH	(white)
3	BU	(blue)
4	BK	(black)
5	GY	(gray)

Additional Information

Analogue output programming

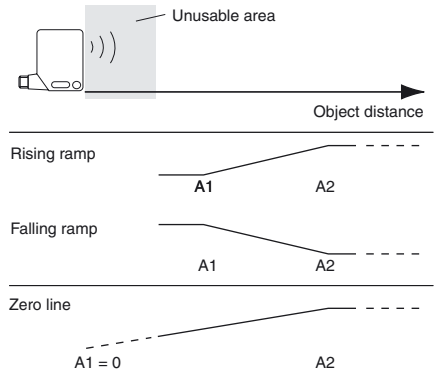





- Return the selector switch to position N when the desired operating mode is displayed.
Note: Acceptance of the operating mode into the permanent memory of the sensor does not take place until the selector switch is set to N. If this acceptance does not take place within a time window of 5 minutes, the sensor continues to operate with unchanged operating mode and the red and yellow LEDs flash.

Parameter assignment of the ultrasonic beam breadth

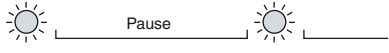
Within a time window of 5 minutes from switching on the power supply the sensor is ready for adaptation of the ultrasonic beam breadth.

- Set the selector switch to position B (Beam). The flashing sequence of the green LED indicates the currently set ultrasonic beam breadth.
- The optional beam breadths are selected by brief actuation of the TEACH-IN button (See flashing sequence of the green LED).

Characteristic	Flashing sequence of the green LED	T-Button
Narrow beam		
Medium beam		
Broad beam		

- Return the selector switch to position N when the desired beam breadth is indicated.
Note: Acceptance of the ultrasonic beam breadth into the permanent memory of the sensor does not take place until the selector switch is set to N. If this acceptance does not take place within the 5 minute time window, the sensor continues its operation with an unchanged ultrasonic beam breadth and the red and yellow LEDs flash.

Synchronisation

A synchronisation connection is provided for the suppression of mutual interference. If this is unused, or connected to 0V, then the sensor operates with an internally generated clock-pulse rate. The synchronisation of a number of sensors can be achieved by the following means.

External synchronisation:

The sensor can be synchronised by the external application of a square-wave voltage. A synchronisation pulse at the synchronisation input leads to the execution of a measuring cycle. The pulse width must be greater than 1.2 ms. The measuring cycle starts with the falling ramp. A low level > 1 s or an open synchronisation input leads to the normal operation of the sensor. A high level at the synchronisation input deactivates the sensor.

Two operating modes are possible.

- A number of sensors are triggered by the same synchronisation signal. The sensors operate in common mode.
- The synchronisation pulses are fed cyclically to one sensor at a time. The sensors operate in multiplex mode.

Self-synchronisation:

The synchronisation connections of up to 5 sensors are connected together to provide the option of self-synchronisation. When the operating voltage is switched on these sensors operate in multiplex mode. The switch-in delay increases depending on the number of sensors to be synchronised. Synchronisation cannot take place during teach-in and vice-versa. The sensors must be operated unsynchronised for the teaching-in of the switch points.

Note:

If the synchronisation option is not used, then the synchronisation input is connected to earth (0V) or the sensor is operated with a V1 connection cable (4-pole).

Release date: 2016-04-25 09:25 Date of issue: 2019-01-25 202088_eng.xml



SCATTERGOOD & JOHNSON LTD

ELECTRICAL ENGINEERING & FLUID CONTROL DISTRIBUTORS

Est.1899

At Scattergood & Johnson Ltd, we pride ourselves on being a technical distributor to specialist industries.

Working with a range of quality product suppliers across a number of specialist markets, we are not your average 'box shifter' - we are your technical and supply chain partner.

We fully support every product we sell - for free! Our internal team and external sales engineers can answer any product or application question, no matter the complexity.

Backing up this technical ability is a range of 50,000+ products available from stock for nationwide next day delivery (same day if required!), or you can collect what you need from any of our trade counters around the UK.

Select your specialist interest below to learn more about how we can help.



Online, In Branch and On the Road - Scattergood & Johnson Ltd, there when you need us.

www.scatts.co.uk