



Model Number

UC500-30GM-E6R2-V15

Single head system

Features

- **Parameterization interface for the application-specific adjustment of the sensor setting via the service program ULTRA 3000**
- **2 programmable switch outputs**
- **Hysteresis mode selectable**
- **Window mode selectable**
- **Synchronization options**
- **Adjustable acoustic power and sensitivity**
- **Temperature compensation**

Diagrams

Characteristic response curve

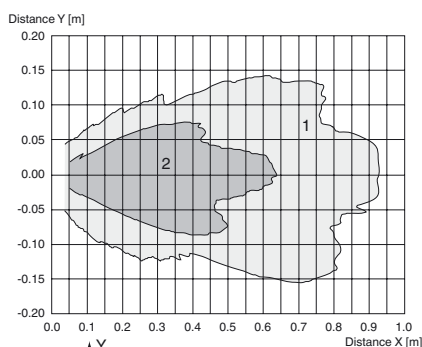

Curve 1: flat surface 100 mm x 100 mm
Curve 2: round bar, Ø 25 mm

Technical data

General specifications

| | |
|-----------------------|--|
| Sensing range | 30 ... 500 mm |
| Adjustment range | 50 ... 500 mm |
| Dead band | 0 ... 30 mm |
| Standard target plate | 100 mm x 100 mm |
| Transducer frequency | approx. 380 kHz |
| Response delay | 21 ms minimum 63 ms factory setting |

Indicators/operating means

| | |
|--------------------------------|--|
| LED green | solid: Power-on flashing: Standby mode or program function object detected |
| LED yellow 1 | solid: switching state switch output 1 flashing: program function |
| LED yellow 2 | solid: switching state switch output 2 flashing: program function |
| LED red | solid: temperature/program plug not connected flashing: fault or program function object not detected |
| Temperature/TEACH-IN connector | Temperature compensation , Switch points programming , output function setting |

Electrical specifications

| | |
|------------------------------|--|
| Operating voltage U_B | 10 ... 30 V DC , ripple 10 % _{SS} |
| No-load supply current I_0 | ≤ 50 mA |

Interface

| | |
|----------------|---|
| Interface type | RS 232, 9600 Bit/s , no parity, 8 data bits, 1 stop bit |
|----------------|---|

Input/Output

| | |
|---------------------------|--|
| Synchronization | bi-directional 0 level: $-U_B \dots +1 V$ 1 level: $+4 V \dots +U_B$ input impedance: > 12 KOhm synchronization pulse: ≥ 100 μs, synchronization interpulse period: ≥ 2 ms |
| Synchronization frequency | |
| Common mode operation | ≤ 95 Hz |
| Multiplex operation | ≤ 95 Hz / n , n = number of sensors , n ≤ 5 |

Output

| | |
|-------------------------------|---|
| Output type | 2 switch outputs PNP, NO/NC, programmable |
| Rated operating current I_e | 200 mA , short-circuit/overload protected |
| Voltage drop U_d | ≤ 2.5 V |
| Repeat accuracy | ≤ 0.1 % of full-scale value |
| Switching frequency f | ≤ 7 Hz |
| Range hysteresis H | 1 % of the adjusted operating range (default settings), programmable |
| Temperature influence | ≤ 2 % from full-scale value (with temperature compensation) ≤ 0.2 %/K (without temperature compensation) |

Ambient conditions

| | |
|---------------------|--------------------------------|
| Ambient temperature | -25 ... 70 °C (-13 ... 158 °F) |
| Storage temperature | -40 ... 85 °C (-40 ... 185 °F) |

Mechanical specifications

| | |
|----------------------|--|
| Connection type | Connector M12 x 1 , 5-pin |
| Degree of protection | IP65 |
| Material | |
| Housing | stainless steel (1.4305 / AISI 303) PBT plastic parts |
| Transducer | epoxy resin/hollow glass sphere mixture; polyurethane foam |
| Mass | 140 g |

Factory settings

| | |
|----------|--|
| Output 1 | Switching point: 60 mm output function: Switch point operation mode output behavior: NO contact |
| Output 2 | Switching point: 500 mm output function: Switch point operation mode output behavior: NO contact |

Compliance with standards and directives

| | |
|---------------------|---|
| Standard conformity | |
| Standards | EN 60947-5-2:2007 + A1:2012 IEC 60947-5-2:2007 + A1:2012 |

Approvals and certificates

| | |
|--------------|--|
| UL approval | cULus Listed, General Purpose |
| CSA approval | cCSAus Listed, General Purpose |
| CCC approval | CCC approval / marking not required for products rated ≤36 V |

Release date: 2016-04-25 09:35 Date of issue: 2016-04-25 10:21:57_eng.xml

Dimensions

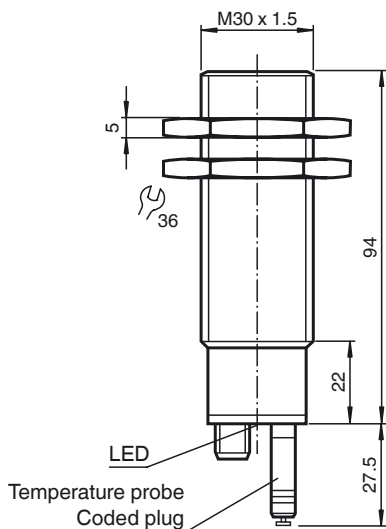

Electrical Connection

Standard symbol/Connection:
(version E6, pnp)

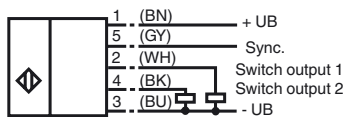

Core colors in accordance with EN 60947-5-2.

Pinout

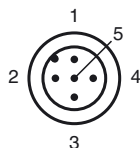

Wire colors in accordance with EN 60947-5-2

| | | |
|---|----|---------|
| 1 | BN | (brown) |
| 2 | WH | (white) |
| 3 | BU | (blue) |
| 4 | BK | (black) |
| 5 | GY | (gray) |

Additional Information

Possible operating modes

1. Switch point mode

When $A1 < A2$, both switch outputs are activated as N.O. contacts.

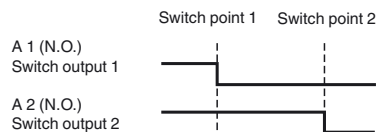

When $A1 > A2$, both switch outputs are activated as N.C. contacts.

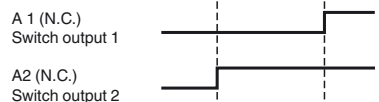

2. Window mode

To exchange the switching distances is of no effect.

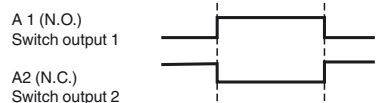

3. Latching mode

To exchange the switching distances is of no effect.

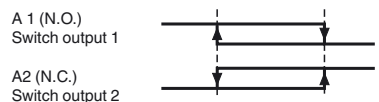

Accessories

BF 30

Mounting flange, 30 mm

BF 30-F

Mounting flange with dead stop, 30 mm

BF 5-30

Universal mounting bracket for cylindrical sensors with a diameter of 5 ... 30 mm

UVW90-M30

Ultrasonic -deflector

UVW90-K30

Ultrasonic -deflector

UC-30GM-PROG

ULTRA3000

Software for ultrasonic sensors, comfort line

UC-30GM-R2

V15-G-2M-PVC

Female cordset, M12, 5-pin, PVC cable

Description of Sensor Functions

Programming procedure

The sensor features 2 programmable switch outputs with programmable switch points. Programming the switch points and the operating mode is done either via the sensors RS232 interface and the ULTRA 3000 software (see the ULTRA 3000 software description) or by means of the programming plug at the sensors rear end which is described here.



Programming switch points 1 and 2

1. Disconnect supply voltage
2. Remove the programming plug to activate program mode.
3. Reconnect supply voltage (Reset)
4. Place the target at the desired switch point position for A1
5. Momentarily insert the programming plug in position A1 and then remove. This will program the switch point A1.
6. Place the target at the desired switch point position for A2
7. Momentarily insert the programming plug in position A2 and then remove. This will program the switch point A2.

Notes:

- Removing the programming plug saves the new switch point position into the device memory.
- The programming status is indicated by the LED. A flashing green LED indicates that the target is detected; a flashing red LED indicates that no target is detected.

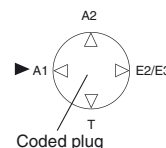

Programming the operation mode

If the program mode is still activated, continue at number 4. If not, activate program mode by performing the sequence numbers 1 to 3.

1. Disconnect supply voltage
2. Remove the programming plug to activate program mode.
3. Reconnect supply voltage (Reset)
4. Insert the programming plug in position E2/E3. By removing and reinserting the plug, the user can toggle through the three different modes of operation. The selected mode is indicated by the LEDs as shown below:
 - Switch point mode, LED A1 flashes
 - Window mode, LED A2 flashes
 - Latching mode, LEDs A1 and A2 flash
5. Once the desired mode is selected, insert the programming plug in position T. This completes the programming procedure and saves the switch points and mode of operation.
6. The sensor now operates in normal mode.

Note:

The programming plug also functions as the temperature compensation. If the programming plug has not been inserted in the T position within 5 minutes, the sensor will return to normal operating mode with the latest saved values, without temperature compensation.

Factory settings

See technical data.

Display

The sensor provides LEDs to indicate various conditions.

| | Green LED | Red LED | Yellow LED A1 | Yellow LED A2 |
|------------------------------------|-----------|----------|---------------------------|---------------------------|
| During Normal Operation | | | | |
| - Temperature compensated | On | Off | Switching state A1 | Switching state A2 |
| - with removed programming plug | Off | On | Switching state A1 | Switching state A2 |
| Interference (e.g. compressed air) | Off | Flashing | remains in previous state | remains in previous state |
| During Sensor Programming | | | | |
| Switch point A1: | | | | |
| Object detected | Flashing | Off | Flashing | Off |
| No object detected | Off | Flashing | Flashing | Off |
| Switch Point A2: | | | | |
| Object detected | Flashing | Off | Off | Flashing |
| No object detected | Off | Flashing | Off | Flashing |
| Operation mode: | | | | |
| Switch point mode | On | Off | Flashing | Off |
| Window mode | On | Off | Off | Flashing |
| Latching mode | On | Off | Flashing | Flashing |
| Standby | Flashing | Off | previous state | previous state |

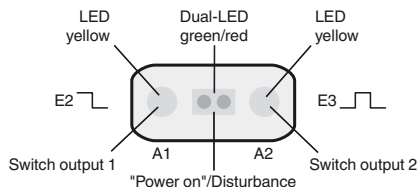

Synchronization

This sensor features a synchronization input for suppressing ultrasonic mutual interference ("cross talk"). If this input is not connected, the sensor will operate using internally generated clock pulses. It can be synchronized by applying an external square wave. The pulse duration must be ≥ 100 μs. Each falling edge of the synchronization pulse triggers transmission of a single ultrasonic pulse. If the synchronization signal remains low for ≥ 1 second, the sensor will revert to normal operating mode. Normal operating mode can also be activated by opening the signal connection to the synchronization input (see note below).

If the synchronization input goes to a high level for > 1 second, the sensor will switch to standby mode, indicated by the green LED. In this mode, the outputs will remain in the last valid output state.

Note:

If the option for synchronization is not used, the synchronization input has to be connected to ground (0 V) or the sensor must be operated via a V1 cordset (4-pin).

The synchronization function cannot be activated during programming mode and vice versa.

The following synchronization modes are possible:

- Several sensors (max. number see technical data) can be synchronized together by interconnecting their respective synchronization inputs. In this case, each sensor alternately transmits ultrasonic pulses in a self multiplexing mode. No two sensors will transmit pulses at the same time (see note below).
- Multiple sensors can be controlled by the same external synchronization signal. In this mode the sensors are triggered in parallel and are synchronized by a common external synchronization pulse.
- A separate synchronization pulse can be sent to each individual sensor. In this mode the sensors operate in external multiplex mode (see note below).
- A high level (+U_B) on the synchronization input switches the sensor to standby mode.

Note:

Sensor response times will increase proportionally to the number of sensors that are in the synchronization string. This is a result of the multiplexing of the ultrasonic transmit and receive signal and the resulting increase in the measurement cycle time.

Note on communication with the UC-30GM-R2 interface cable

The UC-30GM-R2 interface cable allows for communication with the ultrasonic sensor using ULTRA3000 software. The cable creates a connection between a PC RS-232 interface and the programming plug socket on the sensor. When connecting to the sensor, make certain the plug is lined up correctly; otherwise no communication will be possible. The key of the cable's plug must be aligned to the groove of the socket on the sensor (not with the arrow symbol on the sensor).

RS 232-connection

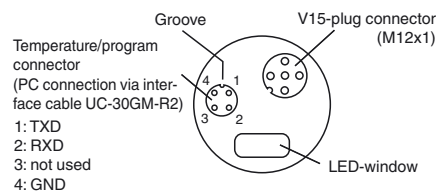

Programmable parameters with the ULTRA3000 software

- Switch point 1 and 2
- NO/NC function
- Operation mode
- Sonic speed
- Temperature offset (The inherent temperature-rise of the sensor can be considered in the temperature compensation)
- Expansion of the unusable area (for suppression of unusable area echoes)
- Reduction of the detection range (for suppression of remote range echoes)
- Time of measuring cycle
- Acoustic power (interference of the burst duration)
- Sensitivity
- Behaviour of the sensor in case of echo loss
- Behaviour of the sensor in case of a fault
- Average formation via an allowed number of measuring cycles
- On/off-delay
- Switching hysteresis
- Selection of the parameter set, RS 232 or manually

Release date: 2016-04-25 09:35 Date of issue: 2016-04-25 102157_eng.xml



Note:

When connected to a PC and running the ULTRA3000 software, the sensor can act as a long term data logger as well.

Release date: 2016-04-25 09:35 Date of issue: 2016-04-25 102157_eng.xml

Refer to "General Notes Relating to Pepperl+Fuchs Product Information".

Pepperl+Fuchs Group
www.pepperl-fuchs.com

USA: +1 330 486 0001
fa-info@us.pepperl-fuchs.com

Germany: +49 621 776 4411
fa-info@pepperl-fuchs.com

Singapore: +65 6779 9091
fa-info@sg.pepperl-fuchs.com



SCATTERGOOD & JOHNSON LTD

ELECTRICAL ENGINEERING & FLUID CONTROL DISTRIBUTORS

Est.1899

At Scattergood & Johnson Ltd, we pride ourselves on being a technical distributor to specialist industries.

Working with a range of quality product suppliers across a number of specialist markets, we are not your average 'box shifter' - we are your technical and supply chain partner.

We fully support every product we sell - for free! Our internal team and external sales engineers can answer any product or application question, no matter the complexity.

Backing up this technical ability is a range of 50,000+ products available from stock for nationwide next day delivery (same day if required!), or you can collect what you need from any of our trade counters around the UK.

Select your specialist interest below to learn more about how we can help.



Online, In Branch and On the Road - Scattergood & Johnson Ltd, there when you need us.

www.scatts.co.uk