

ECOLAB

Model number

VAZ-T1-FK-G10-1M-PUR-V1-G

Splitter box G10, AS-Interface to 1x M12 round connector

Features

- One piece housing
- Simple and fast mounting
- Gold-plated and machined contacts
- Oil and abrasion resistant PUR line appropriate for drag chains
- Immunity to vibration
- Degree of protection IP68 / IP69K
- Halogen-free

Dimensions

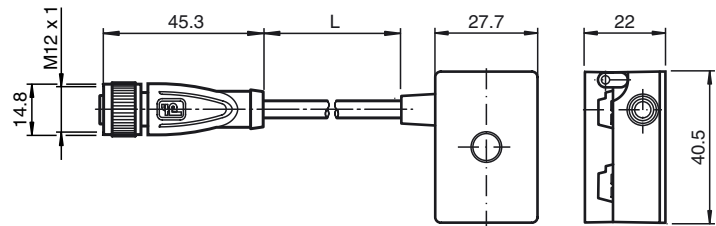

Electrical connection

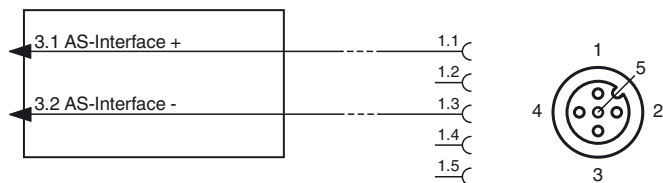

Technical data

General specifications

Construction type	Socket, straight Flat cable terminal AS-Interface
UL File Number	E223772 "For use in NFPA 79 Applications only"

Electrical specifications

Rated operating voltage	U_e	≤ 32 V PELV (AS-Interface)
Rated operating current	I_e	≤ 3 A
Protection class		III
Current loading capacity		max. 4 A
Surge protection		overvoltage category III

Ambient conditions

Ambient temperature	-25 ... 75 °C (-13 ... 167 °F)
Storage temperature	-25 ... 85 °C (-13 ... 185 °F)
Pollution degree	3

Mechanical specifications

Degree of protection	IP67 IP67 / IP68 / IP69K with flat cable VAZ-FK-S-*	
Connection	Flat cable AS-Interface: cable piercing method Plug connection: M12 x 1 socket (V1)	
Material		
Contacts	CuSn / Au	
Housing	PBT PC	
Body	black PUR	
Cable	PUR	
Mounting screw	Stainless steel 1.4305 / AISI 303	
Cable		
Sheath diameter	Ø4,3 mm	
Color	black	
Cores	2 x 0.34 mm ²	
Length	L	1 m
Mass		75 g
Tightening torque, fastening screws		1.65 Nm
Note		The unused flat cable connector is closed with a seal.

Compliance with standards and directives

Standard conformity	
Degree of protection	EN 60529:2000

Approvals and certificates

UL approval	cULus Listed, Type 1 enclosure
-------------	--------------------------------

Maximum permissible ambient temperature $\leq 55\text{ }^{\circ}\text{C}$ ($\leq 131\text{ }^{\circ}\text{F}$)

Notes

Mounting instructions

You may screw the device onto a level mounting surface using two M4 attachment screws. The attachment screws are not included.

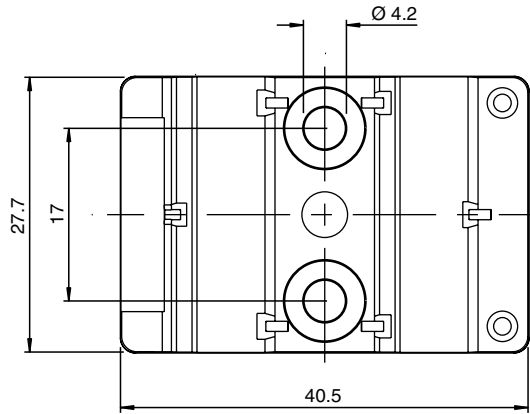

Release date: 2016-11-16 13:22 Date of issue: 2016-11-16 216030_eng.xml



SCATTERGOOD & JOHNSON LTD

ELECTRICAL ENGINEERING & FLUID CONTROL DISTRIBUTORS

Est.1899

At Scattergood & Johnson Ltd, we pride ourselves on being a technical distributor to specialist industries.

Working with a range of quality product suppliers across a number of specialist markets, we are not your average 'box shifter' - we are your technical and supply chain partner.

We fully support every product we sell - for free! Our internal team and external sales engineers can answer any product or application question, no matter the complexity.

Backing up this technical ability is a range of 50,000+ products available from stock for nationwide next day delivery (same day if required!), or you can collect what you need from any of our trade counters around the UK.

Select your specialist interest below to learn more about how we can help.



Online, In Branch and On the Road - Scattergood & Johnson Ltd, there when you need us.

www.scatts.co.uk