



FACTORY AUTOMATION



Instruction Manual

Ultrasonic Double Sheet Monitor UDC-18GM50-400...



fP PEPPERL+FUCHS

With regard to the supply of products, the current issue of the following document is applicable: The General Terms of Delivery for Products and Services of the Electrical Industry, published by the Central Association of the "Elektrotechnik und Elektroindustrie (ZVEI) e.V. including the supplementary clause: „Erweiterter Eigentumsvorbehalt“.

We at Pepper+Fuchs recognise a duty to make a contribution to the future.
For this reason, this printed matter is produced on paper bleached without the use of chlorine.

1	Description of sensor functions	5
2	Working principle.....	5
3	Function input	6
4	Measuring system.....	6
5	Installation and adjustment.....	6
6	Commissioning and parameter assignment.....	8
6.1	Switching on.....	8
6.2	Normal mode	8
6.3	Output pulse extension	9
6.4	Display mode.....	9
6.5	Parameter assignment.....	9
6.6	Modes.....	11
7	Technical data	13
7.1	Electrical connection.....	14
7.2	Dimensions.....	15
8	Accessories	16
9	Notes	17

Hints

These operating instructions provide information on how to use the product properly. They must be read and observed by all persons who use or work with this product. This product is only able to perform the functions for which it was designed if it is used and operated in accordance with information provided by Pepperl+Fuchs.

The warranty assumed by Pepperl+Fuchs for this product is null and void if it is not used and operated in accordance with its proper use as described by Pepperl+Fuchs

Changes to the devices or components and the use of defective or incomplete devices or components are not permitted. Repairs to devices or components may only be performed by Pepperl+Fuchs or authorized work shops. These work shops are responsible for acquiring the latest technical information about

Ultrasonic Double Sheet Monitor UDC-18GM50-400-...**Hints**

Pepperl+Fuchs devices and components. Repair tasks made on the product that are not performed by Pepperl+Fuchs are not subject to influence on the part of Pepperl+Fuchs. Our liability is thus limited to repair tasks that are performed by Pepperl+Fuchs.

The preceding information does not change information regarding warranty and liability in the terms and conditions of sale and delivery of Pepperl+Fuchs.

Subject to technical modifications.

Symbols used

This manual uses symbols to present important information on operating and working safely with the ultrasonic double sheet control UDC-18GM50-400.

The meaning of these symbols is as follows:



Note

Recommendation for the user

Observing this information will make it easier to place the ultrasonic double sheet control UDC-18GM50-400 in operation and work with it.



Attention

This symbol warns the user of possible improper functionality. Failure to heed this warning may result in complete failure of the equipment or other devices that are connected.

1 Description of sensor functions

The ultrasonic double sheet monitor (UDC) is used in all situations in which the automatic distinction between single and double sheets is required in order to protect machines or avoid waste production. The double sheet monitor is based on the ultrasonic through-beam principle. The following can be detected:

- No sheet, i. e. air
- Individual sheet
- Double sheet or multiple sheets (no distinction can be made for the number of sheets)

A microprocessor system evaluates the signals. The appropriate switch outputs are set as a result of the evaluation. Changes in ambient conditions such as temperature and humidity are compensated for automatically.

2 Working principle

The measuring principle of the double sheet control is based on measuring and evaluating the transmitted sound amplitude through a sheet of paper. If there is no paper, no sound is absorbed and the received signal reaches its maximum level. If there are two sheets of paper, one on top of the other, almost all of the signal is absorbed due to multiple reflection between the layers. The amplitude of the signal passing through thus reaches a minimum level. The thicker or denser a given type of paper is, the lower the portion of sound that will pass through it according to the working principle. Because of this, the functionality of the double sheet control is limited to types of paper that fall within a specific range. Paper that is too thin allows too much sound to pass through so that it is not sufficiently different from air. On the other hand, paper that is too thick absorbs so much of the sound that the amplitude for single sheets is already in the range of a double sheet.

Therefore, the double sheet control offers the user 4 different programs for different ranges of material, making it possible to adjust to the ideal setting for different applications. There is no need to perform TEACH-IN for single sheet. This makes the product more user-friendly. Fluttering movements of the paper do not affect reliable operation of the UDC.

Ultrasonic Double Sheet Monitor UDC-18GM50-400-...

Function input

3 Function input

Function input (wire colour pink, PK) is used to adjust the sensor and assign parameters to it. The following functions are available:

- Alignment aid
- Program selection
- Output pulse extension

During normal operation, the function input must always be securely connected with $+U_B$ or $-U_B$, to avoid possible interference or improper functionality.

4 Measuring system

A complete unit consists of an ultrasonic emitter unit and an evaluation and receiver unit. The sensor heads are optimally adjusted to each other when they leave the factory. Therefore, they should not be used separately or exchanged with other devices of the same type. The plug connector on the emitter/receiver connection cable is only intended to be used for easier mounting, not to replace units.

5 Installation and adjustment

Correct functionality of the sensor can only be ensured if the emitter and receiver are adjusted so they are exactly centred on each other. This condition is automatically fulfilled if the MH-UDB01 mounting aid (see chapter 8 "Accessories" on page 16) is used. In addition, the UDC-18GM50 offers an electronic alignment aid (see chapter 6.6.1 "Alignment aid" on page 11).

Recommended spacing between the sensor heads: $d = 40 \text{ mm} \dots 45 \text{ mm}$

Angular misalignment: $\alpha < +/- 1^\circ$

Maximum misalignment: $s < +/- 1 \text{ mm}$

(see Fig. 5.1 and Fig. 5.2 on page 7)

Ultrasonic Double Sheet Monitor UDC-18GM50-400-... Installation and adjustment

Recommended distances

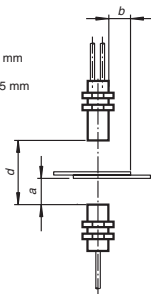
 $a = 5 \dots 15 \text{ mm}$ $d = 40 \dots 45 \text{ mm}$ 

(for very thick papers)

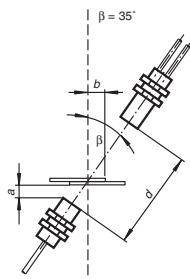

Dimension b: see table in chapter programs

Fig. 5.1: Recommended spacings and angular settings

Thin foil detection $\alpha < +/- 1^\circ$  $s < +/- 1 \text{ mm}$ 

Fig. 5.2: Max. permissible misalignment of the sensor heads

To ensure proper functionality of the double sheet control, the sensor heads must be aligned at an angle of from $\beta = 0^\circ$ to $\pm 45^\circ$ to the perpendicular in reference to the sheet plane; see Fig. 5.1.

Installing the sensor heads vertical to the sheet plane is adequate for most applications.

With very thin sheets, we recommend aligning the sensor heads vertically to the sheet plane ($\beta = 0^\circ$); see Fig. 5.1.

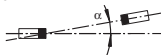
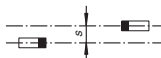
For very thick sheets, we recommend installing the sensor heads at an angle of $\beta = 35^\circ$; see Fig. 5.1.

The sheet is guided at a distance of $a = 10 \text{ mm} \dots 15 \text{ mm}$ above the emitter; see Fig. 5.1.

Ultrasonic Double Sheet Monitor UDC-18GM50-400-... Commissioning and parameter assignment

To prevent accumulations of dust, the emitter should be installed below so that the emitter is always transmitting upward. The ultrasonic signal has a self-cleaning effect. The sensor heads can be fastened in place with the enclosed nuts.

The sound lobe must be completely covered by the paper. That means that the sensor heads must be at least $b = 10$ mm away from the side edge of the paper (see illustration). The direction in which the paper is running makes no difference.

If several UDCs (ultrasonic double sheet monitors) will be operated in the immediate vicinity of each other, acoustic separation should be provided to keep them from interfering with each other. This can be achieved, for example, by positioning metal sheets between them. Installing the units more than 500 mm apart typically results in satisfactory acoustic separation without any additional measures (if the MH-UDB01 mounting aid is used). If one UDC system is emitting signals directly at the receiver of a second system, there may be interference at a distance of up to 1.5 m.

6 Commissioning and parameter assignment

6.1 Switching on

The sensor is equipped with 6 connections. The functionality of the connections is described in the following table. The function input (PK) is used to assign parameters to the sensor. (See Output pulse extension, Alignment aid and Program selection). During normal operation, the function input must always be securely connected with $+U_B$ or $-U_B$, to avoid possible interference or improper functionality.

Colour	Switching on	Comments
BN	$+U_B$	
WH	Switch output for single sheets	Pulse width corresponds to the event
BK	Switch output for double sheets	Pulse width corresponds to the event
GY	Switch output for air	Pulse width corresponds to the event
PK	$-U_B/+U_B$	Function input for parameter assignment/pulse extension
BU	$-U_B$	

6.2 Normal mode

The sensor is working in normal mode if the function input (PK) is applied to $-U_B$ or $+U_B$ when the power source (Power-On) is supplied, as shown in the output pulse extension table (see chapter 6.3 "Output pulse extension" on page 9).

Date of edition: 0.30/3/06

Ultrasonic Double Sheet Monitor UDC-18GM50-400-...

Commissioning and parameter assignment

Displays:

LED yellow: Detection of air

LED green: Detection of single sheets

LED red: Detection of double sheets

Switch outputs:

The switch outputs are only active in normal operation!

White: WH Single sheet output

Black: BK Double sheet output

Gray: GY Air output

6.3 Output pulse extension

Switching the function input (PK) on to $-U_B$ or $+U_B$ makes it possible to select a minimum pulse width of 120 ms for all output pulses of the three switch outputs.

Switching on (PK)	Operating behaviour (after Power-On)
$-U_B$	No output pulse extension for switch outputs
$+U_B$	Output pulse extension of all switch outputs to at least 120 ms

Please note:

This can result in a condition in which more than one switch output is switched through!

6.4 Display mode

The selected parameter assignment of the sensor can be displayed by switching the function input (PK) to voltage-free during normal operation. The green LED displays the program number (the number of flashing pulses (1 ... 4) = the program number).

The outputs are inactive at this time.

If the function input (PK) is unconnected when power is supplied (Power-On), the sensor will also work in display mode (green LED flashes).

If the function input (PK) breaks due to an error while the device is in normal operation mode (broken cable, coming loose because of vibration), display mode acts as a fault display (green LED flashes).

6.5 Parameter assignment

The sensor is equipped with 4 programs for different ranges of application. This makes it possible to work with a wide range of material. The user can select the program best suited for a specific application.

The default setting, Program 1, is designed so that no change in the setting is required for most applications.

Ultrasonic Double Sheet Monitor UDC-18GM50-400-...

Commissioning and parameter assignment

6.5.1 Programs

Program number	Notes*	Range of materials	Dimension b (fig. 5.1)
1	Default setting, standard paper	20 - 1200 g/m ²	> 15 mm
2	Thick paper, cardboard, fine corrugated boards (DIN 55 468-1) and thin sheet metal**	> 100 g/m ²	> 20 mm
3	Thin paper	20 - 250 g/m ²	> 11 mm
4	Extremely fine paper	< 40 g/m ²	> 8 mm

*) The measurements were made under the following conditions: $d = 45 \text{ mm}$, $a = 10 \text{ mm}$, $\beta = 0^\circ$

**) The measurements were made under the following conditions: $d = 45 \text{ mm}$, $a = 10 \text{ mm}$, $\beta = 35^\circ$

6.5.2 Procedure for assigning parameters

It is possible to switch to additional parameter assignment modes from the display mode:

Alignment aid mode -->

Program selection mode -->

Alignment aid mode -->

When the function input (PK) is applied to $-U_B$ (for > 500 ms), the mode changes. When the "Program selection" mode is active, switching on function input (PK) on to $+U_B$ (for > 500 ms) selects the next program level.

Disconnecting the power supply causes the system to exit the current mode with the selected program change.

The switch outputs are not active while parameters are being assigned to the sensor!

Ultrasonic Double Sheet Monitor UDC-18GM50-400-...

Commissioning and parameter assignment

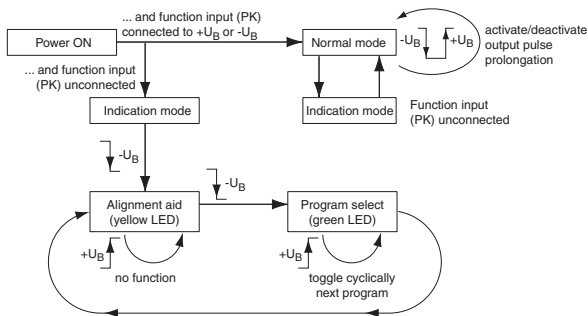

Fig. 6.1: Parameter assignment

6.6 Modes

6.6.1 Alignment aid

During installation, the UDC can provide an adjustment aid for optimal alignment of the emitter to the receiver.

If the sensor detects an area of air (yellow LED is lit) the UDC will begin to display the intensity of the measured amplitude signal after 3 seconds:

If the signal is weak, the yellow LED will flash at a slow rate

As the intensity of the signal increases, the rate at which the LED flashes becomes faster

At optimal alignment (maximum signal intensity), the yellow LED is continuously lit.

The single sheet function (green LED) and double sheet function (red LED) continues to be active. This makes it possible to check for correct functionality of the double sheet control.

6.6.2 Program selection

In the program selection mode, the current program is displayed by the green LED (number of flashing pulses = program number). Applying the adjustment input (PK) to $+U_B$ (for > 500 ms) causes the next program to be selected in cyclic sequence (program 1 follows through to program 4).

Ultrasonic Double Sheet Monitor UDC-18GM50-400-... Commissioning and parameter assignment

Notes:



Note

This sensor is not suitable for detecting contact points or labels. Pepperl+Fuchs does offer equipment developed especially for this purpose.



Note

We recommend using mounting support MH-UDB01 for correct alignment of the sensor heads.



Note

Extremely light papers (for example handkerchiefs) or perforated papers (for example sheets of stamps) are not always suitable for double sheet detection because of their physical characteristics. Material that represent double sheets in and of themselves cannot be used, for example multiply coated material with air cavities in them. These may result from damage (kinking) of paper, for example.



Note

Due to the great variety of types of paper, cards and foils, we strongly recommend trying out the desired range of detection material as part of an approval procedure, for example, before using the sensor. This will ensure optimal reliability in detection.



Attention

The sheets must not touch the sensor heads during operation.

Installation, commissioning and maintenance must only be performed by qualified specialists. The sensor heads must be installed with great care. If the device is not used for a purpose for which it was intended, reliable functionality of the double sheet control cannot be guaranteed. Making changes to or tampering with the device is not permitted.

7 Technical data

General data	
Detection range	20 ... 60 mm, optimal distance: 45 mm
Transducer frequency	395 kHz
Displays/operating elements	
LED green	Display: single sheet detected
LED yellow	LED display: No sheet detected (air)
LED red	LED display: Double sheet detected
Electrical data	
Operating voltage	18 ... 30 V DC, ripple 10 %SS
No-load supply current I_0	< 50 mA
Input	
Input type	Function input 0-level: $-U_B \dots -U_B + 1 \text{ V}$ 1-level: $+U_B - 1 \text{ V} \dots +U_B$
Pulse length	$\geq 100 \text{ ms}$
Impedance	$\geq 4 \text{ k}\Omega$
Output	
Output type	Version -3E0: 3 switch outputs npn, normally open contact Version -3E1: 3 switch outputs npn, normally closed contact Version -3E2: 3 switch outputs prnp, normally open contact Version -3E3: 3 switch outputs prnp, normally closed contact
Rated operating current I_e	3 x 100 mA, short circuit/overload protected
Voltage drop U_d	$\geq 2 \text{ V}$
Switch-on delay t_{on}	Approx. 15 ms
Switch-off delay t_{off}	Approx. 15 ms
Conformity to standards	
Standards	IEC / EN 60947-5-2:2004 C-UL listed: 57M3, IND CONT. EQ., powered by Class II power source
Ambient conditions	
Ambient temperature	0 ... 60 °C (273 ... 333 K)
Storage temperature	-40 ... 85 °C (233 ... 358 K)
Mechanical data	
Protection class	IP67
Connection	2 m, PVC cable 0.14 mm ²
Materials	
Housing	Brass, nickel-plated, PBT plastic components
Transducer	Epoxy resin/hollow glass bead mixture; polyurethane foam
Weight	135 g

Table 7.1: Technical data

7.1 Electrical connection

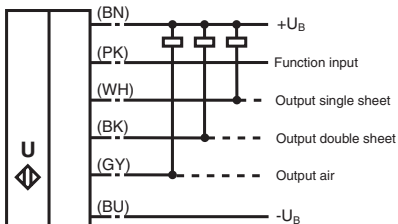

Fig. 7.1: Electrical connection of device versions ...-3E0 and ...-3E1

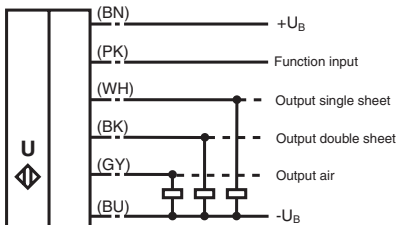

Fig. 7.2: Electrical connection of device versions ...-3E2 and ...-3E3

Ultrasonic Double Sheet Monitor UDC-18GM50-400-... Accessories

8 Accessories

Installation aid: MH-UDB01

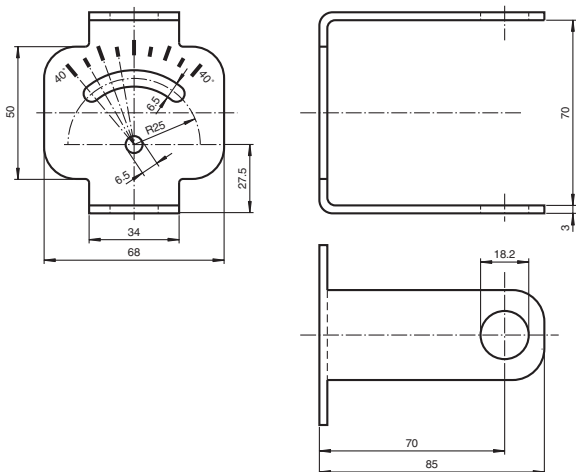

Fig. 8.1: Dimensions of the installation aid MH-UDB01

Extension cord, 1 m: UDC cable, 1 m

Extension cord, 2 m: UDC cable, 2 m

9 Notes

Date of edition: 03/03/06

FACTORY AUTOMATION



PROCESS AUTOMATION



SIGNALS FOR THE WORLD OF AUTOMATION

For half a century Pepperl+Fuchs has been continually providing new impetus to the world of automation. We develop, manufacture and market electronic sensors and interface modules through our worldwide network. Our global presence and highly flexible production and service organisations enable us to offer you complete individual solutions – right where you need us! We know what we are talking about – because today Pepperl+Fuchs is the company with the largest selection of industrial sensor technology in the world – serving an exceptionally broad spectrum of applications.

Our signals move the World.



www.pepperl-fuchs.com

Worldwide Headquarters

Pepperl+Fuchs GmbH · Königsberger Allee 87
68307 Mannheim · Germany
Tel. +49 621 776-0 · Fax +49 621 776-1000
E-mail: info@de.pepperl-fuchs.com

USA Headquarters

Pepperl+Fuchs Inc. · 1600 Enterprise Parkway
Twinsburg, Ohio 44087 · USA
Tel. +1 330 4253555 · Fax +1 330 4254607
E-mail: sales@us.pepperl-fuchs.com

Asia Pacific Headquarters

Pepperl+Fuchs Pte Ltd. · P+F Building
18 Ayer Rajah Crescent · Singapore 139942
Company Registration No. 199003130E
Tel. +65 67799091 · Fax +65 68731637
E-mail: sales@sg.pepperl-fuchs.com

pf PEPPERL+FUCHS

Subject to reasonable modifications due to technical advances
Copyright PEPPERL+FUCHS • Printed in Germany



SCATTERGOOD & JOHNSON LTD

ELECTRICAL ENGINEERING & FLUID CONTROL DISTRIBUTORS

Est.1899

At Scattergood & Johnson Ltd, we pride ourselves on being a technical distributor to specialist industries.

Working with a range of quality product suppliers across a number of specialist markets, we are not your average 'box shifter' - we are your technical and supply chain partner.

We fully support every product we sell - for free! Our internal team and external sales engineers can answer any product or application question, no matter the complexity.

Backing up this technical ability is a range of 50,000+ products available from stock for nationwide next day delivery (same day if required!), or you can collect what you need from any of our trade counters around the UK.

Select your specialist interest below to learn more about how we can help.

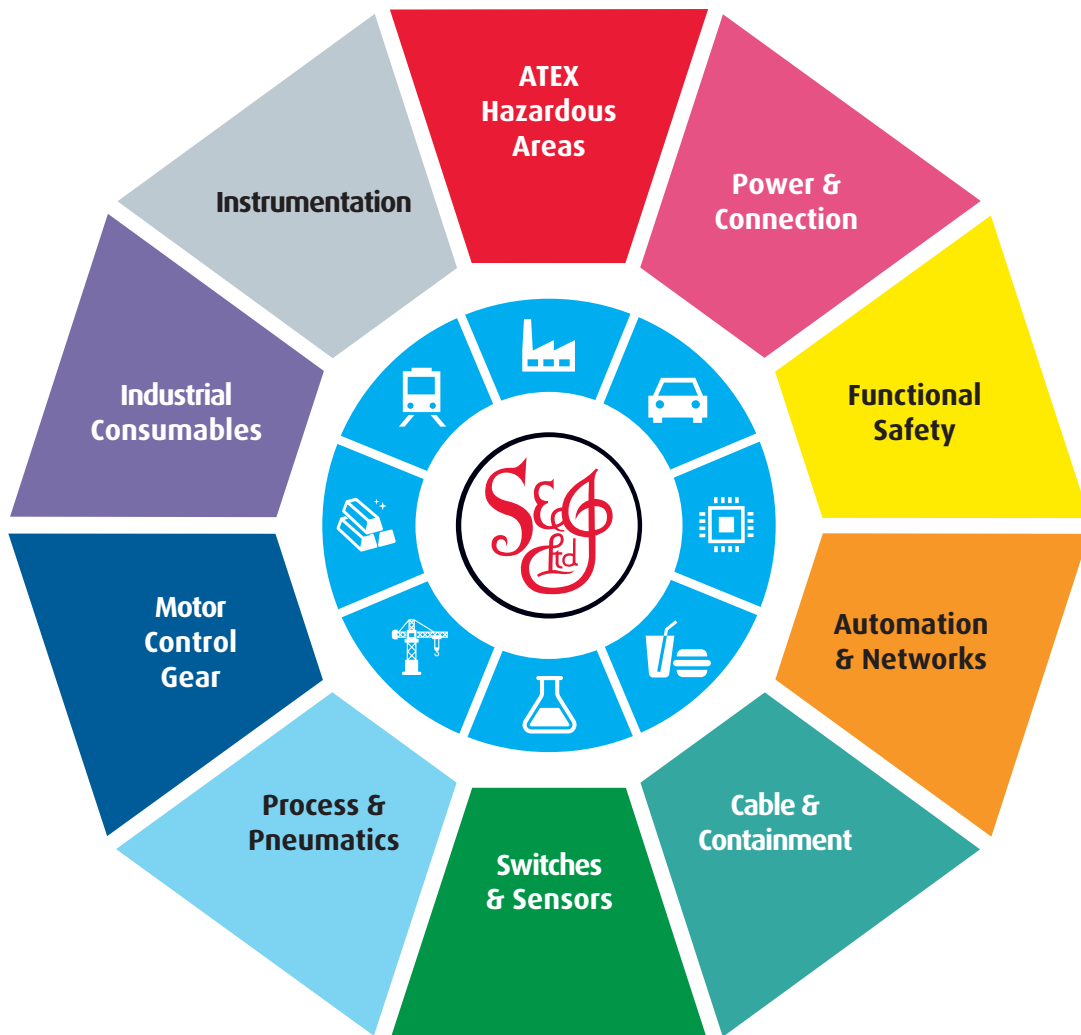

Online, In Branch and On the Road - Scattergood & Johnson Ltd, there when you need us.

www.scatts.co.uk