



# FFUS15-1G1IO

FFU

FLOW SENSORS

**SICK**  
Sensor Intelligence.



Illustration may differ



### Ordering information

Type	Part no.
FFUS15-1G1IO	6041249

Other models and accessories → [www.sick.com/FFU](http://www.sick.com/FFU)

### Detailed technical data

#### Features

<b>Measurement principle</b>	Ultrasonic sensor
<b>Medium</b>	Fluids
<b>Nominal width measuring tube</b>	DN 15
<b>Process temperature</b>	0 °C ... +80 °C
<b>Process pressure</b>	Max. 16 bar

#### Performance

<b>Minimum flow</b>	≥ 0.9 l/min <sup>1)</sup>
<b>Maximum flow</b>	0 l/min ... 36 l/min
<b>Inlet zone</b>	30 cm
<b>Output zone</b>	5 cm
<b>Conductivity</b>	No limitation
<b>Accuracy of sensor element</b>	2 % of final value <sup>2)</sup>
<b>Reproducibility</b>	≤ 0.5 %
<b>Resolution</b>	0.006 l/min

<sup>1)</sup> At constant flow rate.

<sup>2)</sup> Reference condition: Water, zero gas, measuring tube completely full, no cavitation, temperature of medium 20 °C, ambient temperature 20 °C ... 25 °C, compliance with inlet and outlet zones, warm-up time for electronics: 30 min.

#### Electronics

<b>Supply voltage</b>	18 V DC ... 30 V DC <sup>1)</sup>
<b>Residual ripple</b>	≤ 5 V <sub>pp</sub> <sup>2)</sup>
<b>Power consumption</b>	≤ 180 mA <sup>3)</sup>
<b>Initialization time</b>	≤ 5 s
<b>Protection class</b>	III
<b>Connection type</b>	Round connector M12 x 1, 5-pin

<sup>1)</sup> All connections are polarity protected. All outputs are overload and short-circuit protected.

<sup>2)</sup> May not exceed or fall below U<sub>v</sub> tolerances.

<sup>3)</sup> Without load.

<sup>4)</sup> There are 100 mA for each output PNP and NPN available.

<sup>5)</sup> Analog output and display.

<b>Output signal</b>	Analog output 4 mA ... 20 mA, 0 mA ... 20 mA current flow and temperature <sup>1)</sup> 1 pulse/status output PNP/NPN-transistor output for flow rate meter, empty pipe detection, flow monitoring, dosing output, flow direction (dependent on type)
<b>Output current</b>	< 100 mA <sup>4)</sup>
<b>Output load</b>	< 500 Ohm
<b>Lower signal level</b>	3.8 mA ... 4 mA
<b>Upper signal level</b>	20 mA ... 20.5 mA
<b>Impuls/frequency output</b>	0 kHz ... 10 kHz
<b>Puls width</b>	≤ 1 s
<b>Signal voltage HIGH</b>	V <sub>s</sub> - 2 V
<b>Signal voltage LOW</b>	≤ 2 V
<b>Inductive load</b>	1 H
<b>Capacitive load</b>	100 nF
<b>Response time</b>	Filter off 100 ms, filter low 300 ms, filter medium 1 s, filter strong 4.2 s <sup>5)</sup>

<sup>1)</sup> All connections are polarity protected. All outputs are overload and short-circuit protected.

<sup>2)</sup> May not exceed or fall below U<sub>y</sub> tolerances.

<sup>3)</sup> Without load.

<sup>4)</sup> There are 100 mA for each output PNP and NPN available.

<sup>5)</sup> Analog output and display.

## Mechanics

<b>Process connection</b>	G ¾
<b>Wetted parts</b>	PPSU
<b>Housing material</b>	PPSU
<b>Enclosure rating</b>	IP67
<b>Weight</b>	350 g

## Ambient data

<b>Ambient operating temperature</b>	0 °C ... +60 °C
<b>Ambient storage temperature</b>	-20 °C ... +70 °C

## Classifications

<b>ECl@ss 5.0</b>	27371815
<b>ECl@ss 5.1.4</b>	27371815
<b>ECl@ss 6.0</b>	27371815
<b>ECl@ss 6.2</b>	27371815
<b>ECl@ss 7.0</b>	27371815
<b>ECl@ss 8.0</b>	27371815
<b>ECl@ss 8.1</b>	27371815
<b>ECl@ss 9.0</b>	27371815
<b>ECl@ss 10.0</b>	27371815
<b>ECl@ss 11.0</b>	27371815
<b>ETIM 5.0</b>	EC002580
<b>ETIM 6.0</b>	EC002580
<b>ETIM 7.0</b>	EC002580

UNSPSC 16.0901

41112501

### Dimensional drawing (Dimensions in mm (inch))

DN 15, G 3/4

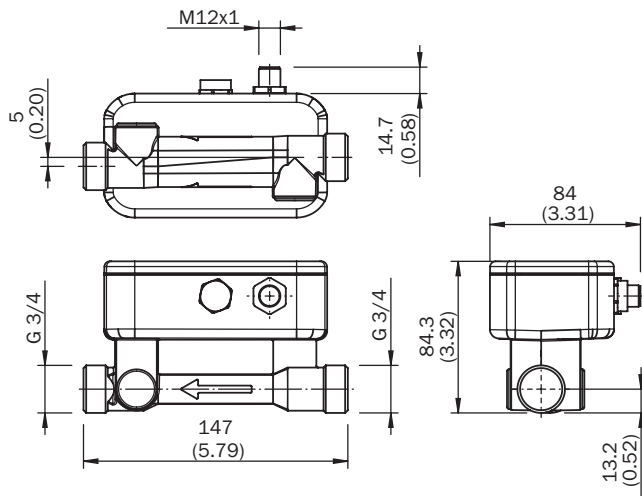

### Connection type

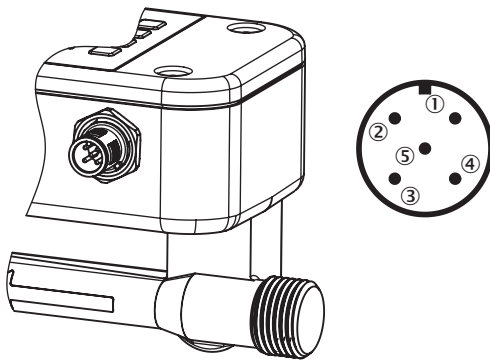

- ① L<sup>+</sup>: Supply voltage
- ② Q<sub>1</sub>: Digital output PNP/NPN
- ③ M: Ground
- ④ C: Communication
- ⑤ Q<sub>A</sub>: Analog current output

## SICK AT A GLANCE

SICK is one of the leading manufacturers of intelligent sensors and sensor solutions for industrial applications. A unique range of products and services creates the perfect basis for controlling processes securely and efficiently, protecting individuals from accidents and preventing damage to the environment.

We have extensive experience in a wide range of industries and understand their processes and requirements. With intelligent sensors, we can deliver exactly what our customers need. In application centers in Europe, Asia and North America, system solutions are tested and optimized in accordance with customer specifications. All this makes us a reliable supplier and development partner.

Comprehensive services complete our offering: SICK LifeTime Services provide support throughout the machine life cycle and ensure safety and productivity.

For us, that is “Sensor Intelligence.”

## WORLDWIDE PRESENCE:

Contacts and other locations –[www.sick.com](http://www.sick.com)