



# LFH-SB1X0G1AS20SZ0

LFH

PRESSURE SENSORS

**SICK**  
Sensor Intelligence.



Illustration may differ



### Ordering information

Type	Part no.
LFH-SB1X0G1AS20SZ0	6040952

Other models and accessories → [www.sick.com/LFH](http://www.sick.com/LFH)

### Detailed technical data

#### Features

<b>Medium</b>	Fluids
<b>Pressure type</b>	Gauge pressure
<b>Pressure unit</b>	bar
<b>Measuring range</b>	0 bar ... 1 bar
<b>Process temperature</b>	-10 °C ... +50 °C
<b>Output signal</b>	4 mA ... 20 mA, 2-wire
<b>Length of cable</b>	20 m

#### Mechanics/electronics

<b>Wetted parts</b>	Housing: Stainless steel Pressure connection/diaphragm: CrNi steel Protection cap: PA
<b>Connection type</b>	PUR cable
<b>Supply voltage</b>	10 V DC ... 30 V DC 14 V DC ... 30 V DC with output signal 0 V ... 10 V (only with enhanced variant)
<b>Electrical safety</b>	Protection class: III Short-circuit protection: Q <sub>A</sub> towards M Reverse polarity protection: L <sup>+</sup> to M Surge protection: According to EN 61000-4-5 (1.5 J) optional for enhanced variant
<b>Dielectric strength</b>	500 V DC, NEC Class O2 power supply (low voltage and low current max. 100 VA even in the event of a fault)
<b>CE-conformity</b>	EMC directive: 2014/30/EU, EN 61 326-2-3
<b>Weight sensor</b>	0.18 kg
<b>Cable weight</b>	0.08 kg/m
<b>Enclosure rating</b>	IP68
<b>Protection class III</b>	✓

#### Performance

<b>Non-linearity</b>	≤ ± 0.2 %, of span (Best Fit Straight Line, BFSL) according to IEC 61298-2
<b>Accuracy</b>	≤ ± 0.5 % of the span
<b>Non-repeatability</b>	≤ ± 0.1 % of the span
<b>Long-term drift/one-year stability</b>	≤ ± 0.2 % of span (at reference conditions)

<b>Temperature coefficient in rated temperature range</b>	Mean TC of zero: $\leq 0.2\%$ of span / 10 K ( $< 0.4\%$ for pressure ranges $\leq 0.25$ bar), Mean TC of span $\leq 0.2\%$ of span / 10 K
<b>Rated temperature range</b>	0 °C ... +50 °C

Ambient data

<b>Storage temperature</b>	-30 °C ... +80 °C
----------------------------	-------------------

Classifications

<b>ECl@ss 5.0</b>	27200506
<b>ECl@ss 5.1.4</b>	27200506
<b>ECl@ss 6.0</b>	27200506
<b>ECl@ss 6.2</b>	27200506
<b>ECl@ss 7.0</b>	27200506
<b>ECl@ss 8.0</b>	27200506
<b>ECl@ss 8.1</b>	27200506
<b>ECl@ss 9.0</b>	27200506
<b>ECl@ss 10.0</b>	27200506
<b>ECl@ss 11.0</b>	27200506
<b>ETIM 5.0</b>	EC001846
<b>ETIM 6.0</b>	EC001846
<b>ETIM 7.0</b>	EC001846
<b>UNSPSC 16.0901</b>	41111950



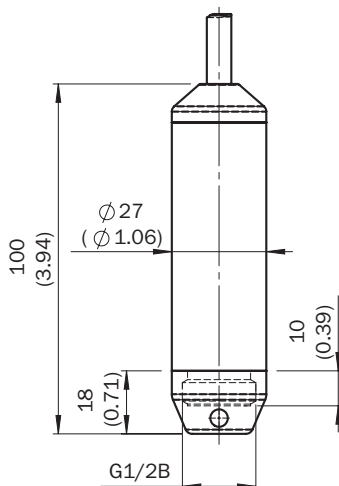

Dimensional drawing (Dimensions in mm (inch))

Standard version (Immersion depth up to 100 m)



### Recommended accessories

Other models and accessories → [www.sick.com/LFH](http://www.sick.com/LFH)

	Brief description	Type	Part no.
<b>Other mounting accessories</b>			
	Additional weight for stabilizing the LFH level sensor in moving liquids. Interior process connection G 1/2, is fastened to the level sensor instead of the protective cap. Weight: 500 g., Stainless steel 1.4571	BEF-AW-LFHSST-0001	5324308
<b>Terminal and alignment brackets</b>			
	Cable tension clamp for mounting the connection cable of the level sensor, max. tensile load = 2.5 kN (not to be used with FEP cable), steel, zinc coated, plastic	BEF-CC-LFH001-0001	5324307
<b>Adapters and distributors</b>			
	Dimensions (W x D x H) 57 mm x 130 mm x 94 mm, for electrical connection of level probe LFH	ASK-CB-LFH-PCO-0001	5324310
<b>Protection filter</b>			
	Protection filter for connection cable. Prevents humidity from entering the ventilation tube of the connection cable. For self-mounting at cable end.	APR-VF-LFH001-0001	5324309

## SICK AT A GLANCE

SICK is one of the leading manufacturers of intelligent sensors and sensor solutions for industrial applications. A unique range of products and services creates the perfect basis for controlling processes securely and efficiently, protecting individuals from accidents and preventing damage to the environment.

We have extensive experience in a wide range of industries and understand their processes and requirements. With intelligent sensors, we can deliver exactly what our customers need. In application centers in Europe, Asia and North America, system solutions are tested and optimized in accordance with customer specifications. All this makes us a reliable supplier and development partner.

Comprehensive services complete our offering: SICK LifeTime Services provide support throughout the machine life cycle and ensure safety and productivity.

For us, that is “Sensor Intelligence.”

## WORLDWIDE PRESENCE:

Contacts and other locations –[www.sick.com](http://www.sick.com)