



UC12-11231

UC12

ULTRASONIC SENSORS

SICK
Sensor Intelligence.



Ordering information

Type	Part no.
UC12-11231	6029831

Other models and accessories → www.sick.com/UC12



Detailed technical data

Mechanics/electronics

Supply voltage V_s	DC 10 V ... 30 V ¹⁾
Power consumption	≤ 1.2 W ²⁾
Initialization time	< 300 ms
Design	Rectangular
Housing material	Die-cast zinc Ultrasonic transducer: polyurethane foam, glass epoxy resin
Connection type	Male connector, M12, 4-pin
Indication	Dual LED
Weight	75 g
Sending axis	Straight
Enclosure rating	IP65 / IP67
Protection class	III

¹⁾ Limit values, reverse-polarity protected, operation in short-circuit protected network: max. 8 A.

²⁾ Without load.

Performance

Operating range, limiting range	20 mm ... 150 mm, 250 mm
Target	Natural objects
Resolution	≥ 0.1 mm
Repeatability	± 0.15 % ¹⁾
Accuracy	± 1 % ¹⁾
Temperature compensation	✓
Response time	30 ms
Switching frequency	25 Hz
Output time	8 ms

¹⁾ Referring to current measurement value.

Ultrasonic frequency (typical)	380 kHz
Detection area (typical)	See diagrams
Additional function	Set switching mode: Distance to object (DtO) / Window (Wnd) / Object between sensor and background (ObSB), teach-in of digital output, teach-in button(s) (can be deactivated), reset to factory default

¹⁾ Referring to current measurement value.

Interfaces

Digital output	Number	2 ¹⁾
	Type	PNP
	Function	Complementary digital outputs (Q, \bar{Q})
	Maximum output current I_A	≤ 500 mA
Hysteresis		2 mm

¹⁾ PNP: HIGH = $V_S - (< 2 \text{ V})$ / LOW = 0 V.

Ambient data

Ambient temperature operation	-25 °C ... +70 °C
Ambient storage temperature	-40 °C ... +85 °C

Classifications

ECl@ss 5.0	27270804
ECl@ss 5.1.4	27270804
ECl@ss 6.0	27270804
ECl@ss 6.2	27270804
ECl@ss 7.0	27270804
ECl@ss 8.0	27270804
ECl@ss 8.1	27270804
ECl@ss 9.0	27270804
ECl@ss 10.0	27270804
ECl@ss 11.0	27270804
ETIM 5.0	EC001846
ETIM 6.0	EC001846
ETIM 7.0	EC001846
UNSPSC 16.0901	41111960

Dimensional drawing (Dimensions in mm (inch))

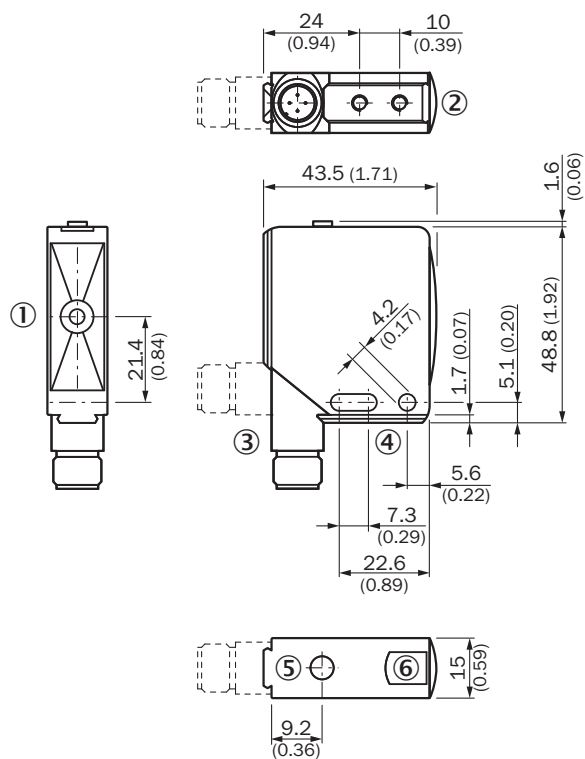

- ① Sender and receiver axis
- ② M4 threaded mounting hole, 4 mm deep
- ③ Connection
- ④ Fixing hole
- ⑤ Operating elements
- ⑥ Status indicator digital output (orange) and power on (green)

Connection type

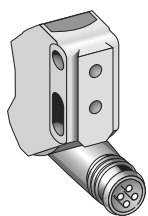

Connection diagram

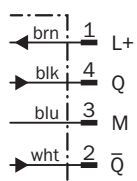

Adjustment possible

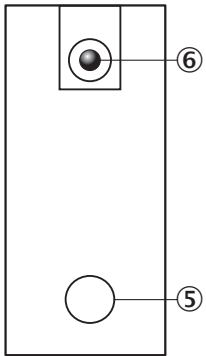

- ⑤ Operating elements
- ⑥ Status display of the digital output (orange) and supply voltage active (green)

Detection area

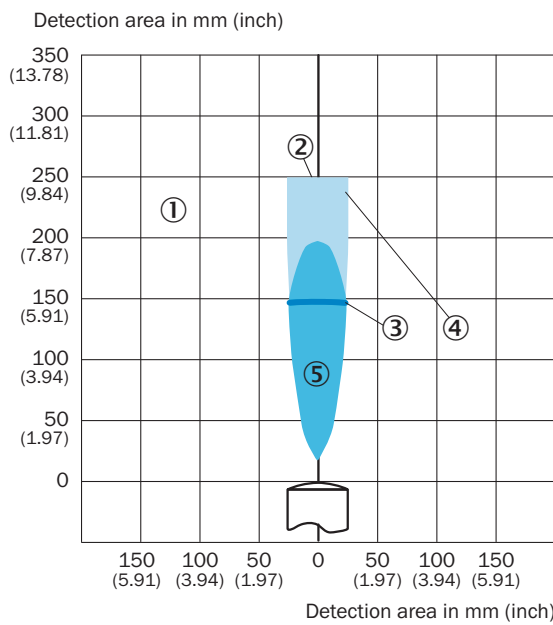

UC12-11



- ① Detection range dependent on reflection properties, size, and alignment of the object
- ② Limiting range
- ③ Operating range
- ④ Example object: aligned plate 10 mm x 10 mm
- ⑤ Example object: cylindrical bar with a diameter of 10 mm

Recommended accessories

Other models and accessories → www.sick.com/UC12

	Brief description	Type	Part no.
Mounting brackets and plates			
	Mounting bracket, small, stainless steel, mounting hardware included	BEF-WK-W12	2012938
Plug connectors and cables			
	Head A: female connector, M12, 5-pin, straight, A-coded Head B: Flying leads Cable: Sensor/actuator cable, PVC, unshielded, 2 m	YF2A15-020VB5XLEAX	2096239

Recommended services

Additional services → www.sick.com/UC12

	Type	Part no.
Warranty extensions		
<ul style="list-style-type: none"> • Product area: Identification solutions, machine vision, Distance sensors, Detection and ranging solutions • Range of services: The services correspond to the scope of the statutory manufacturer warranty (SICK general terms and conditions of purchase) • Duration: Five-year warranty from date of purchase. 	Five-year extended warranty	1680671

SICK AT A GLANCE

SICK is one of the leading manufacturers of intelligent sensors and sensor solutions for industrial applications. A unique range of products and services creates the perfect basis for controlling processes securely and efficiently, protecting individuals from accidents and preventing damage to the environment.

We have extensive experience in a wide range of industries and understand their processes and requirements. With intelligent sensors, we can deliver exactly what our customers need. In application centers in Europe, Asia and North America, system solutions are tested and optimized in accordance with customer specifications. All this makes us a reliable supplier and development partner.

Comprehensive services complete our offering: SICK LifeTime Services provide support throughout the machine life cycle and ensure safety and productivity.

For us, that is “Sensor Intelligence.”

WORLDWIDE PRESENCE:

Contacts and other locations –www.sick.com