

A

B

C

D

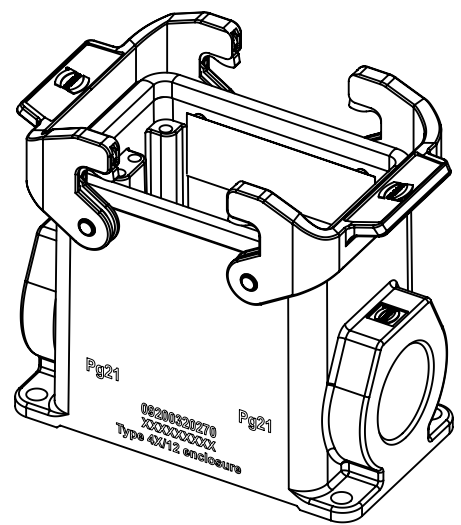
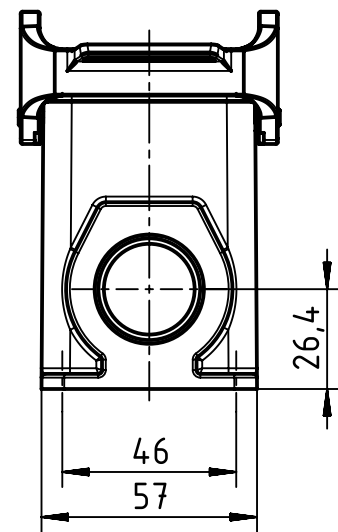
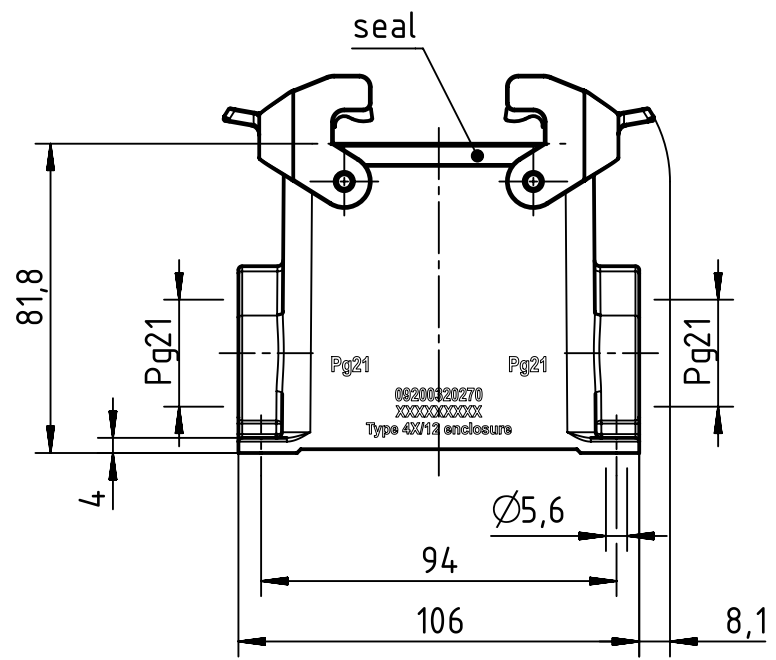

	All Dimensions in mm Original Size DIN A4		Scale 1:2	Free size tol.	Ref. Sub. TB 09 20 032 0270 v. 26.01.11		
		All rights reserved	Created by HELLMANN	Inspected by GERB	Standardisation GARSKE	Date 2019-12-02	State Final Release
Department EL PD		Title Han A Base Surface HC 2 Levers 2 Entries			Doc-Key / ECM-Nr. 100206241/UGD/004/B 5000001614.16		
HARTING Electric GmbH & Co. KG D-32339 Espelkamp		Type TB	Number 09 20 032 0270			Rev. B	Page 1/1