

1 2 3 4 5 6



A

B

C

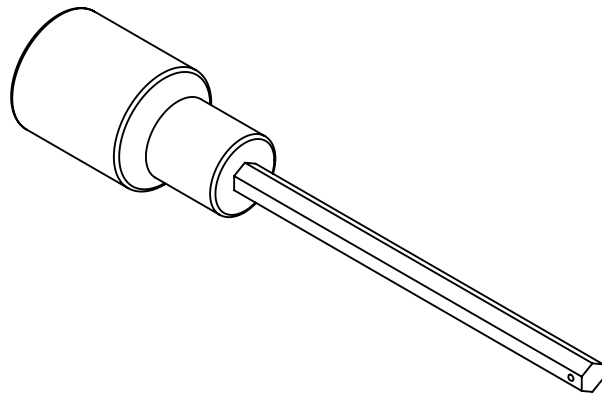
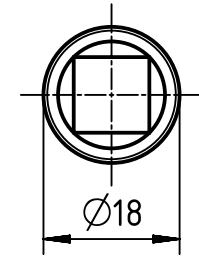
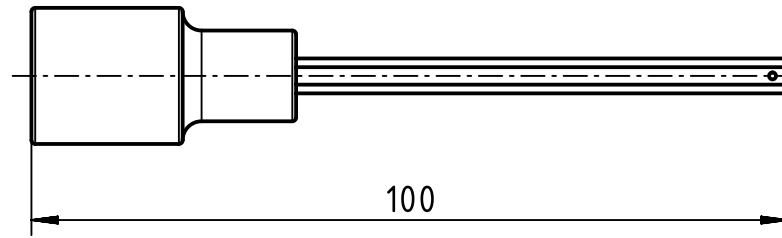
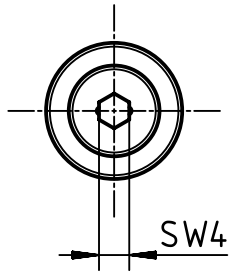
D

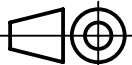

	All rights reserved		Created by FINKEV		Inspected by RIEPE		Standardisation GARSKE		Date 2020-03-26		State Final Release	
	Department EL PD		Title hexagonal wrench adapter SW4		Doc-Key / ECM-Nr. 100090796/UGD/005/A 500000169797		Type TB		Number 09 99 000 0370		Rev. A	
 All Dimensions in mm Original Size DIN A4			Scale 1:1		Free size tol.				Ref.		Sub.	
 HARTING Electric GmbH & Co. KG D-32339 Espelkamp												