



Motorised and automatic transfer enclosed switches

ATyS in enclosure

40 to 3200 A

Integrated products
& solutions



The solution for

- › High-rise buildings
- › Data centers
- › Energy generation
- › Healthcare buildings
- › Banks and insurance companies
- › Transport (airports, tunnels, etc.)



Strong points

- › Quick installation
- › Wide choice
- › Easy maintenance
- › Adaptability

Compliance with standards

- › IEC 60947-3
- › IEC 60947-6,-1
- › IEC 61439-2



Function

Our **transfer enclosures** are equipped with ATyS motorised and automatic changeover switches to ensure power availability in critical applications. Motorised transfer enclosures are controlled manually or remotely through an external automated system. Automated transfer enclosures automatically ensure that power availability is integrally managed.

Advantages

Quick installation

Easy installation with the network auto-configuration feature. All of the auxiliary contacts, inputs and outputs are routed on terminal strips for high rating ATyS models.

Wide choice

ATyS models have specific functions to make your electrical system safer and smarter.

Compatible with all types of BMS/SCADA of your choice. Always know what is happening on your network.

Easy maintenance

ATyS models have maintenance-free arcing contacts. You can also control the device with the emergency lever behind the door.

Adaptability

With a wide range of setup options, our range of enclosed ATyS models are adapted to suit your needs.

ATyS M in polycarbonate enclosure



General features

- From 40 to 160 A.
- Mains 230 VAC [176 VAC-288 VAC] 50 Hz or 60 Hz [45 Hz-65 Hz].
- Bridging bar built-in.
- Mounted auxiliary contact.
- IP rating: IP 41.
- Colour: RAL 7035.
- Fixed at the base of the enclosure.
- Cover closed with 4 screws.

References

ATyS g M three-phase (4 P) model

Rating (A)	References
40	1855 4004
63	1855 4006
80	1855 4008
100	1855 4010
125	1855 4012
160	1855 4016

Dimensions

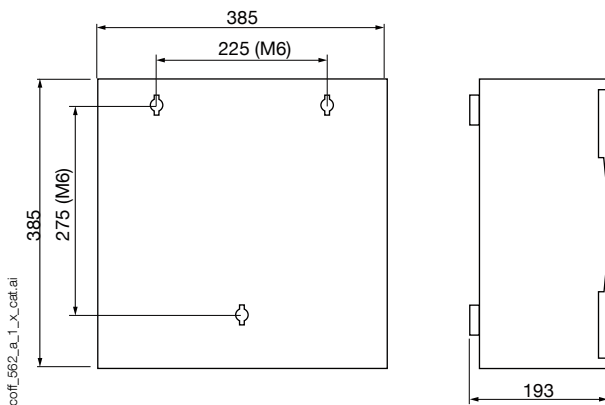

coff_562_a_1_x_cat1ai

Motorised and automatic transfer enclosed switches

ATyS in enclosure

40 to 3200 A

ATyS M in polycarbonate enclosure



General features

- From 40 to 160 A.
- 230 VAC [176 VAC-288 VAC] 50 Hz network or 60 Hz [45 Hz-65 Hz]
- Degree of protection: IP 55, IK08.
- Colour: RAL 7035.
- Material: transparent cover, enclosure base: polycarbonate.
- Mounting: 4 holes on the rear of the enclosure.
- Flame resistant to 650°C.

References

ATyS d M single-phase (2P) model

Rating (A)	References
40	1823 2004
63	1823 2006
80	1823 2008
100	1823 2010
125	1823 2012
160	1823 2016

ATyS g M single-phase (2P) model

Rating (A)	References
40	1854 2004
63	1854 2006
80	1854 2008
100	1854 2010
125	1854 2012
160	1854 2016

Accessories

Customer fit

Designation	References
Auxiliary contact	1309 1001
Voltage sensing and power supply tap (2 for each part)	1399 4006

For model ATyS d M only

Designation	References
ATyS C30 relay driver	1599 3030
ATyS C40 relay driver	1599 3040
Dual power supply	1599 4001

Dimensions

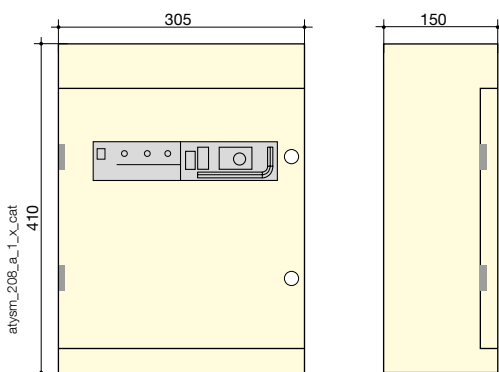

- Weight: 5.5 kg.
- Connection: recommended cable size (Cu): 25 to 70 mm² according to rating (max. cable size: 70 mm²).

ATyS M in steel enclosure



conf_366

General features

- Suitable for environments subject to mechanical risk and dust hazards.
- Bridging bar built-in.
- IP rating: IP3x or IP54.
- Colour: RAL 7035.
- Plates > cables: upstream and downstream.
- Material: 1.2 mm-thick steel.
- Coating: epoxy polyester powder.
- Mounting: 4 wall mounting brackets - not mounted.
- Door: hinged, cutout 327.4 x 47.6 mm.
- Door lock: 3 mm double bar key (included).

References

ATyS d M models

Rating (A)	No. of poles	IP 3X References	IP 54 References
40	4 P	1823 4004	1823 4005
63	4 P	1823 4006	1823 4007
80	4 P	1823 4008	1823 4009
100	4 P	1823 4010	1823 4011
125	4 P	1823 4012	1823 4013
160	4 P	1823 4016	1823 4017

ATyS g M models

Rating (A)	No. of poles	IP 3X References	IP 54 References
40	4 P	1854 4004	1854 4005
63	4 P	1854 4006	1854 4007
80	4 P	1854 4008	1854 4009
100	4 P	1854 4010	1854 4011
125	4 P	1854 4012	1854 4013
160	4 P	1854 4016	1854 4017

ATyS p M + COM RS485 models

Rating (A)	No. of poles	IP 3X References	IP 54 References
40	4 P	1884 4004	1884 4005
63	4 P	1884 4006	1884 4007
80	4 P	1884 4008	1884 4009
100	4 P	1884 4010	1884 4011
125	4 P	1884 4012	1884 4013
160	4 P	1884 4016	1884 4017

Accessories

Customer fit

Designation	References
Conducting neutral	1309 9008
Kit IP54	1399 4016

Dimensions

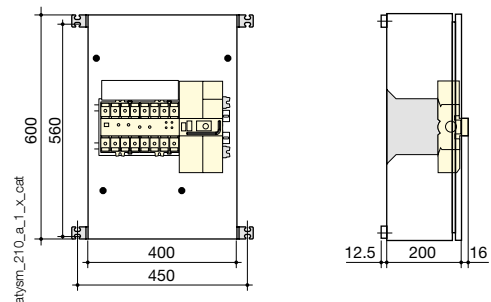

- Weight (without accessories): 15 kg.
- Connection (without cage/terminal interface): min. Cu 10 mm², max. 70 mm².

Motorised and automatic transfer enclosed switches

ATyS in enclosure

40 to 3200 A

ATyS S in steel enclosure



General features

- ATyS S and ATyS d S, 40 to 125 A.
- Protection degree IP3X (IP54 optional extra).
- Colour: RAL 7035, epoxy polyester powder.
- Mounting: 4 wall-mounting brackets (not fitted).
- Material: XC steel, thickness 1.2 mm.
- Closing plate: top and bottom.
- Connection of cables: top or bottom.
- Locking device: 3 mm double bar (key included)
- Mains 230/400 VAC, 50/60 Hz \pm 30%.
- Two power supply versions: 12 VDC (ATyS S) and 2 x 230 VAC (ATyS d S).
- Manual emergency operating handle provided with the enclosure.
- Connection kit.
- Position and live voltage LEDs (factory-fit option).
- Priority source and mode selection (factory-fit option - for use with ATyS C30 option).
- Kit for three-phase networks without neutral (factory-fit option).
- Battery charger kit (factory-fit option).

References

Standard product - ATyS S power supply 12 VDC

Rating (A)	No. of poles	References
40	4 P	3505 4004
63	4 P	3505 4006
80	4 P	3505 4008
100	4 P	3505 4010
125	4 P	3505 4012

Standard product - ATyS d S power supply 230 VAC

Rating (A)	No. of poles	References
40	4 P	3513 4004
63	4 P	3513 4006
80	4 P	3513 4008
100	4 P	3513 4010
125	4 P	3513 4012

Accessories

Factory fitted

Designation	References
Source (voltage) present LEDs	9599 0005
Position LEDs	9599 0006
TEST/AUTO mode selection (with ATyS C30 option)	9599 0007
Priority source selection (with ATyS C30 option)	9599 0008
Surge protection device (SURGYS D40)	9599 0010
Three-phase without neutral	9599 0012
(3Ph+N) 16A auxiliary supply protection kit	9599 0016
Connection kit	9599 0019
Kit IP54	9599 0020
IPXXB protection screen (open door)	9599 0021
Battery charger	9599 0024
Kit for voltage sensing on terminals	9599 0028
Auxiliary contacts prewired to connection terminal	9599 0029
Control/command kit ATyS C30	9599 0030

Customer fit

Designation	References
Connection kit	9599 0018
Kit IP54	9599 0020
IPXXB protection screen (open door)	9599 0021

Characteristics according to IEC 61439-1

Operating voltage	40 A	63 A	80 A	100 A	125 A
Power supply voltage ATyS S (DC)	12 V (9-15 V)				
Power supply voltage ATyS d S (AC)	230 V \pm 30% (160-310 V) 50/60 Hz				
Network operating voltage	415 V (50/60 Hz)				

Rated current

Permissible current (A) at ambient temperature 35°C	40	63	80	100	125
Permissible current (A) at ambient temperature 60°C	40	63	80	100	112

Ambient temperature

Storage	-25 / 70°C
Operation	-25 / 60°C

Dimensions

Rating (A)	Cable cross-section (mm ²)	H (mm)	W (mm)	D (mm)	Weight (kg)
40	10	600	400	200	25
63	16	600	400	200	25
80	25	600	400	200	25
100	35	600	400	200	25
125	50	600	400	200	25

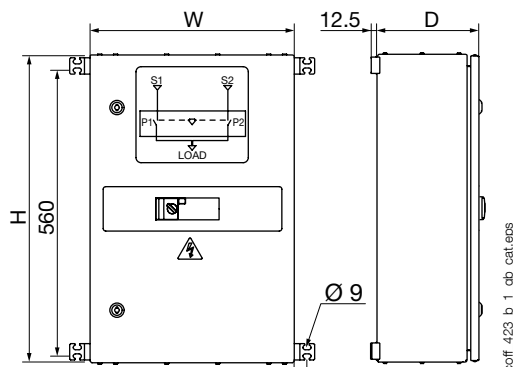

ATyS in steel enclosure



General features

- ATyS r, ATyS g and ATyS p, 200 to 3200 A.
- Suitable for environments subject to mechanical risk and dust hazards.
- IP rating: IP54.
- Colour: RAL 7035.
- Closing plates: bottom.
- Cabling: top or bottom from 200A to 250 A, bottom from 400 to 3200 A.
- 2nd aux contact mounted on the ATyS.
- ATyS g model equipped with an ATyS D10 and ATyS p equipped with an ATyS D20.
- Inputs, outputs and auxiliary contacts mounted on terminals.
- Material: XC steel, thickness 2 mm.
- Coating: epoxy powder.
- Mount: Wall-mounted, supplied brackets not fixed (rating ≤400 A), floor-mounted on feet (rating > 400 A).
- Door: solid with hinges.
- Door lock with 3 mm double bar key included.

References

Rating (A)	Housing size	N° of poles	ATyS r References	ATyS g References	ATyS p References
200	B3	4 P	8723 4020	8753 4020	8773 4020
250	B4		8723 4025	8753 4025	8773 4025
400	B4		8723 4040	8753 4040	8773 4040
630	B5		8723 4063	8753 4063	8773 4063
800	B5		8723 4080	8753 4080	8773 4080
1000	B6		8723 4100	8753 4100	8773 4100
1250	B6		8723 4120	8753 4120	8773 4120
1600	B7		8723 4160	8753 4160	8773 4160
2000	B8		8723 4200	8753 4200	8773 4200
2500	B8		8723 4250	8753 4250	8773 4250
3 200	B8		8723 4320	8753 4320	8773 4320

Accessories

Solid neutral

Rating (A)	References
200	1599 1020
250	1599 1025
400	1599 1040
630	1599 1063
800	1599 1080
1000	1599 1100
1250	1599 1120
1600	1599 1160
2000	Contact us
2500	Contact us
3 200	Contact us

Dimensions

Enclosure, wall-mounted

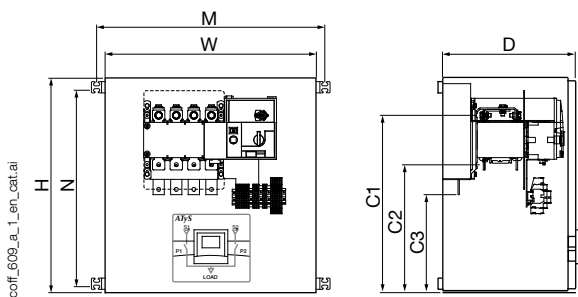

Rating (A)	Recommended CU cable cross-section (mm²)	H (mm)	W (mm)	D (mm)	M (mm)	N (mm)	C1 (mm)	C2 (mm)	C3 (mm)	Weight (kg)
200	95	500	600	300	648	458	342	227	-	27
250	120	500	600	300	648	458	352	222	-	28
400	240	600	600	375	648	548	-	320	250	38

Cabinet, floor-mounted

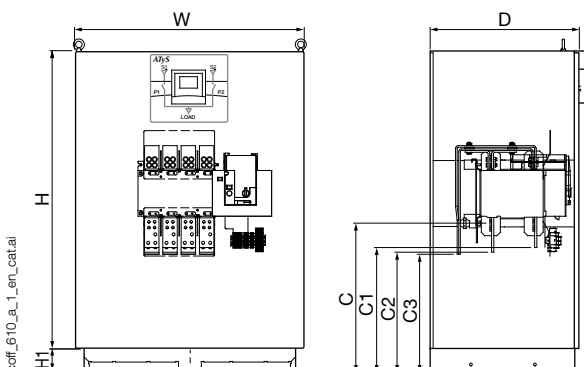

Rating (A)	Recommended CU cable cross-section (mm²)	H (mm)	L (mm)	D (mm)	H1 (mm)	C (mm)	C1 (mm)	C2 (mm)	C3 (mm)	Weight (kg)
630	2 x 185	800	600	475	100	419	-	-	339	91
800	2 x 240	1000	775	650	100	-	402	353	314	120
1000	4 x 150	1000	775	650	100	455	-	-	374	120
1250	4 x 185	1300	1000	650	100	-	660	-	650	265
1600	4 x 240	1500	1000	800	100	-	393	358	307	374
2000	8 x 150	1800	1000	1000	100	-	577-616	517-476	397-436	500
2500	8 x 185	1800	1000	1000	100	-	577-616	517-476	397-436	600
3 200	8 x 240	1800	1000	1000	100	-	577-616	517-476	397-436	600

Motorised and automatic transfer enclosed switches

ATyS in enclosure

40 to 3200 A

Characteristics

Characteristics according to IEC 60947-3, IEC 60947-6-1 and IEC 61439-1

Thermal current I_{th} at 40°C	200 A	250 A	400 A	630 A	800 A	1000 A	1250 A	1600 A	2000 A	2500 A	3200 A	
Rated insulation voltage U_i (V) (power circuit)	800	1000	1000	1000	1000	1000	1000	1000	1000	1000	1000	
Rated impulse withstand voltage U_{imp} (kV) (power circuit)	8	12	12	12	12	12	12	12	12	12	12	
Rated insulation voltage U_i (V) (control circuit)	300	300	300	300	300	300	300	300	300	300	300	
Rated impulse withstand voltage U_{imp} (kV) (command circuit)	4	4	4	4	4	4	4	4	4	4	4	
Rated operational current I_e (A) according to IEC 60947-3												
Rated voltage	Utilisation category	A/B	A/B	A/B	A/B	A/B	A/B	A/B	A/B	A/B	A/B	A/B
415 VAC	AC-21 A / AC-21 B	200/200	250/250	400/400	630/630	800/800	1000/1000	1250/1250	1600/1600	-/2000	-/2500	-/3200
415 VAC	AC-22 A / AC-22 B	200/200	250/250	400/400	630/630	800/800	1000/1000	1250/1250	1600/1600	-/2000	-/2500	-/3200
415 VAC	AC-23 A / AC-23 B	200/200	200/200	400/400	500/630	800/800	1000/1000	1250/1250	1250/1250	-/1600	-/1600	-/1600
Rated operational current I_e (A) according to IEC 60947-6-1												
Rated voltage	Utilisation category											
415 VAC	AC-31 B	200	250	400	630	800	1000	1250	1600	2000	2500	3 200
415 VAC	AC-32 B		200	400	500	800	1000	1250	1250	2000	2000	2000
415 VAC	AC-33 B		200	200	400	800	1000	800	1000	1250	1250	1250
Rated operational current I_e (A) according to IEC 61439-1												
Rated voltage	Ambient air temperature:											
415 VAC	20°C	200	250	400	630	800	1000	1250	1600	2000	2500	3 200
415 VAC	35°C	200	250	400	630	770	1000	1130	1450	2000	2500	2960
415 VAC	50°C	200	250	360	570	695	900	1030	1200	1801	2500	2660
Conditional short-circuit current with gG DIN fuse, according to IEC 60947-3												
Prospective fuse protected short-circuit withstand at 415 VAC (kA rms)		50	50	50	50	50	50	100	100	/	/	/
Connection												
Recommended CU cable cross-section (mm ²)		95	120	240	2 x 185	2 x 240	4 x 150	4 x 185	4 x 240	8 x 150	8 x 185	8 x 240
Power supply												
Min./max. power (VAC)		166/332	166/332	166/332	166/332	166/332	166/332	166/332	166/332	166/332	166/332	166/332
Control supply power demand during transfer												
Demand/rated power (VA) - ATyS r		184/92	276/115	276/115	276/150	276/150	460/184	460/184	460/230	812/322	812/322	812/322
Demand/rated power (VA) - ATyS g , p		206/114	298/137	298/137	298/172	298/172	482/206	482/206	482/252	834/344	834/344	834/344

Choose your equipment

Order the right References

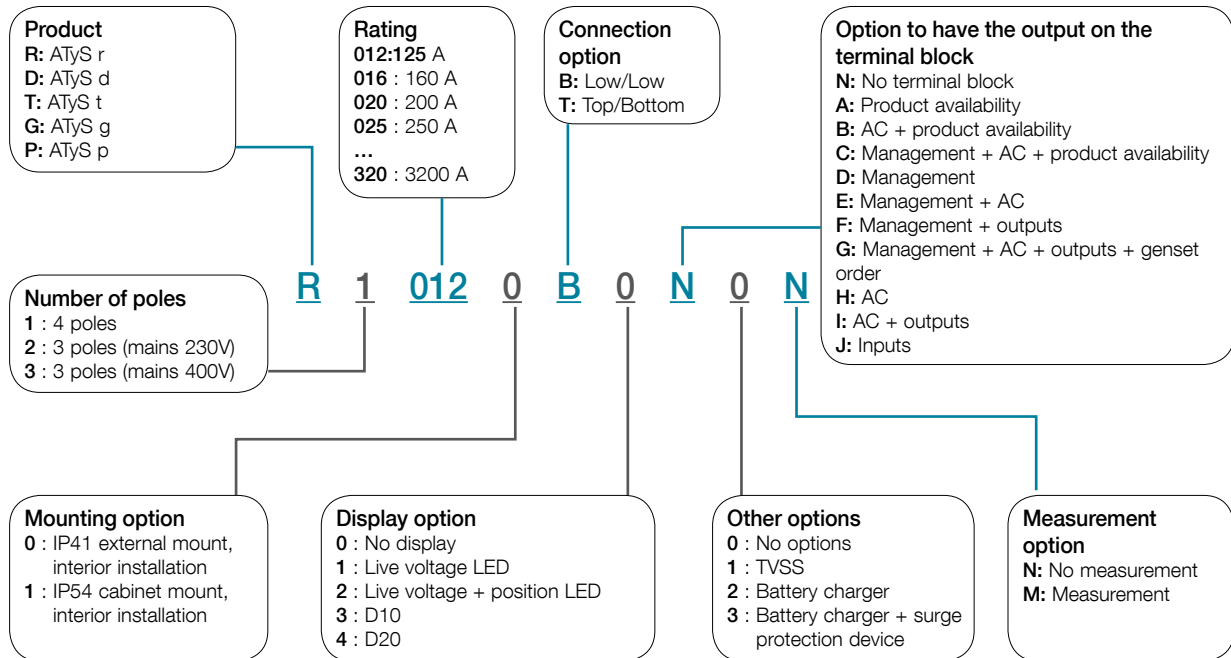

Mounting option

- This option determines the type of mount and the position of the ATyS in the enclosure or cabinet.

Connection option

- This option determines the type of cable connections on your device.

Display option

- This option determines the type of display available at the front of the enclosure. Option compatible only when enclosure is base-mounted.

Option to have the output on the terminal block

- This option determines the connection type for inputs/outputs and auxiliaries on wiring terminals.

Other options

- With this option you can add extra features such as surge protection and/or a genset battery charger.

Measurement option

- This option determines the load current measurement. Option only available on ATyS p.

Delivered equipped and adapted to your needs

- > Socomec can help you decide on the best configuration for your needs.