

# FQ2 VISION SENSOR

The new standard in image inspection and code verification



- » Powerful functionality with versatile line-up
- » crystal clear images
- » All-in-one-housing

# Introducing the FQ2 Vision Sensor Family

*The FQ2 vision sensor family is set to redefine the vision sensor market, providing advanced inspection, code reading and verification only previously available in higher end vision systems. With over 100 camera options, the FQ2 provides users with the ultimate flexibility to solve applications, whether you need high resolution, code reading, integrated lighting, or a cost effective solution to solve a simple application, there is an FQ2 which fits your needs.*



Code Reader	Highspeed image processor	Megapixel capacity	Real colour	Mono-chrome	C-mount	9 inspection items	11 image filters	32 camera expansion	360° position compensation	Ultrawide field of view	DAP partial input
OCR	HDR	Sub-pixel processing	High-power lighting	IP67	E-IP	PLC Link	FINS	34 I/O points	RS-232C	Password	Image inversion

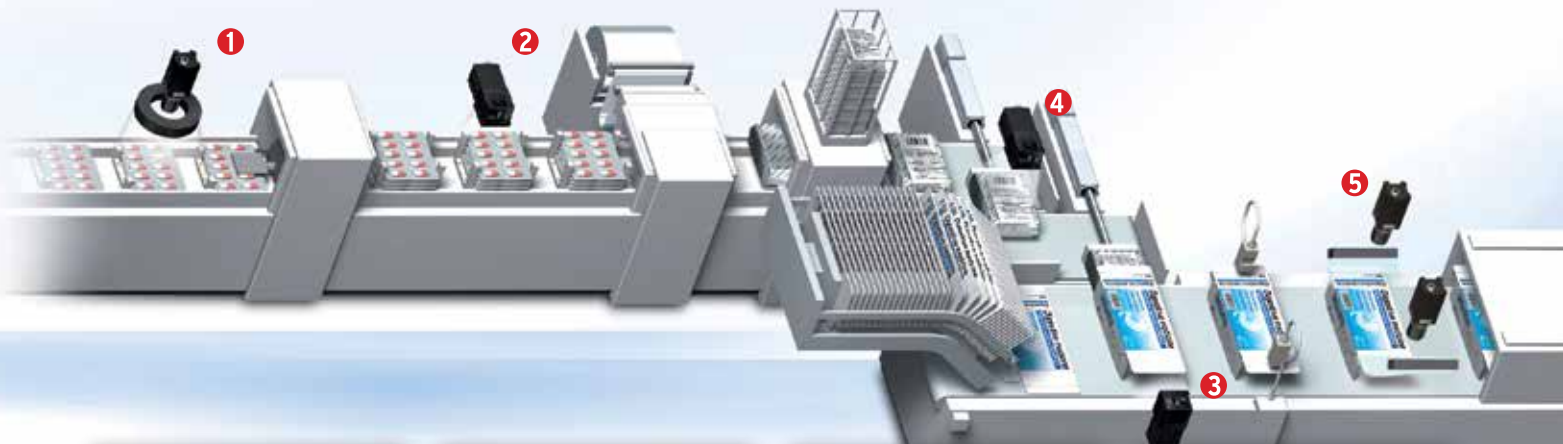

<p><b>NG</b></p> <p><b>1</b></p> <p>Missing Pill</p>	<p><b>NG</b></p> <p><b>2</b></p> <p>Misalignment</p>	<p><b>OK</b></p> <p><b>3</b></p> <p>Package insert detection</p>	<p><b>OK</b></p> <p><b>4</b></p> <p>Reading barcode</p>
------------------------------------------------------	------------------------------------------------------	------------------------------------------------------------------	---------------------------------------------------------

### All-in-one-housing

The compact design of the FQ2 means that it fits easily into confined spaces. Furthermore, unlike conventional vision sensors with multiple components, it comes in a single, all-in-one package.



» p.04

### Advanced Inspection

The FQ2 supports a diverse range of inspection items, including shape search, colour inspection, OCR, code reading and verification.

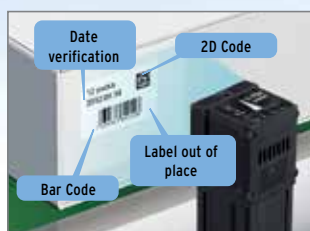

» image inspections p.05  
 » OCR p.08  
 » code reader p.10

### Versatile line-up

Whatever your application, there is an FQ2 to match your requirements, choose the functionality you need, no more and no less!



» p.12

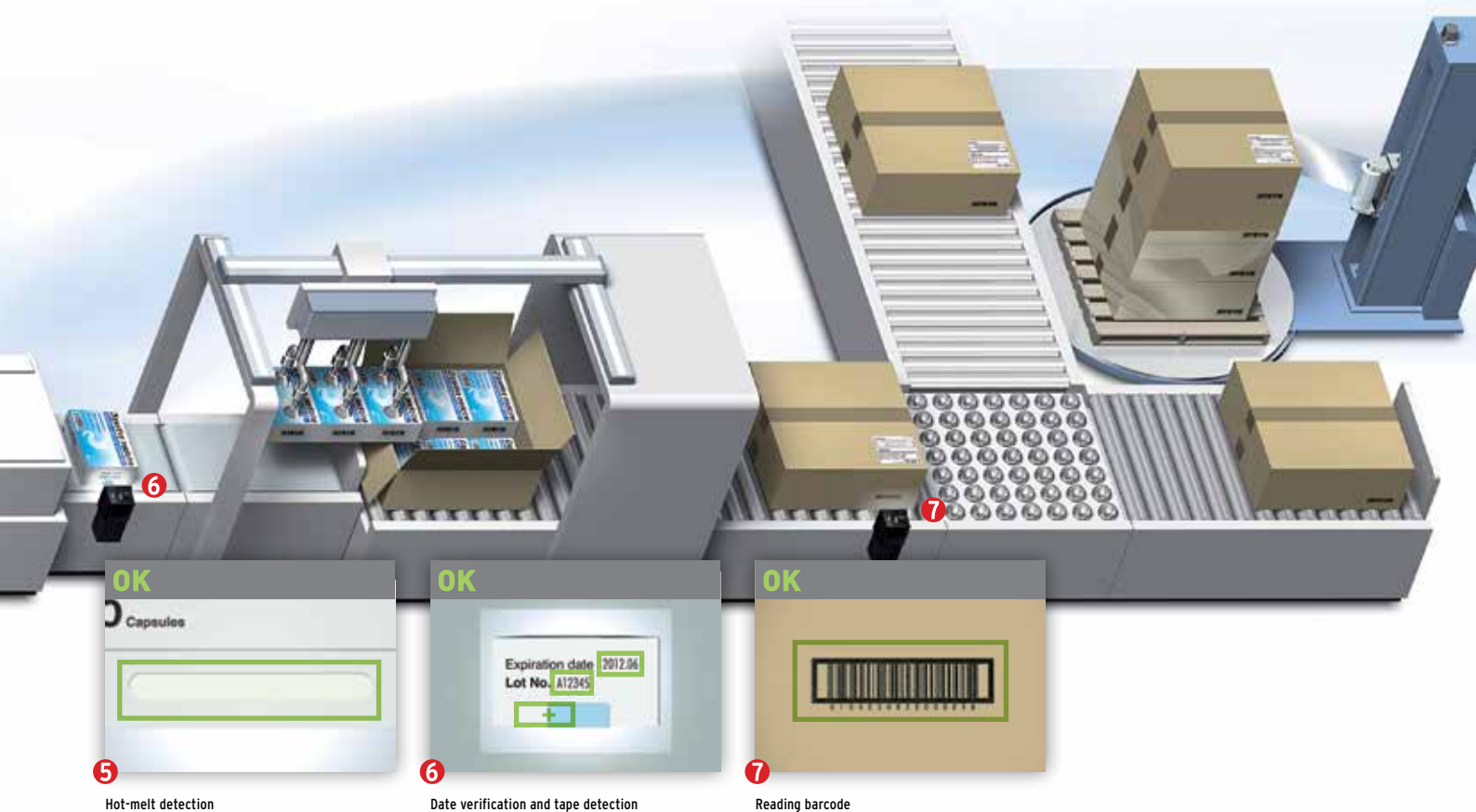

5 Hot-melt detection

6 Date verification and tape detection

7 Reading barcode

# All-in-one-housing

## Easy product selection

Simply select the camera based on the required field-of-view and installation distance. You don't need to purchase additional lighting or lenses and due to there being only two components, systems are faster and far more simple to configure.

## Easy installation

As the camera and lighting have been integrated into a single unit, only one camera mounting bracket is necessary and the requirement for axial alignment is completely eliminated. The multi-directional mounting bracket (provided as standard) can be attached to any of the four sides of the camera.

## Easy expansion

New cameras can simply be installed where and when you need them. No controllers or panels to house them are required and you don't have to worry about timing input issues, as all cameras can be triggered independently. Up to 32 cameras can be set up from a single Touch Finder (see 'Time-saving set-up tools' on page 13), so there is no need to add new monitors when more cameras are added.

### Vision Systems

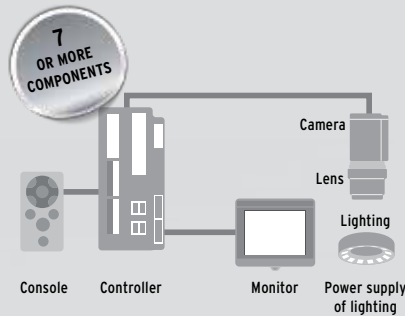

### Current Vision Systems

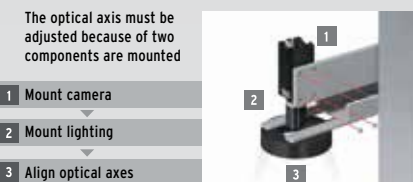

### Current Vision Systems

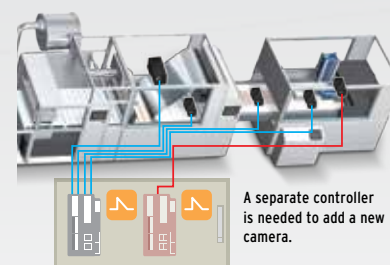

### FQ2-series Smart Cameras



### FQ2-series Smart Cameras

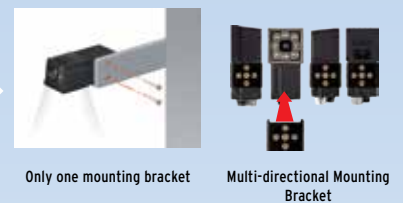

### FQ2-series Smart Cameras



# Advanced platform and innovative features

## Easy inspection and positioning

Multiple inspection and positioning tasks can be performed using a single sensor. The adjacent example shows external inspection of ICs with a single sensor. The position of the entire tray of ICs can be adjusted on the image itself, prior to inspection. This saves you time by reducing the amount of work required to increase the positioning accuracy.

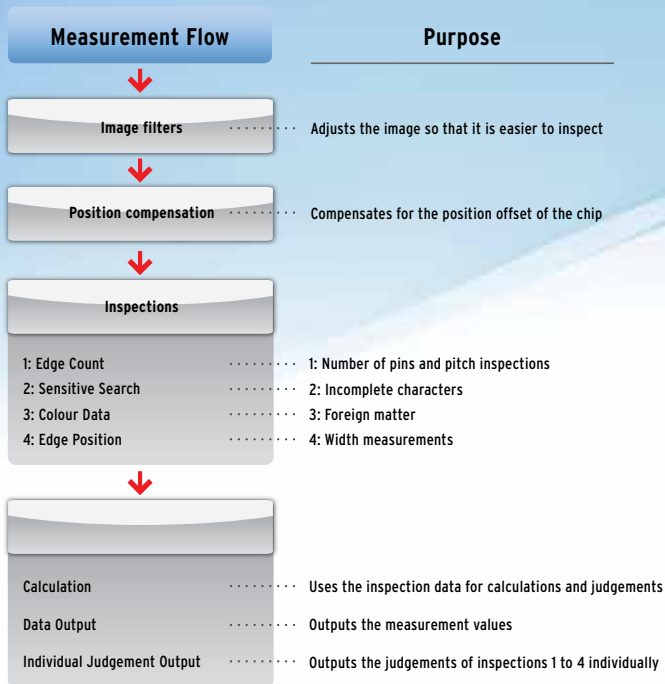
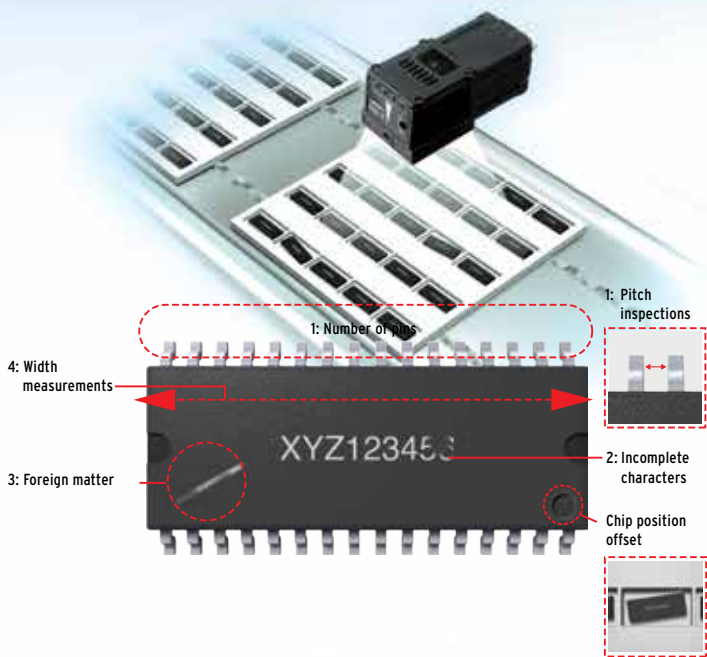

As the sensor can measure angles of rotation and other positional information, it can also be used for positioning. The adjacent example shows an automotive part being inspected for the number and size of holes.

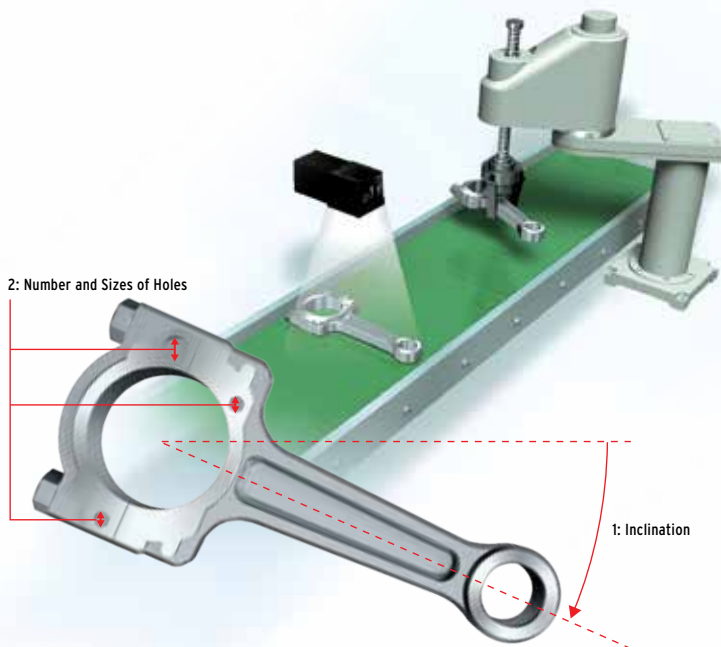
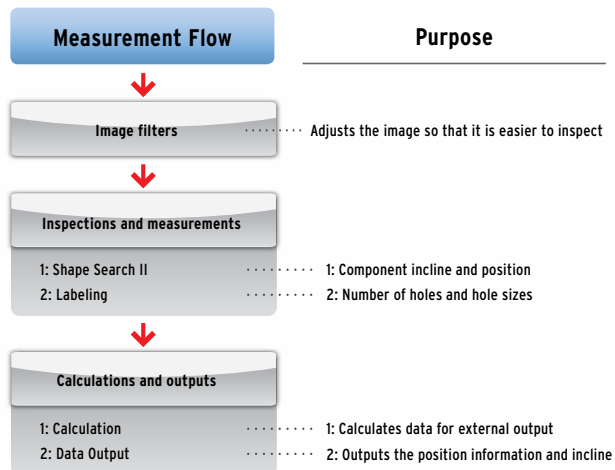

# Easy searching with Shape Search II

Searches are carried out to detect items such as labels and identify shapes or positions. Shape searches generally run into difficulties when it comes to an overlap or 360° rotation. However, the FQ2 achieves high-speed (up to 10 times faster), stable searching of any shapes that match the model. Multiple searches can be performed simultaneously, which enables the inspection of a group of items, e.g. in a tray, or picking applications.

Sensitive searches can also be carried out through automatic division and matching of the model image. This reveals tiny differences that cannot be detected with a normal search.

## SEARCHING

### Shape search II

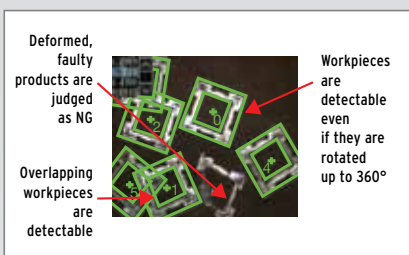

General searches have a difficult time with overlap or 360° rotation, but this Sensor achieves high-speed, stable searching of any shapes that match the model.

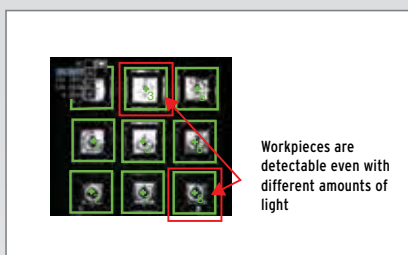

Multiple searches can be performed simultaneously, which enables the inspection of the number of items in a pallet or picking applications.

### Sensitive search

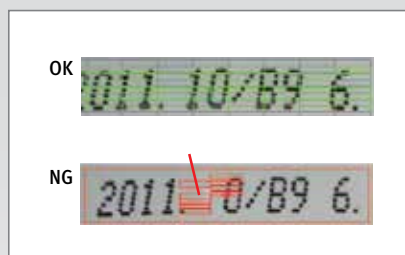

Through automatic division and matching of the model image, tiny differences that cannot be detected with a normal search can be detected with large numerical differences.

## SEARCHING

## EDGE MEASUREMENTS

### Search



This is a standard search inspection item. This type of search is used to detect items like labels, identify shapes, or positions.

### Edge pitch

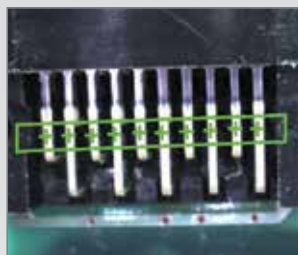

The number of edges in a region can be counted.

### Edge position



This inspection item detects edges and measures their positions.

### Edge width



This inspection item measures the width between edges.

## Stable measurements

A total of 11 different image filters, including background suppression, are provided to stabilize measurements and maximize inspection results. If the dimensions of a workpiece are difficult to determine in a pixel display, the display units can be converted for easier viewing.

### Other measurements possible include:

- Position, width and pitch of edges
- Number, colour, size, area and position of labels
- Colour differences in workpieces
- Inclusion of foreign objects and matter
- Rotational orientation of workpieces

### AREA MEASUREMENTS, COLOUR MEASUREMENTS, AND DEFECT & FOREIGN MATTER DETECTION

#### Labeling



This inspection item counts how many labels there are of the specified colour and size and measures the area or center position of the specified label.

#### Area

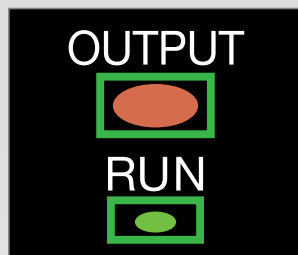

This inspection item measures the area and center position of the specified colour.

#### Colour Data

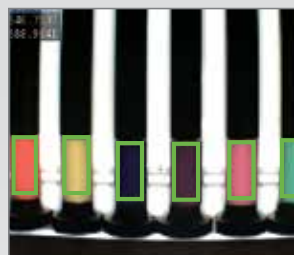

Inspections can be performed that compare the difference in colour between the workpiece and a registered image of a good product to detect objects and foreign matter (average colour value). You can also inspect for defects and foreign matter by looking at the colour deviation (colour deviation).



### UTILITY ITEMS

#### 360° Rotational Position Compensation



The correct position of workpieces with an inconsistent orientation can be measured through automatic detection of the offset of the workpiece in relation to a registered standard model.

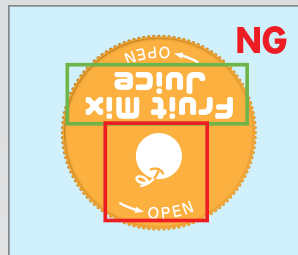

#### Image Filters



One of 11 different image filters is background suppression to help eliminate patterns that can result in unstable measurements, dilation and erosion.

#### Calibration

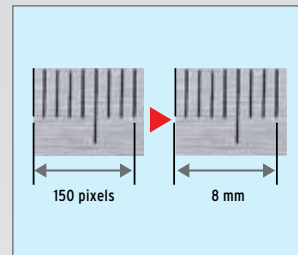

If the dimensions or position of a workpiece is difficult to determine in a pixel display, you can convert the display unit so that it is easier to see.

# Position inspection and character verification

## Stable character reading and verification

Distorted or unclear printing, e.g. due to conveyor-line conditions, is no problem for the FQ2. Stable and fast character reading is assured thanks to the new OCR method and the built-in dictionary. Furthermore, character verification and label-position inspection can both be performed using one FQ2 sensor. This reduces your costs and saves you space.

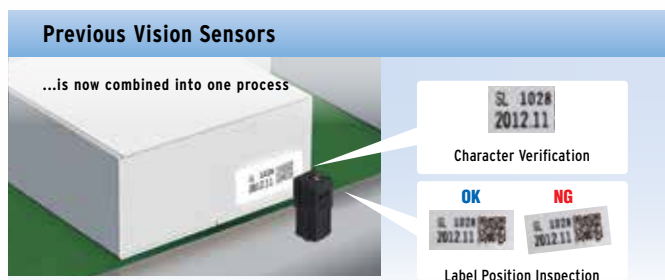
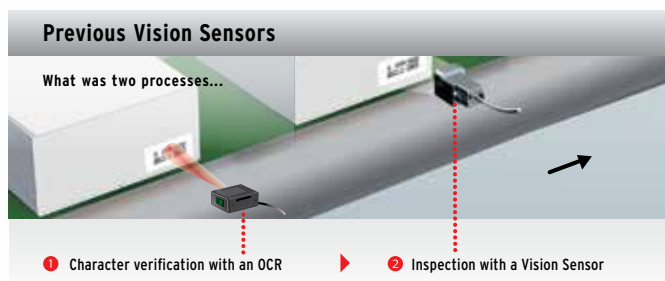
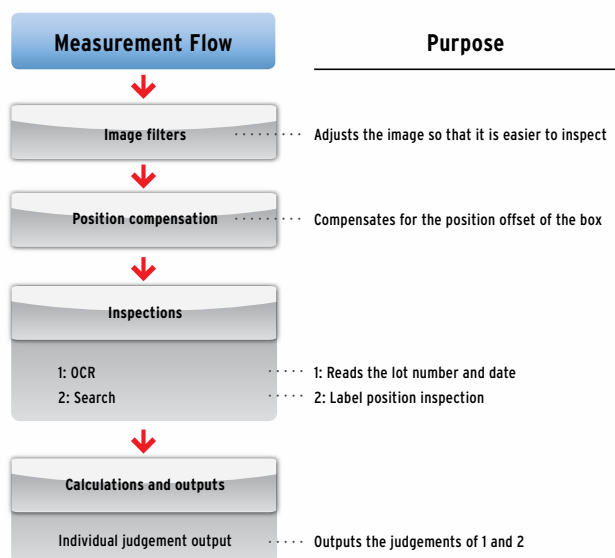
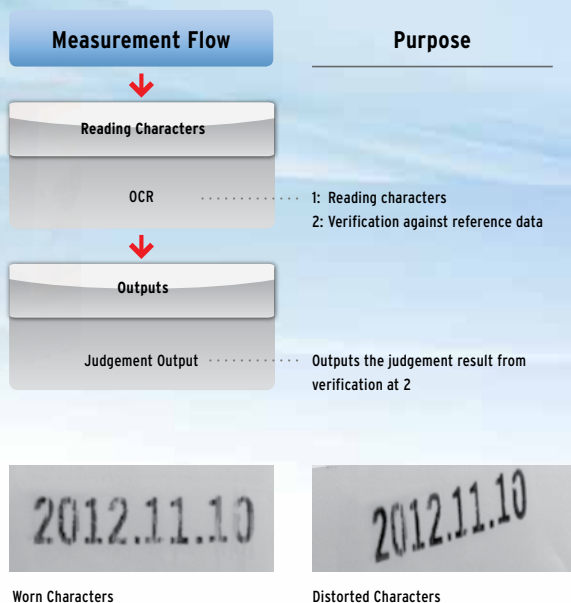

# Unique OCR technology character verification

## With conventional OCR methods:

Character registration in the dictionary requires time, characters printed by different printing devices lead to reading errors, and worn or inclined characters simply can not be read.

**Time is required for character registration in the dictionary**

Step 1: Draw boxes around characters

Step 2: Set the character formats

Step 3: Press the TEACH Button

Step 4: Reading is started

**Character variations by printing technology**

Hot Printer

Inkjet Printer

Thermal Printer

Laser marker

**Worn and inclined characters can not be read**

Worn Characters

Inclined Characters

Small Characters

## With Omron's unique recognition technology:

All of these problems have been overcome with the FQ2. A large, built-in dictionary with approximately 80 different fonts, including worn, blurred and distorted character variations, as well as size and background variations, enables characters from most printers to be read accurately, including inkjet and thermal printers.

Omron's unique recognition technology enables stable recognition of worn or distorted characters and requires no setting of parameters to compensate for character contrast or positional offsetting. No character registration is required because Omron's new OCR algorithm matches the characteristics of each character with structural models.

Structural models record the characteristics of each character in approximately 80 fonts.

The position and structure of characteristic points are used to recognize characters.

Background changes

Size and font changes

Worn and inclined characters

# Code reading and character verification

## Code and character verification / reading made easy

OCR and code reading inspection items can be combined within the FQ2 to read codes and verify them against character strings without any programming of external devices. Due to differences in the various materials involved, codes directly marked on products can cause instability when being read by conventional OCR methods. The FQ2's unique functionality, designed specifically for DPM, overcomes these differences and achieves stable reading.

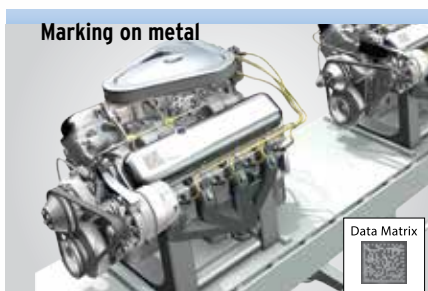
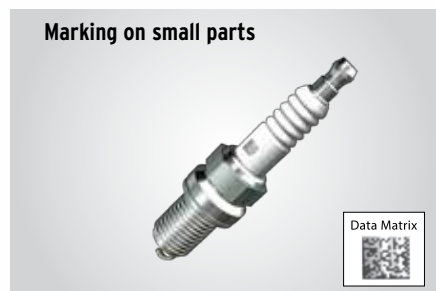
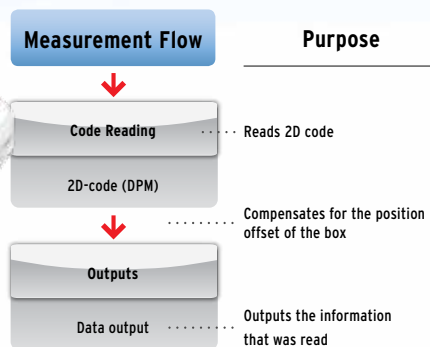
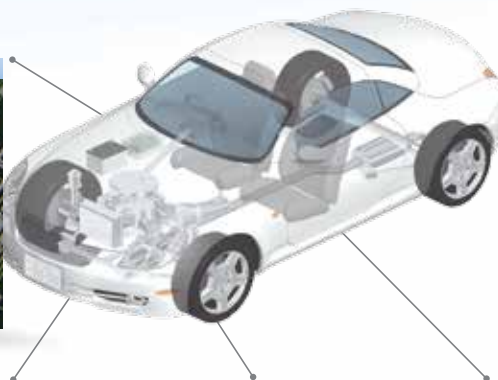
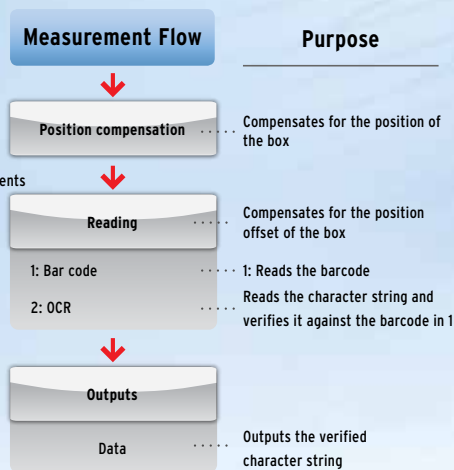

## Paper labels

Where reliable verification of barcodes and characters is required on paper labels, e.g. in the pharmaceuticals industry, the FQ2 is the perfect choice. All commonly used types of barcodes and 2D barcodes can be handled. And only one code reader is required, even when different types of code have to be processed.



## Direct Part Marked (DPM)

2D codes printed directly onto many materials, including metals, substrates, glass, can be difficult to read with good stability. No problem for the FQ2, which is equipped with filters designed specifically for DPM and allow easy and stable reading. Unique, Omron-developed filters also remove printing irregularities and noise, while erosion and dilation can be combined to connect dots on 2D codes without changing the dot thickness.

Types of filtering	
<b>Smooth</b>	Smooths the image
<b>Dilate</b>	For white codes, increases the cell size - Effective for reading codes with cell spreading
<b>Erosion</b>	For white codes, reduces the cell size - Effective for reading separated dot codes
<b>Median</b>	Removes noise



## Retry function

Code readers must be able to read codes even with poor printing conditions. The FQ2 enables you to retry reading while changing the exposure time and other reading conditions (even for changing workpieces and environments) to achieve stable reading.

**1 - Retrying the specified number of times with the same conditions**

Reading is performed for the specified number of times for the same scene

**2 - Retrying while external trigger is input**

Reading is performed until successful, as long as an external level trigger is input

**3 - Retrying while changing the shutter speed**

Reading is performed for the same scene while changing the exposure time in stages

**4 - retrying while changing the reading conditions**

When reading DPM codes, inconsistencies in printing conditions can result in NGs if reading is performed with only one set of reading settings. The FQ2 allows you to register up to 32 sets of reading conditions as scenes and retry reading while changing the scenes in order. The system automatically determines the scenes with the highest usage rates and changes the order to start with them to flexibly handle changes in reading conditions. Of course you can specify a fixed order if required.

# A versatile line-up

## Sensors that give crystal clear images

A wide choice of sensors are available to match your precise requirements. All-in-one sensors tend to be limited in field of view, but Omron offers a lineup of integrated sensors ranging from 7.5 mm up to 240 mm, which enable a wider variety of applications to be solved.

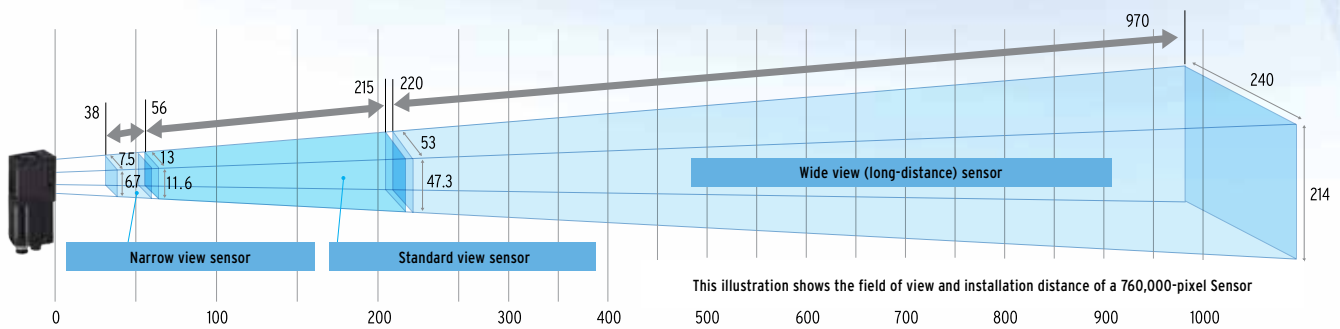

A side-viewing wide-angle camera takes images and performs inspections across a wide area, even if the camera is close to the workpiece. This makes this type of sensor perfect for when you need to mount the camera in locations with limited space. It also enables the sensor to be installed alongside an assembly line without protruding from the side of the conveyor belt.

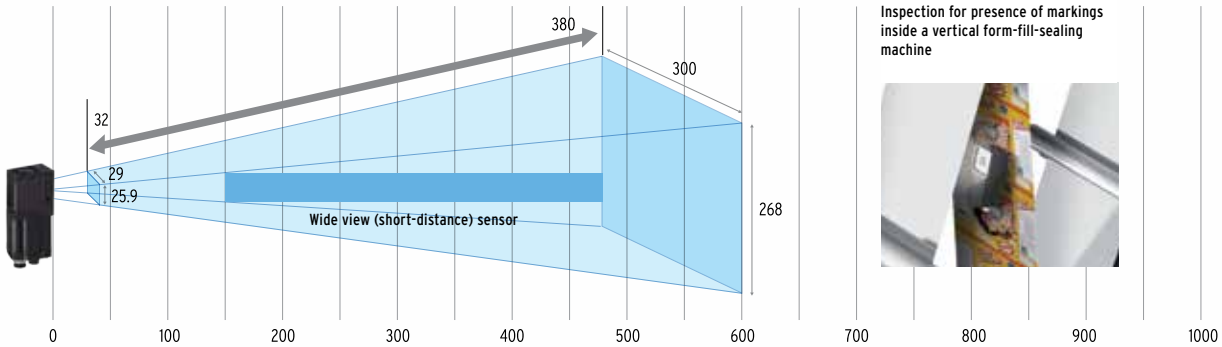

Sensors with C-mount lenses enable freedom of lens selection for longer distances (over 1 metre) and narrow fields of view (under 1 mm), which are not covered by our integrated sensors. This type of sensor is also useful when external illumination is used.

### Long Distance

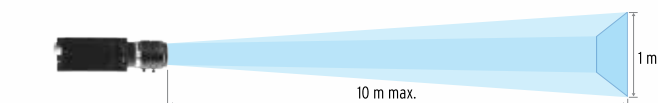

### Narrow Field of View

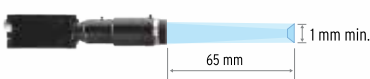

Note: A commercially available telecentric lens is required for narrow field of view applications.

### Lighting Examples



External shape inspections



Defect and foreign matter inspections

# Integrated communication interfaces

The FQ2 sensor includes communication interfaces for compatibility with a wide range of host devices. This helps reduce the design work required for data communications between the sensor and a PLC.



## PLC Link

PLC link greatly reduces the amount of time and work that is required to create ladder programs.

<b>PLC Link compatible models</b>	OMRON PLCs: CS, CJ1, CJ2, CP1 and NSJ Series Mitsubishi Electric: Q Series
-----------------------------------	-------------------------------------------------------------------------------

## FINS

OMRON's exclusive communications interface gives faster, simpler connections to low-cost OMRON PLCs without the need for protocols to process complex TCP packets.

<b>FINS Link compatible models</b>	OMRON PLCs: CS, CJ1, CJ2, CP1 and NSJ Series
------------------------------------	----------------------------------------------

## EtherNet/IP

This widely used communication interface enables simple and easy connections to a wide range of EtherNet/IP devices.

<b>EtherNet/IP compatible models</b>	OMRON Machine Programmable Controllers: NJ Series, OMRON PLCs: CS, CJ1 and CJ2 Series
--------------------------------------	---------------------------------------------------------------------------------------

## I/O Expansion Units

Enable expansion to up to three times the number of I/O connections, allowing the output of individually judged results for each inspection, providing greater flexibility.

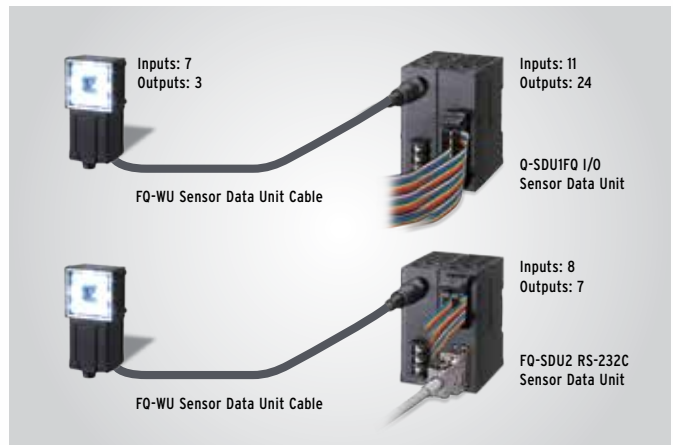

## RS-232C Communications Unit

This sensor data unit supports standard RS-232C communications.

## Time-saving set-up tools

Omron provides two tools for configuration and monitoring of inspection images:

### Touch Finder

A small monitor with a touch panel that can be used onsite to change settings and which can be installed on a control panel.

### PC Setup Tool

Software providing the same functions as Touch Finder, but on a PC. Customers can download the software free of charge.

On-screen messages in nine languages
<ul style="list-style-type: none"> <li>• English</li> <li>• Traditional Chinese</li> <li>• Simplified Chinese</li> <li>• Korean</li> <li>• Japanese</li> <li>• German</li> <li>• French</li> <li>• Italian</li> <li>• Spanish</li> </ul>

# Further useful onsite utilities

## Real-time threshold adjustment

The FQ2 smart camera allows fast and easy real-time parameter adjustment that eliminates the need to stop the machine for fine tuning and optimisation of settings, resulting in zero machine downtime.



## Inspection history logging

Samples are fed down the line and inspection results are logged. The logged data can be checked on a time scale in graph form and used to adjust judgement conditions. This is very useful for testing a new line during operation. Large inspection histories can be saved on SD cards and used later for traceability.

**Recent results logging**

Displays the most recent 1,000 inspection results in graph form

**File logging**

SD card

Up to 10 million measurement values or more (for a 4-GB SD card)  
Up to 10,000 images or more (for a 4-GB SD card)

## Auto Detection

When multiple sensors are connected to the touch finder, the display automatically switches to the image of the sensor that has produced an NG result. This allows dynamic visualisation of reject conditions.

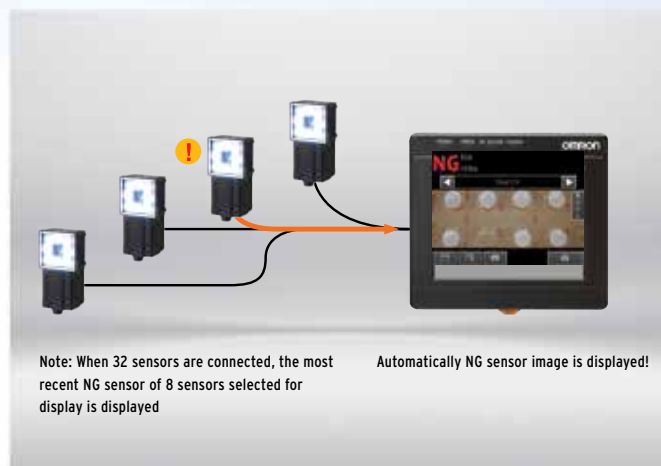



### 180° inverted-image display

Images can be inverted by 180° to aid visualisation when the camera can only be mounted in the wrong orientation to the product.



### Password protection

A password can be set to prevent changes to settings during operation by restricting the ability to change from Run mode to Setup mode.







### Shortcuts

Shortcuts to the Setup menu items that are changed frequently can be added to the Run Mode display. This enables the user to quickly perform adjustments when a problem occurs during operation.



Lineup ranging from single-function models to full-function models

Inspection model

		FQ-S1 series Single-function type	FQ-S2 series Standard type	FQ-S3 series High-resolution type	
		Integrated sensor	Integrated sensor	Integrated sensor	C-mount
					
Number of pixels		350,000 pixels	350,000 pixels	760,000 pixels	1.3 million pixels
Color		Real color	Real color	Real color/Monochrome	Real color/Monochrome
Number of simultaneous measurements		1	32	32	32
Number of registered scenes		8	32	32	32
Inspection	Shape search II	■	■	■	■
	Search	■	■	■	■
	Sensitive search	■	■	■	■
	Edge position	■	■	■	■
	Edge width	■	■	■	■
	Edge pitch	■	■	■	■
	Area	■	■	■	■
	Color data	■	■	■	■
ID	Labeling	■	■	■	■
	Bar code	-	-	-	-
	2D code	-	-	-	-
	2D code (DPM) <sup>*1</sup>	-	-	-	-
I/O specifications	OCR	-	-	-	-
	Communications (Ethernet TCP no-protocol, Ethernet UDP no-protocol, Ethernet FINS/TCP no-protocol, EtherNet/IP, PLC Link, or PROFINET)	■	■	■	■
	Sensor Data Units (I/O)	-	-	■	■
	Sensor Data Units (RS-232C)	-	-	■	■

\*1 Inspection item for directly marked 2D codes.

Inspection/ID model



		FQ2-S4 Series		
		Integrated Sensor	Integrated Sensor	C-mount
				
Number of pixels		350,000 pixels	760,000 pixels	1.3 million pixels
Color		Real color/Monochrome	Real color/Monochrome	Real color/Monochrome
Number of simultaneous measurements		32	32	32
Number of registered scenes		32	32	32
Inspection	Shape search II	■	■	■
	Search	■	■	■
	Sensitive search	■	■	■
	Edge position	■	■	■
	Edge width	■	■	■
	Edge pitch	■	■	■
	Area	■	■	■
	Color data	■	■	■
ID	Labeling	■	■	■
	Bar code	■	■	■
	2D code	■	■	■
	2D code (DPM) <sup>*1</sup>	■	■	■
I/O specifications	OCR	■	■	■
	Communications (Ethernet TCP no-protocol, Ethernet UDP no-protocol, Ethernet FINS/TCP no-protocol, EtherNet/IP, PLC Link, or PROFINET)	■	■	■
	Sensor Data Units (I/O)	■	■	■
	Sensor Data Units (RS-232C)	■	■	■

\*1 Inspection item for directly marked 2D codes.

# FQ2

# Inspection systems

## ID model

		FQ2-CH Series Optical Character Recognition Sensor	FQ-CR1 Series Multi Code Reader	FQ-CR2 Series 2D Code Reader
		Integrated Sensor	Integrated Sensor	Integrated Sensor
				
<b>Number of pixels</b>		350,000 pixels	350,000 pixels	350,000 pixels
<b>Color</b>		Monochrome	Monochrome	Monochrome
<b>Number of simultaneous measurements</b>		32	32	32
<b>Number of registered scenes</b>		32	32	32
<b>Inspection</b>	<b>Shape search II</b>	–	–	–
	<b>Search</b>	–	–	–
	<b>Sensitive search</b>	–	–	–
	<b>Edge position</b>	–	–	–
	<b>Edge width</b>	–	–	–
	<b>Edge pitch</b>	–	–	–
	<b>Area</b>	–	–	–
	<b>Color data</b>	–	–	–
	<b>Labeling</b>	–	–	–
	<b>ID</b>	<b>Bar code</b>	–	■
<b>2D code</b>		–	■	–
<b>2D code (DPM)<sup>*1</sup></b>		–	–	■
<b>OCR</b>		■	–	–
<b>I/O specifications</b>	<b>Communications (Ethernet TCP no-protocol, Ethernet FINS/TCP no-protocol, EtherNet/IP, or PLC Link)</b>	■	–	–
	<b>Sensor Data Units (I/O)</b>	■	–	–
	<b>Sensor Data Units (RS-232C)</b>	■	–	–

\*1 Inspection item for directly marked 2D codes.

## Ordering Information

### Sensor

#### Inspection model

##### FQ2-S1 Series [Single-function Type]

Field of vision	Narrow View	Standard View	Wide View (Long-distance)	Wide View (Short-distance)
Number of pixels	350,000 pixels			
Color	NPN	FQ2-S10010F	FQ2-S10050F	FQ2-S10100F
	PNP	FQ2-S15010F	FQ2-S15050F	FQ2-S15100F
Field of vision/Installation distance	Refer to figure 1 on page 18.	Refer to figure 2 on page 18.	Refer to figure 3 on page 18.	Refer to figure 4 on page 18.

##### FQ2-S2 Series [Standard Type]

Field of vision	Narrow View	Standard View	Wide View (Long-distance)	Wide View (Short-distance)
Number of pixels	350,000 pixels			
Color	NPN	FQ2-S20010F	FQ2-S20050F	FQ2-S20100F
	PNP	FQ2-S25010F	FQ2-S25050F	FQ2-S25100F
Field of vision/Installation distance	Refer to figure 1 on page 18.	Refer to figure 2 on page 18.	Refer to figure 3 on page 18.	Refer to figure 4 on page 18.

##### FQ2-S3 Series [High-resolution Type]

Field of vision	Narrow View	Standard View	Wide View (Long-distance)	Wide View (Short-distance)	C-mount
Number of pixels	760,000 pixels				1.3 million pixels
Color	NPN	FQ2-S30010F-08	FQ2-S30050F-08	FQ2-S30100F-08	FQ2-S30100N-08
	PNP	FQ2-S35010F-08	FQ2-S35050F-08	FQ2-S35100F-08	FQ2-S35100N-08
Monochrome	NPN	FQ2-S30010F-08M	FQ2-S30050F-08M	FQ2-S30100F-08M	FQ2-S30100N-08M
	PNP	FQ2-S35010F-08M	FQ2-S35050F-08M	FQ2-S35100F-08M	FQ2-S35100N-08M
Field of vision/Installation distance	Refer to figure 5 on page 18.	Refer to figure 6 on page 18.	Refer to figure 7 on page 18.	Refer to figure 8 on page 18.	Refer to optical chart on p. 27

#### Inspection / ID model

##### FQ2-S4 Series [Standard Type]

Field of vision	Narrow View	Standard View	Wide View (Long-distance)	Wide View (Short-distance)
Number of pixels	350,000 pixels			
Color	NPN	FQ2-S40010F	FQ2-S40050F	FQ2-S40100F
	PNP	FQ2-S45010F	FQ2-S45050F	FQ2-S45100F
Monochrome	NPN	FQ2-S40010F-M	FQ2-S40050F-M	FQ2-S40100F-M
	PNP	FQ2-S45010F-M	FQ2-S45050F-M	FQ2-S45100F-M
Field of vision/Installation distance	Refer to figure 1 on page 18.	Refer to figure 2 on page 18.	Refer to figure 3 on page 18.	Refer to figure 4 on page 18.

# FQ2

# Inspection systems

[High-resolution Type]

Field of vision		Narrow View	Standard View	Wide View (Long-distance)	Wide View (Short-distance)	C-mount
Number of pixels		760,000 pixels				1.3 million pixels
Color	NPN	FQ2-S40010F-08	FQ2-S40050F-08	FQ2-S40100F-08	FQ2-S40100N-08	FQ2-S40-13
	PNP	FQ2-S45010F-08	FQ2-S45050F-08	FQ2-S45100F-08	FQ2-S45100N-08	FQ2-S45-13
Monochrome	NPN	FQ2-S40010F-08M	FQ2-S40050F-08M	FQ2-S40100F-08M	FQ2-S40100N-08M	FQ2-S40-13M
	PNP	FQ2-S45010F-08M	FQ2-S45050F-08M	FQ2-S45100F-08M	FQ2-S45100N-08M	FQ2-S45-13M
Field of vision/Installation distance		Refer to figure 5 on page 18.	Refer to figure 6 on page 18.	Refer to figure 7 on page 18.	Refer to figure 8 on page 18.	Refer to optical chart on p. 27

**ID Model**

**FQ2-CH Series [Optical Character Recognition Sensor]**

Field of vision		Narrow View	Standard View	Wide View (Long-distance)	Wide View (Short-distance)
Number of pixels		350,000 pixels			
Monochrome	NPN	FQ2-CH10010F-M	FQ2-CH10050F-M	FQ2-CH10100F-M	FQ2-CH10100N-M
	PNP	FQ2-CH15010F-M	FQ2-CH15050F-M	FQ2-CH15100F-M	FQ2-CH15100N-M
Field of vision/Installation distance		Refer to figure 1 on page 18.	Refer to figure 2 on page 18.	Refer to figure 3 on page 18.	Refer to figure 4 on page 18.

**FQ-CR1 Series [Multi Code Reader]**

Field of vision		Narrow View	Standard View	Wide View (Long-distance)	Wide View (Short-distance)
Number of pixels		350,000 pixels			
Monochrome	NPN	FQ-CR10010F-M	FQ-CR10050F-M	FQ-CR10100F-M	FQ-CR10100N-M
	PNP	FQ-CR15010F-M	FQ-CR15050F-M	FQ-CR15100F-M	FQ-CR15100N-M
Field of vision/Installation distance		Refer to figure 1 on page 18.	Refer to figure 2 on page 18.	Refer to figure 3 on page 18.	Refer to figure 4 on page 18.

**FQ-CR2 Series [2D Code Reader]**

Field of vision		Narrow View	Standard View	Wide View (Long-distance)	Wide View (Short-distance)
Number of pixels		350,000 pixels			
Monochrome	NPN	FQ-CR20010F-M	FQ-CR20050F-M	FQ-CR20100F-M	FQ-CR20100N-M
	PNP	FQ-CR25010F-M	FQ-CR25050F-M	FQ-CR25100F-M	FQ-CR25100N-M
Field of vision/Installation distance		Refer to figure 1 on page 18.	Refer to figure 2 on page 18.	Refer to figure 3 on page 18.	Refer to figure 4 on page 18.

**Field of vision/Installation distance**

(Unit: mm)

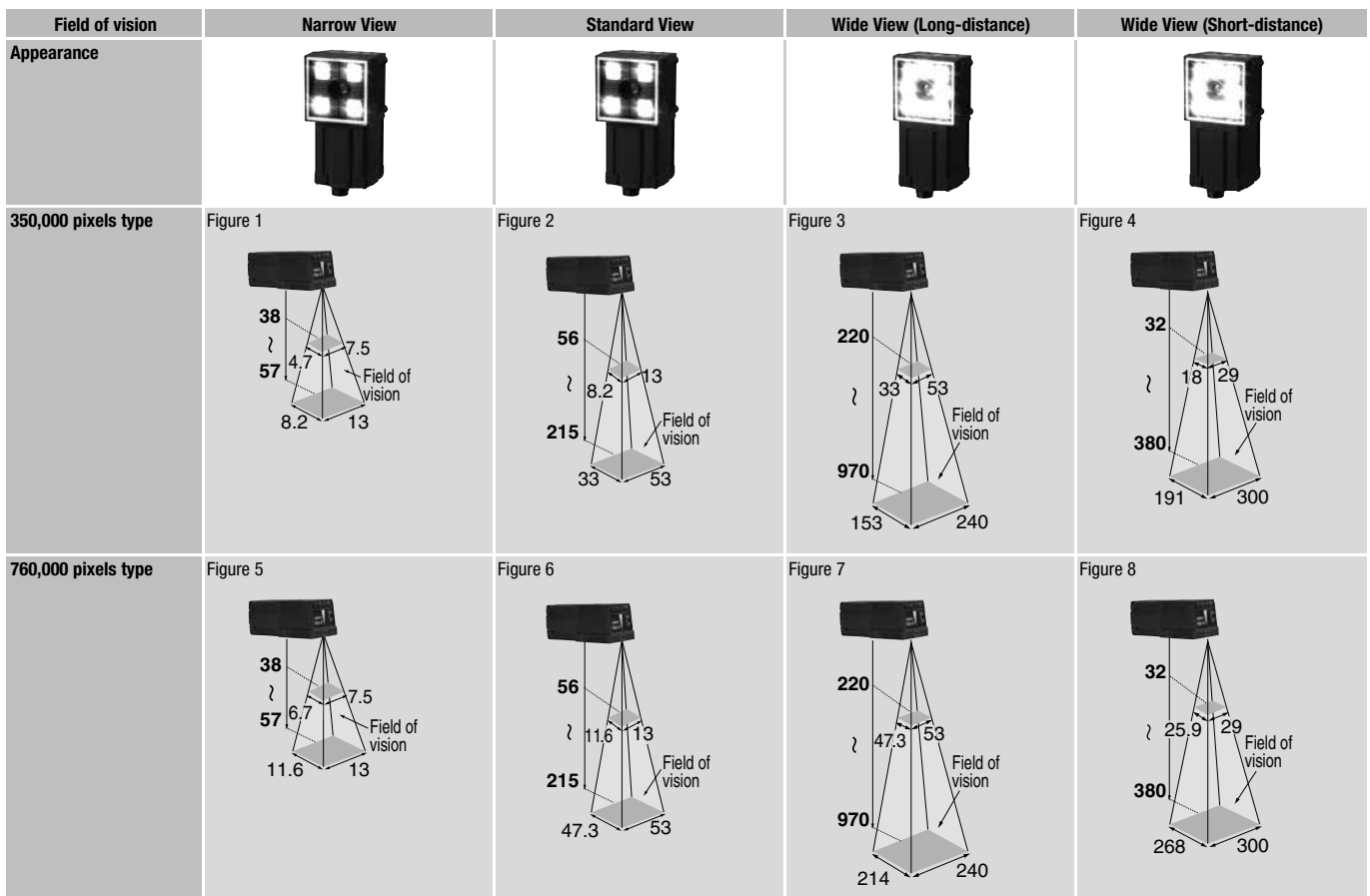



# FQ2

# Inspection systems



## Touch Finder

Type	Appearance	Model
DC power supply		FQ2-D30
AC/DC/battery		FQ2-D31



## Cables

Type	Appearance	Cable length	Model
FQ Ethernet Cables (connect Sensor to Touch Finder, Sensor to PC)		2m	FQ-WN002
		5m	FQ-WN005
		10m	FQ-WN010
		20m	FQ-WN020
I/O Cables		2m	FQ-WD002
		5m	FQ-WD005
		10m	FQ-WD010
		20m	FQ-WD020

## Sensor Data Unit (FQ2-S3/S4/CH only)

Type	Appearance	Output type	Model
Parallel Interface		NPN	FQ-SDU10
		PNP	FQ-SDU15
RS-232C Interface		NPN	FQ-SDU20
		PNP	FQ-SDU25

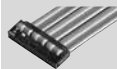
## Cables for Sensor Data Unit

Type	Appearance	Cable length	Model
Sensor Data Unit Cable		2m	FQ-WU002
		5m	FQ-WU005
		10m	FQ-WU010
		20m	FQ-WU020
Parallel Cable for FQ-SDU1 <sup>*1</sup>		2m	FQ-VP1002
		5m	FQ-VP1005
		10m	FQ-VP1010
Parallel Cable for FQ-SDU2 <sup>*1</sup>		2m	FQ-VP2002
		5m	FQ-VP2005
		10m	FQ-VP2010
RS-232C Cable for FQ-SDU2 <sup>*1</sup>		2m	XW2Z-200S-V
		5m	XW2Z-500S-V

<sup>\*1</sup> When using FQ-SDU□□, 2 cables are required for all I/O signals.

## External Lighting

Type	Model
3Z4S-LT Series	Refer to 3Z4S-LT/LE Series Catalog (Q164)
FL Series	Refer to FL Series Catalog (Q181)

## Lenses for C-mount Camera. Refer to optical chart on p. 27 for selection of a lens.

### High-resolution, Low-distortion Lenses

Model	3Z4S-LE SV-0614H	3Z4S-LE SV-0814H	3Z4S-LE SV-1214H	3Z4S-LE SV-1614H	3Z4S-LE SV-2514H	3Z4S-LE SV-3514H	3Z4S-LE SV-5014H	3Z4S-LE SV-7525H	3Z4S-LE SV-10028H
Appearance									
Focal length	6 mm	8 mm	12 mm	16 mm	25 mm	35 mm	50 mm	75 mm	100 mm
Brightness	F1.4	F1.4	F1.4	F1.4	F1.4	F1.4	F1.4	F2.5	F2.8
Filter size	M40.5 P0.5	M35.5 P0.5	M27 P0.5	M27 P0.5	M27 P0.5	M35.5 P0.5	M40.5 P0.5	M34.0 P0.5	M37.5 P0.5

## Extension Tubes

Model	3Z4S-LE SV-EXR
Contents	Set of 7 tubes (40 mm, 20 mm, 10 mm, 5 mm, 2.0 mm, 1.0 mm, and 0.5 mm) Maximum outer diameter: 30 mm dia.

## Accessories

Application	Appearance	Name	Model
For Sensor		Mounting Bracket <sup>*1</sup>	FQ-XL
		Mounting Bracket	FQ-XL2
		Mounting Base for C-mount type <sup>*2</sup>	FQ-XLC
		Polarizing Filter Attachment <sup>*1</sup>	FQ-XF1
For Touch Finder		Panel Mounting Adapter	FQ-XPM
		AC Adapter (for AC/DC/battery model) <sup>*3</sup>	FQ-A□
		Battery (for AC/DC/battery model)	FQ-BAT1
		Touch Pen <sup>*4</sup>	FQ-XT
		Strap	FQ-XH
		SD Card (2 GB)	HMC-SD291

<sup>\*1</sup> Included with Integrated Sensor.



<sup>\*2</sup> Included with Sensor with C-mount.

<sup>\*3</sup> AC Adapters for Touch Finder with DC/AC/Battery Power Supply. Select the model for the country in which the Touch Finder will be used.

Plug Type	Voltage	Certified standards	Model
A	125 V max.	PSE	FQ-AC1
		UL/CSA	FQ-AC2
	250 V max.	CCC mark	FQ-AC3
C	250 V max.	–	FQ-AC4
BF	250 V max.	–	FQ-AC5
C	250 V max.	–	FQ-AC6

<sup>\*4</sup> Enclosed with Touch Finder.

## Industrial Switching Hubs (Recommended)

Appearance	Number of ports	Failure detection	Current consumption	Model
	3	None	0.22 A	W4S1-03B
	5	None	0.22 A	W4S1-05B
		Supported		W4S1-05C

Note: Do not use the 0.5-mm, 1.0-mm, and 2.0-mm Extension Tubes attached to each other. Since these Extension Tubes are placed over the threaded section of the Lens or other Extension Tube, the connection may loosen when more than one 0.5-mm, 1.0-mm or 2.0-mm Extension Tube are used together.

Note: Reinforcement is required to protect against vibration when Extension Tubes exceeding 30 mm are used.

## System Configuration

Up to 32 Sensors can be set up and monitored from a single Touch Finder or PC Tool.

Various types of Sensors can be used at the same time.

However, I/O type and wiring method vary depending on the Sensor, so select the necessary devices.

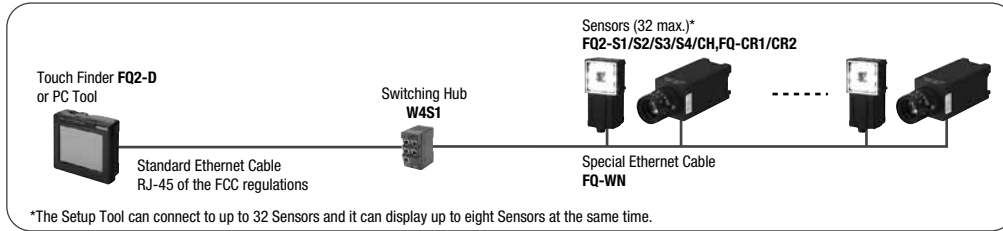

\*The Setup Tool can connect to up to 32 Sensors and it can display up to eight Sensors at the same time.

**Note:** Note: If you register as a member after purchasing a Sensor, you can download free setup software that runs on a PC and can be used in place of Touch Finder. Refer to the member registration sheet for details.

### Ethernet (EtherNet/IP, No-protocol, or PLC Link) Connection

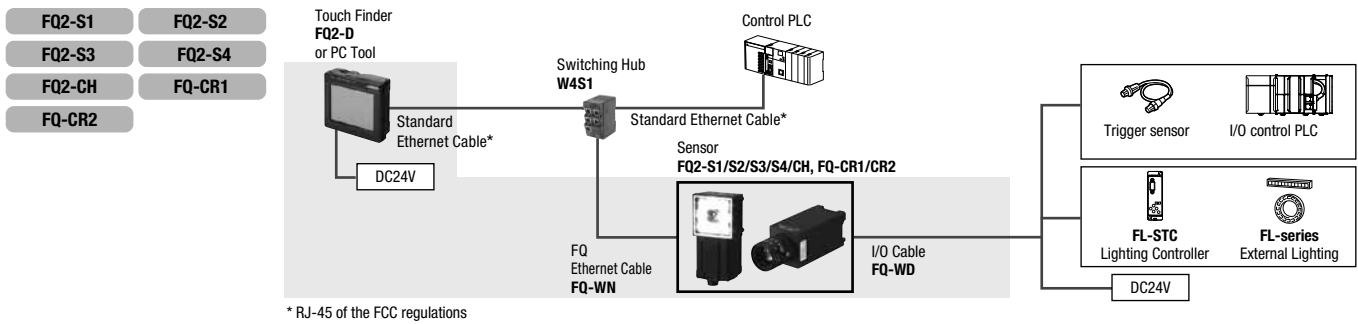

\* RJ-45 of the FCC regulations

### Parallel Interface Connection

Connection with Standard Parallel Interface of the Sensor

- FQ2-S1
- FQ2-S2
- FQ2-S3
- FQ2-S4
- FQ2-CH
- FQ-CR1
- FQ-CR2

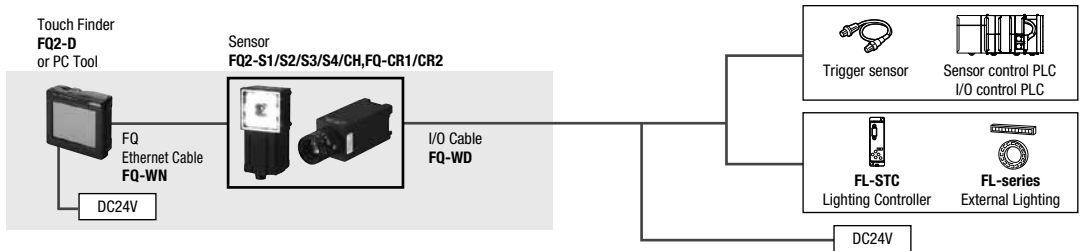

Connection through a Parallel Interface Sensor Data Unit

- FQ2-S1
- FQ2-S2
- FQ2-S3
- FQ2-S4
- FQ2-CH
- FQ-CR1
- FQ-CR2

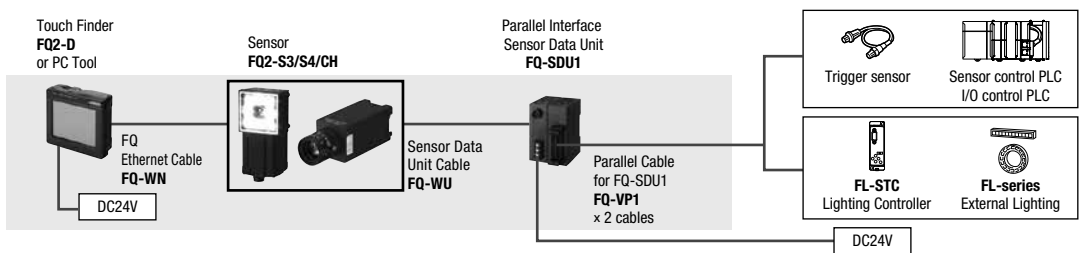

### RS-232C Serial Connection

- FQ2-S1
- FQ2-S2
- FQ2-S3
- FQ2-S4
- FQ2-CH
- FQ-CR1
- FQ-CR2

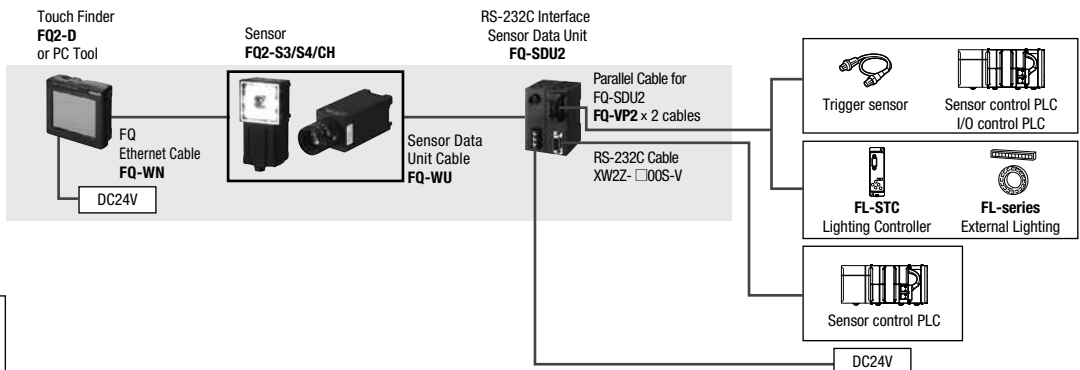

Model compatible with communications interface

- Compatible
- Not compatible

## Ratings and Performance

## Sensor

## Inspection Model FQ2-S1/S2/S3 Series

Item		Single-function type	Standard type	High-resolution type			
Model	NPN	FQ2-S10□□□□	FQ2-S20□□□□	FQ2-S30□□□□-08	FQ2-S30□□□□-08M	FQ2-S30-13	FQ2-S30-13M
	PNP	FQ2-S15□□□□	FQ2-S25□□□□	FQ2-S35□□□□-08	FQ2-S35□□□□-08M	FQ2-S35-13	FQ2-S35-13M
Field of view		Refer to Ordering Information on p.19. (Tolerance (field of vision): ±10% max.)				Select a lens according to the field of vision and installation distance. Refer to optical chart on p. 27.	
Installation distance							
Main functions	Inspection items	Search, shape search II, sensitive search, area, color data, edge position, edge pitch, edge width, and labeling					
	Number of simultaneous measurements	1	32				
	Position compensation	Supported (360° Model position compensation, Edge position compensation)					
	Number of registered scenes	8	32				
	Calibration	Supported					
Image input	Image processing method	Real color			Monochrome	Real color	Monochrome
	Image filter	High dynamic range (HDR), image adjustment (Color Gray Filter, Weak smoothing, Strong smoothing, Dilate, Erosion, Median, Extract edges, Extract horizontal edges, Extract vertical edges, Enhance edges, Background suppression), polarizing filter (attachment), and white balance (Sensors with Color Cameras only)					
	Image elements	1/3-inch color CMOS		1/2-inch color CMOS	1/2-inch Monochrome CMOS	1/2-inch color CMOS	1/2-inch Monochrome CMOS
	Shutter	Built-in lighting ON: 1/250 to 1/50,000 Built-in lighting OFF: 1/1 to 1/50,000		Built-in lighting ON: 1/250 to 1/60,000 Built-in lighting OFF: 1/1 to 1/60,000		1/1 to 1/60,000	
	Processing resolution	752 × 480		928 × 828		1280 × 1024	
	Partial input function	Supported horizontally only.		Supported horizontally and vertically			
	Lens mounts	-					C-mount
Lighting	Lighting method	Pulse				-	
	Lighting color	White				-	
Data logging	Measurement data	In Sensor: 1,000 items (If a Touch Finder is used, results can be saved up to the capacity of an SD card.)					
	Images	In Sensor: 20 images (If a Touch Finder is used, images can be saved up to the capacity of an SD card.)					
Auxiliary function		Math (arithmetic, calculation functions, trigonometric functions, and logic functions)					
Measurement trigger		External trigger (single or continuous) Communications trigger (Ethernet TCP no-protocol, Ethernet UDP no-protocol, Ethernet FINS/TCP no-protocol, EtherNet/IP, PLC Link, or PROFINET)					
I/O specifications	Input signals	7 signals Single measurement input (TRIG) Control command input (IN0 to IN5)					
	Output signals	3 signals Control output (BUSY) Overall judgement output (OR) Error output (ERROR) The assignments of the three output signals (OUT0 to OUT2) can be changed to the individual judgements of the inspection items, the image input ready output (READY), or the external lighting timing output (STGOUT).					
	Ethernet specifications	100Base-TX/10Base-T					
	Communications	Ethernet TCP no-protocol, Ethernet UDP no-protocol, Ethernet FINS/TCP no-protocol, EtherNet/IP, PLC Link, or PROFINET					
	I/O expansion	-	-	Possible by connecting FQ-SDU1_ Sensor Data Unit. 11 inputs and 24 outputs			
	RS-232C	-	-	Possible by connecting FQ-SDU2_ Sensor Data Unit. 8 inputs and 7 outputs			
	Ratings	Power supply voltage	21.6 to 26.4 VDC (including ripple)				
Current consumption		2.4 A max.				0.3 A max.	
Environmental immunity	Ambient temperature range	Operating: 0 to 50°C Storage: -25 to 65°C (with no icing or condensation)		Operating: 0 to 40°C Storage: -25 to 65°C (with no icing or condensation)			
	Ambient humidity range	Operating and storage: 35% to 85% (with no condensation)					
	Ambient atmosphere	No corrosive gas					
	Vibration resistance (destruction)	10 to 150 Hz, single amplitude: 0.35 mm, X/Y/Z directions 8 min each, 10 times					
	Shock resistance (destruction)	150 m/s <sup>2</sup> 3 times each in 6 direction (up, down, right, left, forward, and backward)					
	Degree of protection	IEC 60529 IP67 (Except when Polarizing Filter Attachment is mounted or connector cap is removed.)				IEC 60529 IP40	
Materials	Sensor: PBT, PC, SUS Mounting Bracket: PBT Polarizing Filter Attachment: PBT, PC Ethernet connector: Oil-resistance vinyl compound I/O connector: Lead-free heat-resistant PVC				Cover: Zinc-plated steel, Thickness: 0.6 mm Case: Aluminum diecast alloy (ADC-12) Mounting base: Polycarbonate ABS		
Weight	Narrow View/Standard View: Approx. 160 g Wide View: Approx. 150 g				Approx. 160 g without base, Approx. 185 g with base		
Accessories included with sensor	Mounting Bracket (FQ-XL) (1) Polarizing Filter Attachment (FQ-XF1) (1) Instruction Manual, Quick Startup Guide Member Registration Sheet, Warning Label				Mounting Base (FQ-XLC) (1) Mounting Screw (M3 × 8mm) (4) Instruction Manual, Quick Startup Guide Member Registration Sheet		

Item		Single-function type	Standard type	High-resolution type				
Model	NPN	FQ2-S10□□□□	FQ2-S20□□□□	FQ2-S30□□□□-08	FQ2-S30□□□□-08M	FQ2-S30-13	FQ2-S30-13M	
	PNP	FQ2-S15□□□□	FQ2-S25□□□□	FQ2-S35□□□□-08	FQ2-S35□□□□-08M	FQ2-S35-13	FQ2-S35-13M	
LED class		Class 2(Applicable standards: IEC 60825-1:1993 +A1:1997 +A2:2001, EN 60825-1:1994 +A1:2002 +A2:2001, and JIS C 6802:2005)					-	
Applicable standards		EN standard EN 61326 and EC Directive No.2004/104/EC			EN 61326-1:2006 and IEC 61010-1			

## Inspection/ID Model FQ2-S4 Series

Item	Inspection/ID Model							
Model	NPN	FQ2-S40□□□□	FQ2-S40□□□□-M	FQ2-S40□□□□-08	FQ2-S40□□□□-08M	FQ2-S40□□□□-13	FQ2-S40□□□□-13M	
	PNP	FQ2-S45□□□□	FQ2-S45□□□□-M	FQ2-S45□□□□-08	FQ2-S45□□□□-08M	FQ2-S45□□□□-13	FQ2-S45□□□□-13M	
Field of view	Refer to Ordering Information on p.19. (Tolerance (field of vision): ±10% max.)					Select a lens according to the field of vision and installation distance. Refer to optical chart on p. 27.		
Installation distance								
Main functions	Inspection items	Search, shape search II, sensitive search, area, color data, edge position, edge pitch, edge width, labeling, OCR <sup>1</sup> , Bar code <sup>2</sup> , 2D-code <sup>2</sup> , 2D-code (DMP) <sup>3</sup> , and Model dictionary						
	Number of simultaneous measurements	32						
	Position compensation	Supported (360° Model position compensation, Edge position compensation)						
	Number of registered scenes	32						
	Calibration	Supported						
	Retry function	Normal retry, Exposure retry, Scene retry, Trigger retry						
Image input	Image processing method	Real color	Monochrome	Real color	Monochrome	Real color	Monochrome	
	Image filter	High dynamic range (HDR), image adjustment (Color Gray Filter, Weak smoothing, Strong smoothing, Dilate, Erosion, Median, Extract edges, Extract horizontal edges, Extract vertical edges, Enhance edges, Background suppression), polarizing filter (attachment), and white balance (Sensors with Color Cameras only)						
	Image elements	1/3-inch color CMOS	1/3-inch Monochrome CMOS	1/2-inch color CMOS	1/2-inch Monochrome CMOS	1/2-inch color CMOS	1/2-inch Monochrome CMOS	
	Shutter	Built-in lighting ON: 1/250 to 1/50,000 Built-in lighting OFF: 1/1 to 1/50,000		Built-in lighting ON: 1/250 to 1/60,000 Built-in lighting OFF: 1/1 to 1/60,000		1/1 to 1/60,000		
	Processing resolution	752 × 480		928 × 828		1280 × 1024		
	Partial input function	Supported horizontally only.		Supported horizontally and vertically				
	Lens mounts	-					C-mount	
Lighting	Lighting method	Pulse					-	
	Lighting color	White					-	
Data logging	Measurement data	In Sensor: 1,000 items (If a Touch Finder is used, results can be saved up to the capacity of an SD card.)						
	Images	In Sensor: 20 images (If a Touch Finder is used, images can be saved up to the capacity of an SD card.)						
Auxiliary function	Math (arithmetic, calculation functions, trigonometric functions, and logic functions)							
Measurement trigger	External trigger (single or continuous) Communications trigger (Ethernet TCP no-protocol, Ethernet UDP no-protocol, Ethernet FINS/TCP no-protocol, EtherNet/IP, PLC Link, or PROFINET)							
I/O specifications	Input signals	7 signals Single measurement input (TRIG) Control command input (INO to IN5)						
	Output signals	3 signals Control output (BUSY) Overall judgement output (OR) Error output (ERROR) The assignments of the three output signals (OUT0 to OUT2) can be changed to the individual judgements of the inspection items, the image input ready output (READY), or the external lighting timing output (STGOUT).						
	Ethernet specifications	100Base-TX/10Base-T						
	Communications	Ethernet TCP no-protocol, Ethernet UDP no-protocol, Ethernet FINS/TCP no-protocol, EtherNet/IP, PLC Link, or PROFINET						
	I/O expansion	Possible by connecting FQ-SDU1_ Sensor Data Unit. 11 inputs and 24 outputs						
	RS-232C	Possible by connecting FQ-SDU2_ Sensor Data Unit. 8 inputs and 7 outputs						
Ratings	Power supply voltage	21.6 to 26.4 VDC (including ripple)					0.3 A max.	
	Current consumption	2.4 A max.					0.3 A max.	
Environmental immunity	Ambient temperature range	Operating: 0 to 40°C Storage: -25 to 65°C (with no icing or condensation)						
	Ambient humidity range	Operating and storage: 35% to 85% (with no condensation)						
	Ambient atmosphere	No corrosive gas						
	Vibration resistance (destruction)	10 to 150 Hz, single amplitude: 0.35 mm, X/Y/Z directions 8 min each, 10 times						
	Shock resistance (destruction)	150 m/s <sup>2</sup> 3 times each in 6 direction (up, down, right, left, forward, and backward)						
	Degree of protection	IEC 60529 IP67 (Except when Polarizing Filter Attachment is mounted or connector cap is removed.)					IEC 60529 IP40	
Materials	Sensor: PBT, PC, SUS Mounting Bracket: PBT Polarizing Filter Attachment: PBT, PC Ethernet connector: Oil-resistance vinyl compound I/O connector: Lead-free heat-resistant PVC					Cover: Zinc-plated steel, Thickness: 0.6 mm Case: Aluminum diecast alloy (ADC-12) Mounting base: Polycarbonate ABS		

## FQ2

## Inspection systems

Item		Inspection/ID Model					
Model	NPN	FQ2-S40□□□□	FQ2-S40□□□□-M	FQ2-S40□□□□-08	FQ2-S40□□□□-08M	FQ2-S40□□□□-13	FQ2-S40□□□□-13M
	PNP	FQ2-S45□□□□	FQ2-S45□□□□-M	FQ2-S45□□□□-08	FQ2-S45□□□□-08M	FQ2-S45□□□□-13	FQ2-S45□□□□-13M
Weight		Narrow View/Standard View:Approx.160 g Wide View:Approx.150 g				Approx. 160 g without base, Approx. 185 g with base	
Accessories included with sensor		Mounting Bracket (FQ-XL)(1) Polarizing Filter Attachment (FQ-XF1) (1) Instruction Manual, Quick Startup Guide Member Registration Sheet, Warning Label				Mounting Base (FQ-XLC) (1) Mounting Screw (M3 × 8mm)(4) Instruction Manual, Quick Startup Guide Member Registration Sheet	
LED class		Class 2(Applicable standards: IEC 60825-1:1993 +A1:1997 +A2:2001, EN 60825-1:1994 +A1:2002 +A2:2001, and JIS C 6802:2005)				—	
Applicable standards		EN 61326-1:2006 and IEC 61010-1					

\*1 The types of characters to be read are the same as those of FQ2-CH Optical Character Recognition Sensor.

\*2 The types of codes to be read are the same as those of FQ-CR1 Multi Code Reader.

\*3 The types of codes to be read are the same as those of FQ-CR2 2D Code Reader.

## ID Model FQ2-CH, FQ-CR1/CR2 Series

Item		Optical Character Recognition Sensor	Multi Code Reader	2D Code Reader
Model	NPN	FQ2-CH10□□□□-M	FQ-CR10□□□□-M	FQ-CR20□□□□-M
	PNP	FQ2-CH15□□□□-M	FQ-CR15□□□□-M	FQ-CR25□□□□-M
Field of view		Refer to ordering information on page 17. (Tolerance (field of vision): ±10% max.)		
Installation distance				
Main functions	Inspection items	OCR · Alphabet A to Z · Number 0 to 9 · Symbol ' - . : / Model dictionary	2D Code (Data Matrix(EC200), QR Code, MicroQR Code, PDF417, MicroPDF417, GS1-Data Matrix) Bar Code (JAN/EAN/UPC, Code39, Codabar (NW-7), ITF (Interleaved 2 of 5), Code 93, Code128/ GS1-128, GS1 DataBar* (Truncated, Stacked, Omnidirectional, Stacked Omnidirectional, Limited, Expanded, Expanded Stacked), Pharmacode, GS1-128 Composite Code (CC-A, CC-B, CC-C)	2D Code (Data Matrix(EC200), QR Code)
	Image filter	Weak smoothing, Strong smoothing, Dilate, Erosion, Median, Extract edges, Extract horizontal edges, Extract vertical edges, Enhance edges, Background suppression	None	Filter function (Smooth, Dilate, Erosion, Median), Code Error Correction Position Display
	Verification function	Supported	Supported	None
	Retry function	Normal retry, Exposure retry, Scene retry, Trigger retry		
	Number of simultaneous measurements	32		
	Position compensation	Supported (360° Model position compensation, Edge position compensation)	None	
	Number of registered scenes	32		
Image input	Image processing method	Monochrome		
	Image filter	High dynamic range (HDR) and polarizing filter (attachment)		
	Image elements	1/3-inch Monochrome CMOS		
	Shutter	Built-in lighting ON: 1/250 to 1/50,000 Built-in lighting OFF: 1/1 to 1/50,000	1/250 to 1/30,000	1/250 to 1/32,258
	Processing resolution	752 × 480		
	Partial input function	Supported horizontally only.		
Lighting	Lighting method	Pulse		
	Lighting color	White		
Data logging	Measurement data	In Sensor: 1,000 items (If a Touch Finder is used, results can be saved up to the capacity of an SD card.)		
	Images	In Sensor: 20 images (If a Touch Finder is used, images can be saved up to the capacity of an SD card.)		
Auxiliary function		Math (arithmetic, calculation functions, trigonometric functions, and logic functions)		
Measurement trigger		External trigger (single or continuous) Communications trigger (Ethernet TCP no-protocol, Ethernet UDP no-protocol, Ethernet FINS/TCP no-protocol, EtherNet/IP, PLC Link, or PROFINET)	External trigger (single or continuous)	

## FQ2

## Inspection systems

Item	Optical Character Recognition Sensor		Multi Code Reader	2D Code Reader
Model	NPN	FQ2-CH10□□□□-M	FQ-CR10□□□□-M	FQ-CR20□□□□-M
	PNP	FQ2-CH15□□□□-M	FQ-CR15□□□□-M	FQ-CR25□□□□-M
I/O specifications	Input signals	7 signals Single measurement input (TRIG) Control command input (INO to IN5)		
	Output signals	3 signals Control output (BUSY) Overall judgement output (OR) Error output (ERROR) The assignments of the three output signals (OUT0 to OUT2) can be changed to the individual judgements of the inspection items, the image input ready output (READY), or the external lighting timing output (STGOUT).	3 signals Control output (BUSY) Overall judgement output (OR) Error output (ERROR) Note: The three output signals can be allocated for the judgements of individual inspection items.	
	Ethernet specifications	100Base-TX/10Base-T		
	Communications	Ethernet TCP no-protocol, Ethernet UDP no-protocol, Ethernet FINS/TCP no-protocol, EtherNet/IP, PLC Link, or PROFINET	Ethernet TCP no-protocol	
	I/O expansion	Possible by connecting FQ-SDU1_Sensor Data Unit. 11 inputs and 24 outputs	-	
	RS-232C	Possible by connecting FQ-SDU2_Sensor Data Unit. 8 inputs and 7 outputs	-	
Ratings	Power supply voltage	21.6 to 26.4 VDC (including ripple)		
	Current consumption	2.4 A max.		
Environmental immunity	Ambient temperature range	Operating: 0 to 40°C, Storage: -25 to 65°C (with no icing or condensation)	Operating: 0 to 50°C, Storage: -25 to 65°C (with no icing or condensation)	
	Ambient humidity range	Operating and storage: 35% to 85% (with no condensation)		
	Ambient atmosphere	No corrosive gas		
	Vibration resistance (destruction)	10 to 150 Hz, single amplitude: 0.35 mm, X/Y/Z directions 8 min each, 10 times		
	Shock resistance (destruction)	150 m/s <sup>2</sup> 3 times each in 6 direction (up, down, right, left, forward, and backward)		
	Degree of protection	IEC 60529 IP67 (Except when Polarizing Filter Attachment is mounted or connector cap is removed.)		
Materials	Sensor: PBT, PC, SUS, Mounting Bracket: PBT, Polarizing Filter Attachment: PBT, PC Ethernet connector: Oil-resistance vinyl compound, I/O connector: Lead-free heat-resistant PVC			
Weight	Narrow View/Standard View: Approx. 160 g Wide View: Approx. 150 g			
Accessories included with sensor	Mounting Bracket (FQ-XL)(1), Polarizing Filter Attachment (FQ-XF1) (1), Instruction Manual, Quick Startup Guide, Member Registration Sheet, Warning Label			
LED class	Class 2(Applicable standards: IEC 60825-1:1993 +A1:1997 +A2:2001, EN 60825-1:1994 +A1:2002 +A2:2001, and JIS C 6802:2005)			
Applicable standards	EN 61326-1:2006 and IEC61010-1			

## Touch Finder

Item	Type	Model with DC power supply		Model with AC/DC/battery power supply
		Model	FQ2-D30	FQ2-D31
Number of connectable Sensor		Number of sensors that can be recognized (switched): 32 max. number or sensor that can displayed on monitor: 8 max.		
Main functions	Types of measurement displays	Last result display, Last NG display, trend monitor, histograms		
	Types of display images	Through, frozen, zoom-in, and zoom-out images		
	Data logging	Measurement results, measured images		
	Menu language	English, German, French, Italian, Spanish, Traditional Chinese, Simplified Chinese, Korean, Japanese		
Indications	LCD	Display device	3.5-inch TFT color LCD	
		Pixels	320 × 240	
		Display colors	16.7 million	
	Backlight	Life expectancy <sup>*1</sup>	50,000 hours at 25°C	
		Brightness adjustment	Provided	
Screen saver	Provided			
Operation interface	Touch screen	Method	Resistance film	
		Life expectancy <sup>*2</sup>	1,000,000 touch operations	
External interface	Ethernet	100BASE-TX/10BASE-T		
	SD card	SDHC-compliant, Class 4 or higher recommended		
Ratings	Power supply voltage	DC power connection: 21.6 to 26.4 VDC (including ripple)	DC power connection: 21.6 to 26.4 VDC (including ripple) AC adapter (manufactured by Sino-American Japan Co., Ltd) connection: 100 to 240 VAC, 50/60 Hz Battery connection: FQ-BAT1 Battery (1cell, 3.7 V)	
	Continuous operation on Battery <sup>*3</sup>	-	1.5 h	
	Power consumption	DC power connection: 0.2 A max.	DC power connection: 0.2 A max. Charging battery: 0.4 A max.	
Environmental immunity	Ambient temperature range	Operating: 0 to 50°C Storage: -25 to 65°C (with no icing or condensation)	Operating: 0 to 50°C when mounted to DIN Track or panel Operation on Battery: 0 to 40°C:-25 to 65°C (with no icing or condensation)	
	Ambient humidity range	Operating and storage: 35% to 85% (with no condensation)		
	Ambient atmosphere	No corrosive gas		
	Vibration resistance (destruction)	10 to 150 Hz, single amplitude: 0.35 mm, X/Y/Z directions 8 min each, 10 times		
	Shock resistance (destruction)	150 m/s <sup>2</sup> 3 times each in 6 direction (up, down, right, left, forward, and backward)		
Degree of protection	IEC 60529 IP20 (when SD card cover, connector cap, or harness is attached)			

## FQ2

## Inspection systems

Item	Type	Model with DC power supply	Model with AC/DC/battery power supply
	Model	FQ2-D30	FQ2-D31
Weight	Approx. 270 g (without Battery and hand strap attached)		
Materials	Case: ABS		
Accessories included with Touch Finder	Touch Pen (FQ-XT), Instruction Manual		

\*1 This is a guideline for the time required for the brightness to diminish to half the initial brightness at room temperature and humidity. The life of the backlight is greatly affected by the ambient temperature and humidity and will be shorter at lower or higher temperatures.

\*2 This value is only a guideline. No guarantee is implied. The value will be affected by operating conditions.

\*3 This value is only a guideline. No guarantee is implied. The value will be affected by the operating environment and operating conditions.

## Sensor Data Units(FQ2-S3/S4/CH only)

Item	Parallel Interface		RS-232C Interface
Model	NPN	FQ-SDU10	FQ-SDU20
	PNP	FQ-SDU15	FQ-SDU25
I/O specifications	Parallel I/O	Connector 1	6 inputs (IN0 to IN5)
		Connector 2	2 inputs (TRIG and RESET) 7 outputs (ACK, RUN, BUSY, OR, ERROR, STGOUT, and SHTOUT)
	RS-232C		1 channel, 115,200 bps max.
	Sensor interface		FQ2-S3 connected with FQ-WU□□□: OMRON interface *Number of connected Sensors: 1
Ratings	Power supply voltage	21.6 to 26.4 VDC (including ripple)	
	Insulation resistance	Between all DC external terminals and case: 0.5 MΩ min (at 250 VDC)	
	Current consumption	2.5 A max.: FQ2-S□□□□□□□-□□□□ and FQ-SDU□□□ 0.4 A max.: FQ2-S3□□-□□□□ and FQ-SDU□□□ 0.1 A max.: FQ-SDU□□□□ only	
Environmental immunity	Ambient temperature range	Operating: 0 to 50°C, Storage: -20 to 65°C (with no icing or condensation)	
	Ambient humidity range	Operating and storage: 35% to 85% (with no condensation)	
	Ambient atmosphere	No corrosive gas	
	Vibration resistance (destruction)	10 to 150 Hz, single amplitude: 0.35 mm, X/Y/Z directions, 8 min each, 10 times	
	Shock resistance (destruction)	150 m/s <sup>2</sup> 3 times each in 6 directions (up, down, right, left, forward, and backward)	
Degree of protection	IEC 60529 IP20		
Materials	Case: PC + ABS, PC		
Weight	Approx. 150 g		
Accessories included with Sensor Data Unit	Instruction Manual		

## Battery

Item	Model	FQ-BAT1
Battery type	Secondary lithium ion battery	
Nominal capacity	1,800 mAh	
Rated voltage	3.7 V	
Ambient temperature range	Operating: 0 to 40°C Storage: -25 to 65°C (with no icing or condensation)	
Ambient humidity range	Operating and storage: 35% to 85% (with no condensation)	
Charging method	Charged in Touch Finder (FQ2-D31). AC adapter (FQ-AC□) is required.	
Charging time*1	2 h	
Usage time*1	1.5 h	
Battery backup life*2	300 charging cycles	
Weight	50 g max.	

\*1 This value is only a guideline. No guarantee is implied. The value will be affected by operating conditions

\*2 This is a guideline for the time required for the capacity of the Battery to be reduced to 60% of the initial capacity. No guarantee is implied. The value will be affected by the operating environment and operating conditions.

## System Requirements for PC tool for FQ

The following Personal Computer system is required to use the software.

OS	Microsoft Windows XP Home Edition/Professional SP2 or higher (32-bit version) Microsoft Windows 7 Home Premium or higher (32-bit/64-bit version)
CPU	Core 2 Duo 1.06 GHz or the equivalent or higher
RAM	1GB min.
HDD	500 MB min. available space*1
Monitor	1,024 × 768 dots min.

\*1 Available space is also required separately for data logging.

Windows is registered trademarks of Microsoft Corporation in the USA and other countries.  
Other company names and product names in this document are the trademarks or registered trademarks of their respective companies.

# FQ2

# Inspection systems

## Dimensions

(Unit: mm)

### Sensor

#### Integrated Sensor

##### Narrow View

- FQ2-S□□□10F-□□□
- FQ2-CH□□□10F-M
- FQ-CR□□□10F-M

##### Standard View

- FQ2-S□□□50F-□□□
- FQ2-CH□□□50F-M
- FQ-CR□□□50F-M

##### Wide View

- FQ2-S□□□100□-□□□
- FQ2-CH□□□100□-M
- FQ-CR□□□100□-M

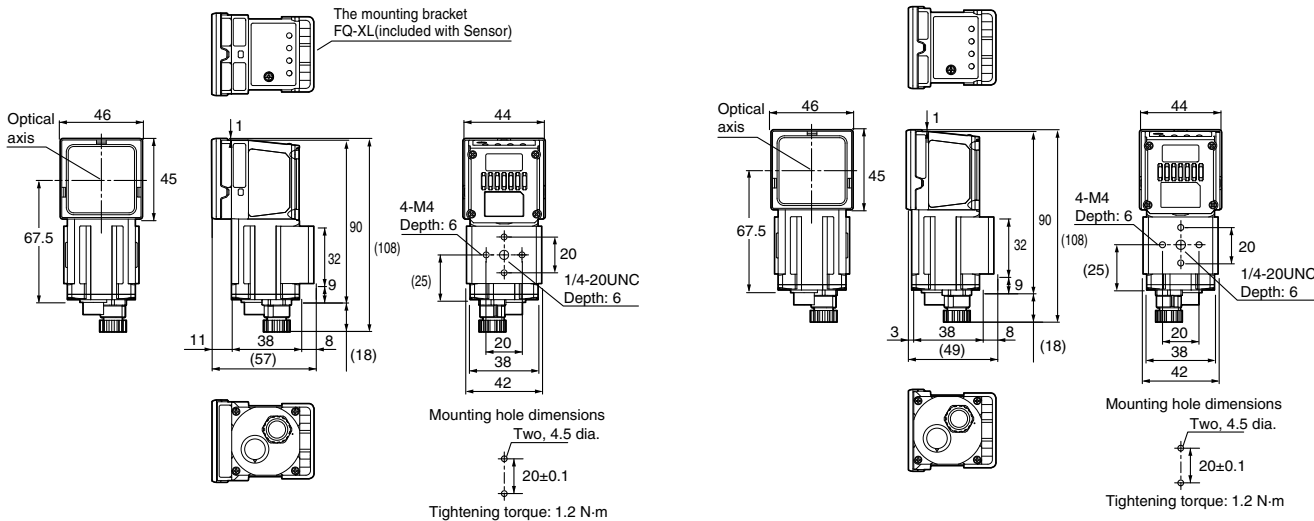

### C-mount

- FQ2-S3□-13□
- FQ2-S4□-13□

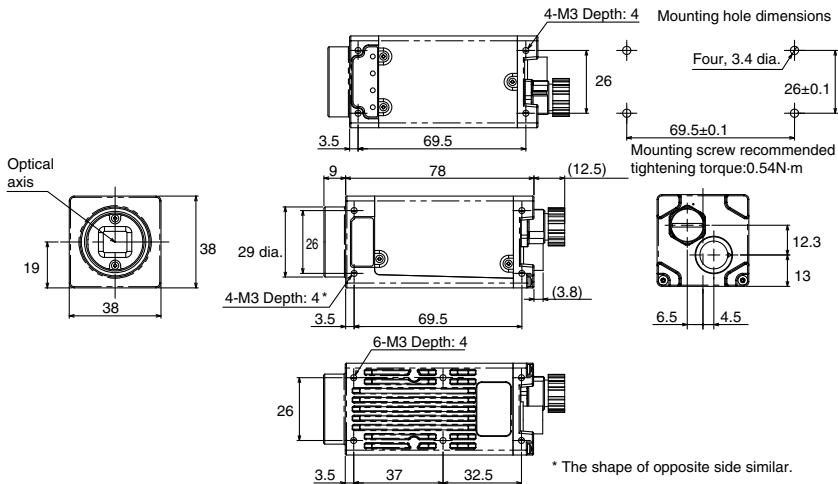

### Mounting Base FQ-XLC (included with Sensor)

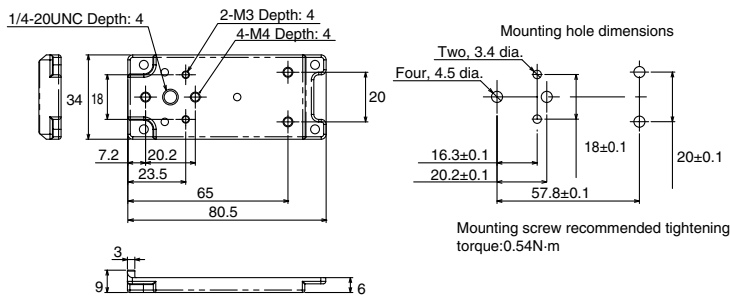

Optical Chart for C-mount Camera FQ2-S3-13/-S4-13

High-resolution, Low-distortion Lenses 3Z4S-LE SV-13-13H

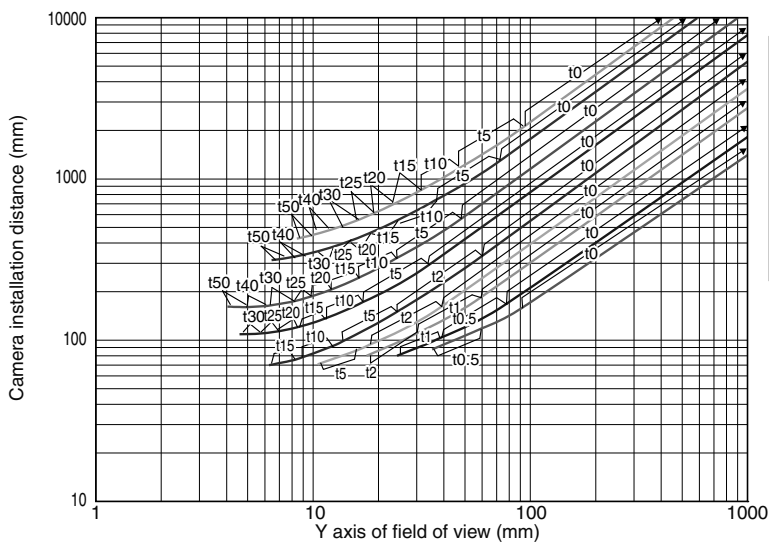

Meaning of Optical Chart

The X axis of the optical chart shows the field of vision (mm) (See Note.), and the Y axis of the optical chart shows the camera installation distance (mm).

Note: The lengths of the fields of vision given in the optical charts are the lengths of the Y axis.

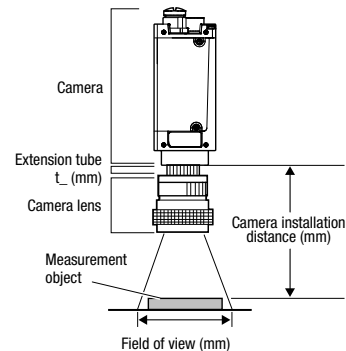

Related Manuals

Man. No.	Model number	Manual
Z337	FQ2-S1/S2/S3/S4/CH	Smart Camera FQ2-S/CH Series User's manual
Z338	FQ2-S1/S2/S3/S4/CH	Smart Camera FQ2-S/CH Series User's manual (Communication Settings)
Z329	FQ-CR1-M	Fixed Mount Multi Code Reader FQ-CR1-M User's manual
Z316	FQ-CR2	Fixed Mount 2D Code Reader FQ-CR2 User's manual



**OMRON EUROPE B.V.** Wegalaan 67-69, NL-2132 JD, Hoofddorp, The Netherlands. Tel: +31 (0) 23 568 13 00 Fax: +31 (0) 23 568 13 88 [www.industrial.omron.eu](http://www.industrial.omron.eu)

**Austria**

Tel: +43 (0) 2236 377 800  
[www.industrial.omron.at](http://www.industrial.omron.at)

**Belgium**

Tel: +32 (0) 2 466 24 80  
[www.industrial.omron.be](http://www.industrial.omron.be)

**Czech Republic**

Tel: +420 234 602 602  
[www.industrial.omron.cz](http://www.industrial.omron.cz)

**Denmark**

Tel: +45 43 44 00 11  
[www.industrial.omron.dk](http://www.industrial.omron.dk)

**Finland**

Tel: +358 (0) 207 464 200  
[www.industrial.omron.fi](http://www.industrial.omron.fi)

**France**

Tel: +33 (0) 1 56 63 70 00  
[www.industrial.omron.fr](http://www.industrial.omron.fr)

**Germany**

Tel: +49 (0) 2173 680 00  
[www.industrial.omron.de](http://www.industrial.omron.de)

**Hungary**

Tel: +36 1 399 30 50  
[www.industrial.omron.hu](http://www.industrial.omron.hu)

**Italy**

Tel: +39 02 326 81  
[www.industrial.omron.it](http://www.industrial.omron.it)

**Netherlands**

Tel: +31 (0) 23 568 11 00  
[www.industrial.omron.nl](http://www.industrial.omron.nl)

**Norway**

Tel: +47 (0) 22 65 75 00  
[www.industrial.omron.no](http://www.industrial.omron.no)

**Poland**

Tel: +48 22 458 66 66  
[www.industrial.omron.pl](http://www.industrial.omron.pl)

**Portugal**

Tel: +351 21 942 94 00  
[www.industrial.omron.pt](http://www.industrial.omron.pt)

**Russia**

Tel: +7 495 648 94 50  
[www.industrial.omron.ru](http://www.industrial.omron.ru)

**South Africa**

Tel: +27 (0)11 579 2600  
[www.industrial.omron.co.za](http://www.industrial.omron.co.za)

**Spain**

Tel: +34 913 777 900  
[www.industrial.omron.es](http://www.industrial.omron.es)

**Sweden**

Tel: +46 (0) 8 632 35 00  
[www.industrial.omron.se](http://www.industrial.omron.se)

**Switzerland**

Tel: +41 (0) 41 748 13 13  
[www.industrial.omron.ch](http://www.industrial.omron.ch)

**Turkey**

Tel: +90 212 467 30 00  
[www.industrial.omron.com.tr](http://www.industrial.omron.com.tr)

**United Kingdom**

Tel: +44 (0) 870 752 08 61  
[www.industrial.omron.co.uk](http://www.industrial.omron.co.uk)

**More Omron representatives**  
[www.industrial.omron.eu](http://www.industrial.omron.eu)

**Automation Systems**

- Programmable logic controllers (PLC) • Human machine interfaces (HMI) • Remote I/O
- Industrial PC's • Software

**Motion & Drives**

- Motion controllers • Servo systems • Inverters

**Control Components**

- Temperature controllers • Power supplies • Timers • Counters • Programmable relays
- Digital panel indicators • Electromechanical relays • Monitoring products • Solid-state relays
- Limit switches • Pushbutton switches • Low voltage switch gear

**Sensing & Safety**

- Photoelectric sensors • Inductive sensors • Capacitive & pressure sensors
- Cable connectors • Displacement & width-measuring sensors • Vision systems
- Safety networks • Safety sensors • Safety units/relay units • Safety door/guard lock switches

Although we strive for perfection, Omron Europe BV and/or its subsidiary and affiliated companies do not warrant or make any representations regarding the correctness or completeness of the information described in this document. We reserve the right to make any changes at any time without prior notice.



# SCATTERGOOD & JOHNSON LTD

ELECTRICAL ENGINEERING & FLUID CONTROL DISTRIBUTORS

Est.1899

At Scattergood & Johnson Ltd, we pride ourselves on being a technical distributor to specialist industries.

Working with a range of quality product suppliers across a number of specialist markets, we are not your average 'box shifter' - we are your technical and supply chain partner.

We fully support every product we sell - for free! Our internal team and external sales engineers can answer any product or application question, no matter the complexity.

Backing up this technical ability is a range of 50,000+ products available from stock for nationwide next day delivery (same day if required!), or you can collect what you need from any of our trade counters around the UK.

Select your specialist interest below to learn more about how we can help.



Online, In Branch and On the Road - Scattergood & Johnson Ltd, there when you need us.

# [www.scatts.co.uk](http://www.scatts.co.uk)