

GX-ILM□, NX-ILM□

IO-Link

IO-Link makes communication down to the sensor level visible

- Machine downtime can be reduced
- Abnormality detection for shortest recovery
- Condition monitoring for predictive maintenance
- Individual identification for reduction of man hours
- Master unit with screw-less terminal block or with IP67 protection class for watery and dusty environments
- Up to 8 sensors can be connected with one IO-Link master unit
- Photoelectric and Proximity sensors



System configuration

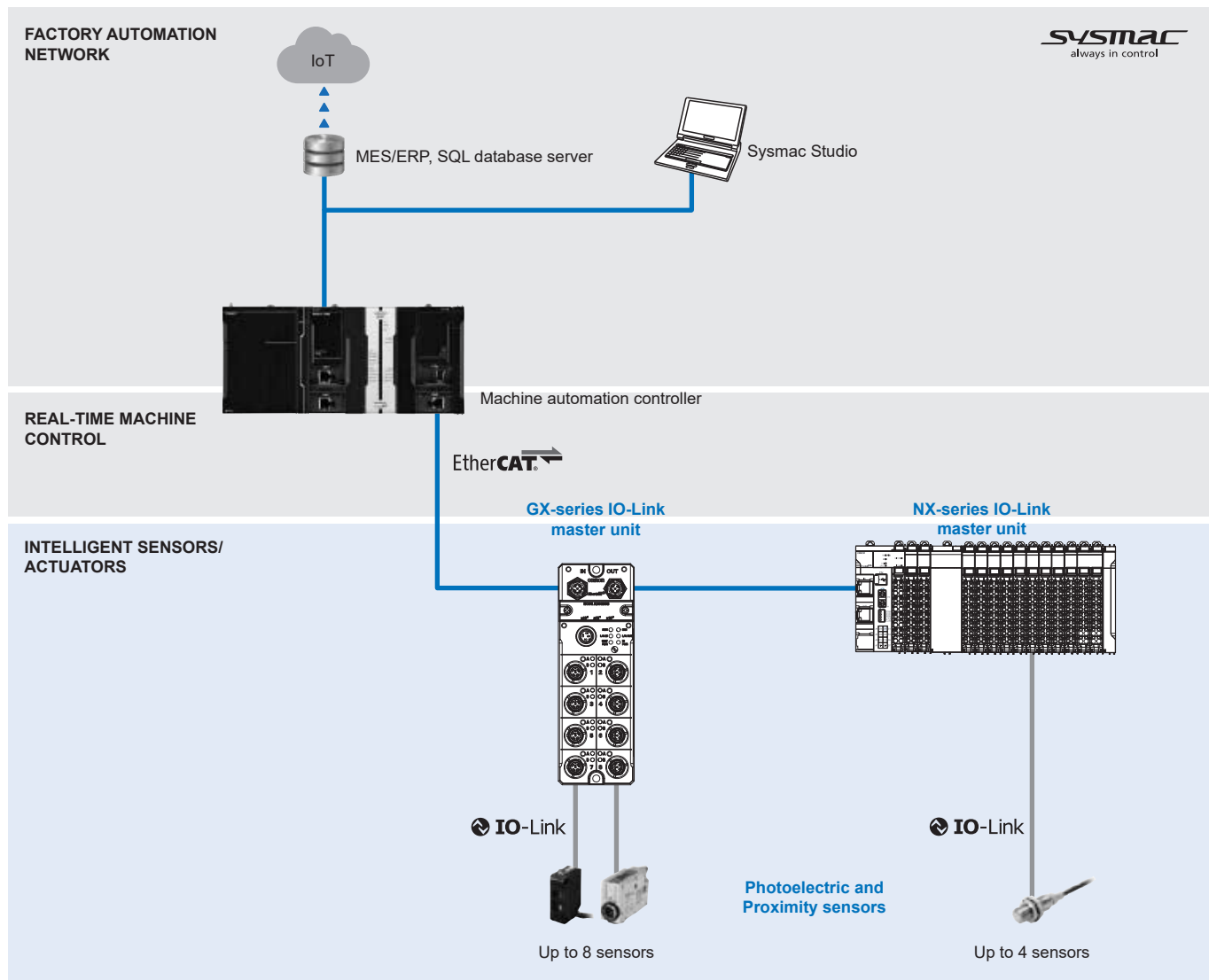

Specifications

NX-series IO-Link master unit

Model		NX-ILM400
Product family		NX-series
Number of ports		4
Communication specifications	Protocol	IO-Link protocol
	Baud rate	COM1: 4.8 kbps / COM2: 38.4 kbps / COM3: 230.4 kbps
	Topology	1:1
	Compliant standards	<ul style="list-style-type: none"> IO-Link Interface and System Specification Version 1.12 IO-Link Test Specification Version 1.12
Power supply to devices in IO-Link mode or SIO (DI) mode	Rated voltage	24 VDC (20.4 to 28.8 VDC)
	Max. load current	0.2 A/port
	Short-circuit protection	Provided
Digital inputs (in SIO (DI) mode)	Internal I/O common	PNP
	Rated voltage	24 VDC (20.4 to 28.8 VDC)
	Input current	5 mA typical (at 24 VDC)
	ON voltage/ON current	15 VDC min, 2 mA min.
	OFF voltage	5 VDC max.
	Input filter time	No filter, 0.25 ms, 0.5 ms, 1 ms (default), 2 ms, 4 ms, 8 ms, 16 ms, 32 ms, 64 ms, 128 ms, 256 ms
Digital outputs (in SIO (DO) mode)	Internal I/O common	PNP
	Output type	Push-pull
	Rated voltage	24 VDC (20.4 to 28.8 VDC)
	Max. load current	0.1 A/port
	Short-circuit protection	Provided
	Leakage current	0.1 mA max.
	Residual voltage	1.5 V max.
Digital inputs for pin 2 (in IO-Link mode)	Internal I/O common	PNP
	Rated voltage	24 VDC (20.4 to 28.8 VDC)
	Input current	2 mA typical (at 24 VDC)
	ON voltage/ON current	15 VDC min, 2 mA min.
	OFF voltage	5 VDC max.
Cable specifications	Input filter time	No filter, 0.25 ms, 0.5 ms, 1 ms (default), 2 ms, 4 ms, 8 ms, 16 ms, 32 ms, 64 ms, 128 ms, 256 ms
	Cable type	Unshielded
	Max. length	20 m
	Electrostatic capacity between lines	3 nF max.
Operating environment	Loop resistance	6 Ω max.
	Ambient operating temperature	0 to 55°C
	Ambient storage temperature	-25 to 70°C (with no condensation or icing)
	Ambient operating/storage humidity	10 to 95% (with no condensation or icing)
	Operating atmosphere	No corrosive gases
	Noise immunity	2 kV on power supply line. Conforms to IEC 61000-4-4
	Overvoltage category	Conforms to JIS B3502 and IEC 61131-2
	EMC immunity level	Zone B
	Vibration resistance	Conforms to IEC 60068-2-6 5 to 8.4 Hz with amplitude of 3.5 mm, 8.4 to 150 Hz, acceleration of 9.8 m/s ² 100 min each in X, Y and Z directions (10 sweeps of 10 min each = 100 min total)
	Shock resistance	Conforms to IEC 60028-2-27 147 m/s ² , 3 times each in X, Y and Z directions
Degree of protection	IP20	
Pollution degree	2 or less: Conforms to JIS B3502 and IEC 61131-2	
Dielectric strength	510 VAC between isolated circuits for 1 minute at a leakage current of 5 mA max.	
Insulation resistance	20 MΩ min. between isolated circuits (at 100 VDC)	
Isolation method	Photocoupler isolation	
Unit power consumption	0.80 W	
I/O power supply method	Supply from the NX bus	
I/O current consumption	50 mA	
I/O refreshing method	Free-run refreshing	
Terminal block type	Screwless push-in terminal 16 terminals (A + B)	
Dimensions (W × H × D)	12 × 100 × 71 mm	
Weight	67 g	
Applicable standards	UL 61010-2-201, ANSI/ISA 12.12.01, EU: EN 61131-2, RCM, KC and IO-Link conformance	
Protective function	Load short-circuit protection	

GX-series IO-Link master unit

Model		GX-ILM08C
Product family		GX-series
Number of ports		8
Communication specifications	Protocol	IO-Link protocol
	Baud rate	COM1: 4.8 kbps / COM2: 38.4 kbps / COM3: 230.4 kbps
	Topology	1:1
	Compliant standards	<ul style="list-style-type: none"> • IO-Link Interface and System Specification Version 1.12 • IO-Link Test Specification Version 1.12
Power supply to devices in IO-Link mode or SIO (DI) mode	Rated voltage	24 VDC (20.4 to 26.4 VDC)
	Max. load current	0.2 A/port
	Short-circuit protection	Provided
Digital inputs (in SIO (DI) mode)	Internal I/O common	PNP
	Rated voltage	24 VDC (20.4 to 26.4 VDC)
	Input current	5 mA typical (at 24 VDC)
	ON voltage/ON current	15 VDC min, 5 mA min.
	OFF voltage	5 VDC max.
	Input filter time	No filter, 0.25 ms, 0.5 ms, 1 ms (default), 2 ms, 4 ms, 8 ms, 16 ms, 32 ms, 64 ms, 128 ms, 256 ms
Digital outputs (in SIO (DO) mode)	Internal I/O common	PNP
	Output type	Push-pull
	Rated voltage	24 VDC (20.4 to 26.4 VDC)
	Max. load current	0.3 A/port
	Short-circuit protection	Provided
	Leakage current	0.1 mA max.
	Residual voltage	1.5 V max.
Digital inputs for pin 2 (in IO-Link mode)	Internal I/O common	PNP
	Rated voltage	24 VDC (20.4 to 26.4 VDC)
	Input current	2 mA typical (at 24 VDC)
	ON voltage/ON current	15 VDC min, 2 mA min.
	OFF voltage	5 VDC max.
	Input filter time	No filter, 0.25 ms, 0.5 ms, 1 ms (default), 2 ms, 4 ms, 8 ms, 16 ms, 32 ms, 64 ms, 128 ms, 256 ms
Cable specifications	Cable type	Unshielded
	Max. length	20 m
	Electrostatic capacity between lines	3 nF max.
	Loop resistance	6 Ω max.
Operating environment	Ambient operating temperature	-10 to 55°C
	Ambient storage temperature	-25 to 65°C
	Ambient operating/storage humidity	25 to 85% (with no condensation)
	Operating atmosphere	No corrosive gases
	Noise immunity	2 kV on power supply line. Conforms to IEC 61000-4-4
	Vibration resistance	Malfunction: 10 to 60 Hz with amplitude of 0.7 mm, 60 to 150 Hz and 50 m/s ² for 80 min each in X, Y and Z directions
	Shock resistance	150 m/s ² with amplitude of 0.7 mm
Degree of protection	IP67	
Dielectric strength		600 VAC between isolated circuits
Insulation resistance		20 MΩ min. between isolated circuits
Isolation method		Photocoupler isolation
Unit power consumption		60 mA
I/O power supply method		Supplied from the power supply connector
I/O current consumption		100 mA
Mounting		M5 screw mounting
Mounting strength		100 N
Communications connector strength		30 N
Connectors		EtherCAT communications connectors: M12 (D-coding, female) × 2 Power supply connector: M12 (A-coding, male) × 1 I/O connectors: M12 (A-coding, female) × 8 ¹
Screw tightening torque²		Round connectors (communications connector, power supply and I/O): 0.39 to 0.49 N·m M5 (unit mounted from the front): 1.47 to 1.96 N·m Cover for node address setting switches: 0.4 to 0.6 N·m
Dimensions (W × H × D)		175 × 33 × 60 mm ³
Weight		430 g
Applicable standards		EU: EN 61131-2, RCM, KC, IO-Link conformance and EtherCAT conformance
Protective function		Load short-circuit protection

¹ Confirms to Class A when used as an IO-Link connector.² For Smartclick connectors, insert the connector all the way and turn it approx. 1/8 of a turn. Torque management is not required.³ The height is 49.1 mm when the connectors are included.

Circuit layout

NX-ILM400

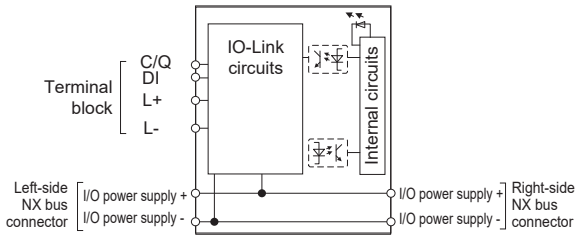

Terminal wiring

NX-ILM400

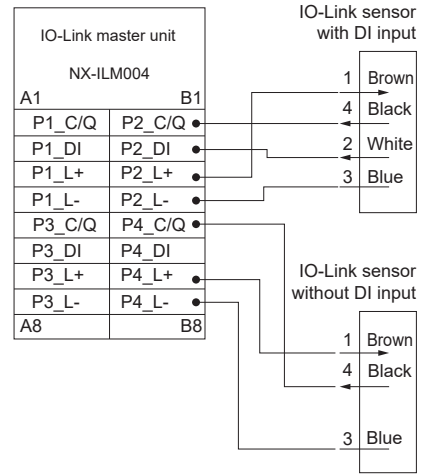

GX-ILM08C

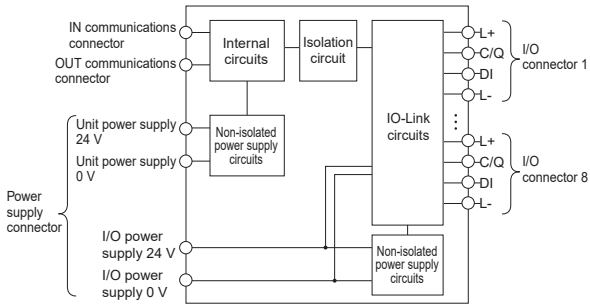

Nomenclature/Dimensions

NX-ILM400

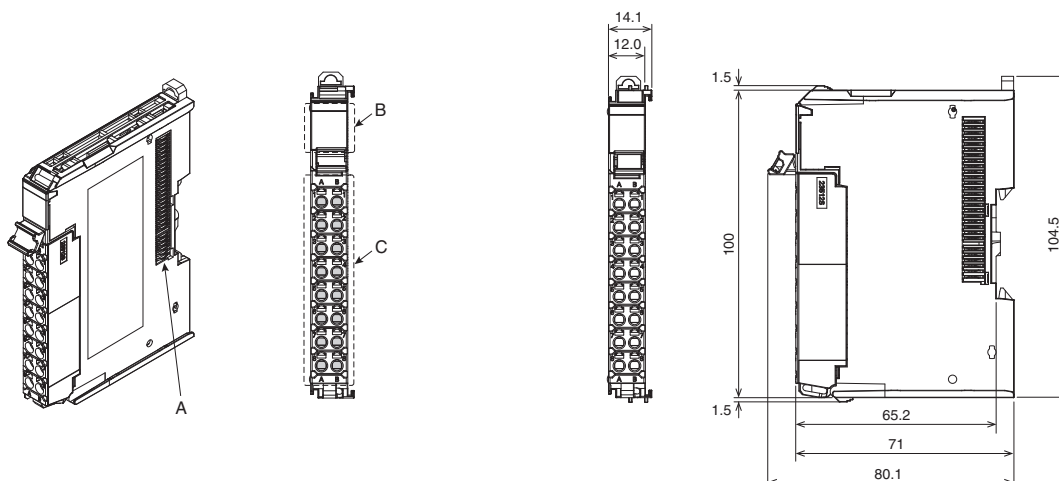

Symbol	Name	Description
A	NX bus connector	This connector is used to connect each unit.
B	Indicators	The indicators show the current operating status of the unit.
C	Terminal block	The terminal block is used to connect external devices. The number of terminals depends on the type of unit.

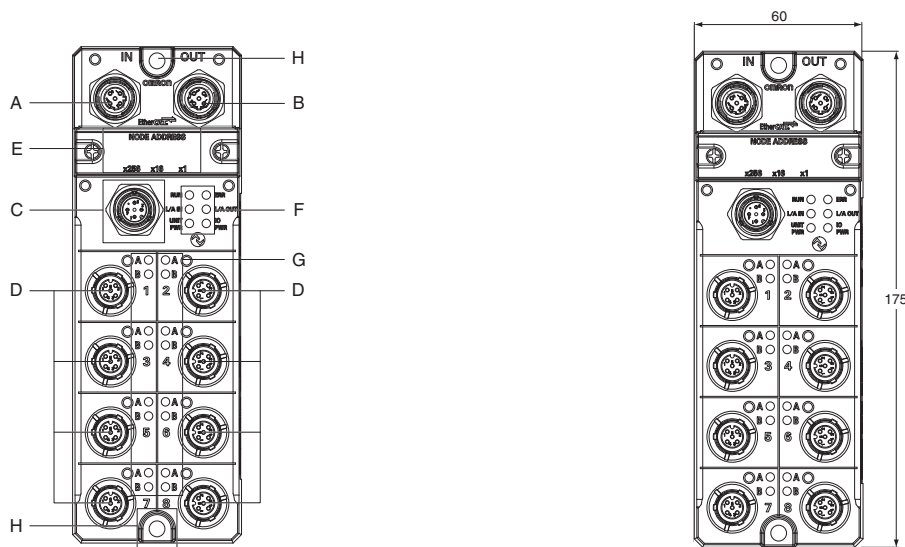

GX-ILM08C



Symbol	Name	Description
A	EtherCAT communications connector, IN	EtherCAT cable connection: IN side M12 connector (D-coding, female)
B	EtherCAT communications connector, OUT	EtherCAT cable connection: OUT side M12 connector (D-coding, female)
C	Power supply connector	Connects to power supply unit and I/O power supply cable M12 connector (A-coding, male)
D	I/O connectors	Connect to IO-Link sensor cables (IO-Link connector type: Class A) M12 connectors (A-coding, female)
E	Node address setting switches	Used to set the EtherCAT node address.
F	Status indicators	Indicate the current status of the EtherCAT slave unit. (RUN, ERR, L/A IN, L/A OUT, UNIT PWR and I/O PWR)
G	I/O indicators	Indicate the I/O status (C/E and C/Q).
H	Mounting holes	Used to mount the unit with M5 screws.







Ordering information

IO-Link master unit

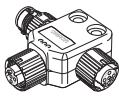

Item	IO-Link ports	Connection type	Degree of protection	Model	Appearance
NX-series IO-Link master unit ^{*1}	4	Screwless push-in (NX-TBA162)	IP20	NX-ILM400	
GX-series IO-Link master unit	8	M12 Smartclick connector	IP67	GX-ILM08C	

*1 EtherCAT communication coupler unit NX-ECC2□□ is necessary for the system configuration.

Accessories

Applicable models	Item	Specifications	Model	
NX-ILM400	Terminal block coding pins	Pins for 10 units (terminal block: 30 pins, unit: 30 pins)	NX-AUX02	
	Terminal block (replacement front connector)	16 wiring terminals (A + B)	NX-TBA162	
	End cover	Included with communication coupler	NX-END01	
GX-ILM08C	Power supply T-joint connector	Connector used when branching a GX-series IO-Link master unit power supply. 	XS5R-D427-5	
	Waterproof cover for M12 connectors (female). When you use this waterproof cover, you can maintain the IP67 protective structure. Can be mounted on an EtherCAT connector or I/O connector	M12 threaded waterproof cover, Screw-type connector, material: brass/nickel plated 	XS2Z-22	
		M12 Smartclick waterproof cover, Smartclick connector, material: PBT 	XS5Z-11	
	Torque wrench	Tool for tightening M12 threaded connectors 	XY2F-0004	
	EtherCAT communication cables (Cable with connectors on both ends, Rugged type, Shield strengthening cable, AWG22, 2-pair cable, Color: Black, Manufacturer: OMRON)	Smartclick connector M12 straight/M12 straight 	0.5 m	XS5W-T421-BM2-SS
1 m			XS5W-T421-CM2-SS	
2 m			XS5W-T421-DM2-SS	
3 m			XS5W-T421-EM2-SS	
5 m			XS5W-T421-GM2-SS	
10 m			XS5W-T421-JM2-SS	
Smartclick connector M12 straight/RJ45 straight 		0.5 m	XS5W-T421-BMC-SS	
		1 m	XS5W-T421-CMC-SS	
		2 m	XS5W-T421-DMC-SS	
		3 m	XS5W-T421-EMC-SS	
		5 m	XS5W-T421-GMC-SS	
		10 m	XS5W-T421-JMC-SS	
Power cables (Socket on one cable side) 		Smartclick connector M12 straight	1 m	XS5F-D421-C80-F
			2 m	XS5F-D421-D80-F
		3 m	XS5F-D421-E80-F	
		5 m	XS5F-D421-G80-F	
		10 m	XS5F-D421-J80-F	

Photoelectric sensor

Sensing method		Sensing distance	Connection method	Baud rate	Model (PNP)	Appearance
Through-beam (emitter + receiver) ^{*1}		15 m	Pre-wired (2 m)	COM2	E3Z-T81-IL2 2M	
			Pre-wired M12 connector		E3Z-T81-M1TJ-IL2 0.3M	
			Standard M8 connector		E3Z-T86-IL2	
			Pre-wired (2 m)	COM3	E3Z-T81-IL3 2M	
			Pre-wired M12 connector		E3Z-T81-M1TJ-IL3 0.3M	
			Standard M8 connector		E3Z-T86-IL3	
Retro-reflective with MSR function ^{*2}		4 m ^{*3}	Pre-wired (2 m)	COM2	E3Z-R81-IL2 2M	
			Pre-wired M12 connector		E3Z-R81-M1TJ-IL2 0.3M	
			Standard M8 connector		E3Z-R86-IL2	
			Pre-wired (2 m)	COM3	E3Z-R81-IL3 2M	
			Pre-wired M12 connector		E3Z-R81-M1TJ-IL3 0.3M	
			Standard M8 connector		E3Z-R86-IL3	
Diffusive-reflective		1 m	Pre-wired (2 m)	COM2	E3Z-D82-IL2 2M	
			Pre-wired M12 connector		E3Z-D82-M1TJ-IL2 0.3M	
			Standard M8 connector		E3Z-D87-IL2	
			Pre-wired (2 m)	COM3	E3Z-D82-IL3 2M	
			Pre-wired M12 connector		E3Z-D82-M1TJ-IL3 0.3M	
			Standard M8 connector		E3Z-D87-IL3	
	90 mm (narrow beam)			Pre-wired (2 m)	COM2	E3Z-L81-IL2 2M
				Pre-wired M12 connector		E3Z-L81-M1TJ-IL2 0.3M
				Standard M8 connector		E3Z-L86-IL2
				Pre-wired (2 m)	COM3	E3Z-L81-IL3 2M
				Pre-wired M12 connector		E3Z-L81-M1TJ-IL3 0.3M
				Standard M8 connector		E3Z-L86-IL3

*1 Through-beam sensors are normally sold in sets that include both the emitter and receiver. Refer to "IO-Link catalogue (Y212-E1)" for separate items.

*2 The reflector is sold separately. Select the reflector model most suited to the application.

*3 The sensing distance specified is possible when the E39-R1S is used. The minimum required distance between the sensor and reflector is 100 mm.

Slit (Not provided with through-beam sensors. Order a slit separately if required)

Slit width	Sensing distance E3Z-T□□	Min. detectable object (reference value)	Model ^{*1}
0.5 mm dia.	50 mm	0.2 mm dia.	E39-S65A
1 mm dia.	200 mm	0.4 mm dia.	E39-S65B
2 mm dia.	800 mm	0.7 mm dia.	E39-S65C
0.5 × 10 mm	1 m	0.2 mm dia.	E39-S65D
1 × 10 mm	2.2 m	0.5 mm dia.	E39-S65E
2 × 10 mm	5 m	0.8 mm dia.	E39-S65F









*1 One set contains slits for emitter and receiver.

Reflector (Required for retro-reflective sensors. Not provided with the sensor. Order a reflector separately)

Item	Sensing distance E3Z-R□□ ^{*1}		Model
	Rated value	Reference value	
Reflector	3 m (100 mm)	–	E39-R1
	4 m (100 mm)	–	E39-R1S
	–	5 m (100 mm)	E39-R2
	–	2.5 m (100 mm)	E39-R9
	–	3.5 m (100 mm)	E39-R10
Fog preventive coating	–	3 m (100 mm)	E39-R1K
Small reflector	–	1.5 m (50 mm)	E39-R3
Reflector tape	–	700 mm (150 mm)	E39-RS1
	–	1.1 m (150 mm)	E39-RS2
	–	1.4 m (150 mm)	E39-RS3

*1 Values in the parentheses indicate the minimum required distance between the sensor and reflector.

Mounting brackets (Not provided with sensors. Order a mounting bracket separately if required)

Item	Material	Model	Appearance
Mounting brackets	SUS304	E39-L153 ^{*1}	
		E39-L104 ^{*1}	
Horizontal mounting brackets		E39-L43 ^{*2}	
Horizontal protective cover bracket		E39-L142 ^{*2}	
Rear mounting bracket		E39-L44	
Metal protective cover bracket		E39-L98 ^{*2}	
Sensor adjuster (for left to right adjustment)		E39-L150	
Easily mounted to the aluminum frame rails of conveyors and easily adjusted.		E39-L151	
		Compact protective cover bracket (for E3Z only)	E39-L144 ^{*2}

^{*1} Cannot be used for standard connector models with mounting surface on the bottom. In that case, use pre-wired connector models.

^{*2} Cannot be used for standard connector models.

Sensor I/O connectors for photoelectric sensors (Models with connectors and pre-wired connectors: A connector is not provided with the sensor. Order a connector separately)



Size	Type	Appearance	Cable length	Model
M12	Socket on one cable side	Smartclick connector Straight ^{*1}	2 m	XS5F-D421-D80-F
			5 m	XS5F-D421-G80-F
	Socket and plug on cable ends ^{*3}	Smartclick connector L-shape ^{*1*2}	2 m	XS5F-D422-D80-F
			5 m	XS5F-D422-G80-F
		Smartclick connector Straight/Straight ^{*1}	2 m	XS5W-D421-D81-F
			5 m	XS5W-D421-G81-F
			5 m	XS5W-D422-G81-F
M8	Socket on one cable side	Straight ^{*1}	2 m	XS3F-M421-402-A
			5 m	XS3F-M421-405-A
	L-shape ^{*1*2}	2 m	XS3F-M422-402-A	
		5 m	XS3F-M422-405-A	
M8 socket/M12 plug	Socket and plug on cable ends	Smartclick connector M8-M12 conversion cable ^{*1}	0.2 m	XS3W-M42C-4C2-A

^{*1} The connectors will not rotate after they are connected.

^{*2} The cable is fixed at an angle of 180° from the sensor emitter/receiver surface.

^{*3} Straight type/L-shape type combinations are also available.

Color mark photoelectric sensor

Sensing method	Sensing distance	Connection method	Output	Baud rate	Model	Appearance
Diffusive-reflective (mark detection)	 10 ±3 mm	M12 connector	Push-pull	COM2	E3S-DCP21-IL2	
				COM3	E3S-DCP21-IL3	

Sensor I/O connectors for color mark photoelectric sensor (Required for a sensor with a connector. Connectors are not provided with the sensors. Order a connector separately)



Size	Type	Appearance	Cable length	Model
M12	Socket on one cable side	Straight ^{*1}	2 m	XS2F-D421-D80-F
			5 m	XS2F-D421-G80-F
		L-shape ^{*1*2}	2 m	XS2F-D422-D80-F
			5 m	XS2F-D422-G80-F
	Socket and plug on cable ends ^{*3}	Smartclick connector Straight/Straight ^{*1}	2 m	XS5W-D421-D81-F
			5 m	XS5W-D421-G81-F
		Smartclick connector L-shape/L-shape ^{*1*2}	2 m	XS5W-D422-D81-F
			5 m	XS5W-D422-G81-F

^{*1} The connectors will not rotate after they are connected.



^{*2} The cable is fixed at an angle of 180° from the sensor emitter/receiver surface.

^{*3} Straight type/L-shape type combinations are also available.

Standard proximity sensor (DC 3-wire)

Size	Sensing distance	Connection method	Cable material	Operating mode	Baud rate	Model (PNP)	Appearance	
Shielded 	M12	Pre-wired models (2 m)	PVC (oil-resistant)	NO/NC switching	COM2	E2E-X3B4-IL2 2M		
						COM3		E2E-X3B4-IL3 2M
		M12 pre-wired Smartclick connector models (0.3 m)				COM2		E2E-X3B4-M1TJ-IL2 0.3M
						COM3		E2E-X3B4-M1TJ-IL3 0.3M
	M18	Pre-wired models (2 m)				COM2		E2E-X7B4-IL2 2M
						COM3		E2E-X7B4-IL3 2M
		M12 pre-wired Smartclick connector models (0.3 m)				COM2		E2E-X7B4-M1TJ-IL2 0.3M
						COM3		E2E-X7B4-M1TJ-IL3 0.3M
	M30	Pre-wired models (2 m)				COM2		E2E-X10B4-IL2 2M
						COM3		E2E-X10B4-IL3 2M
		M12 pre-wired Smartclick connector models (0.3 m)				COM2		E2E-X10B4-M1TJ-IL2 0.3M
						COM3		E2E-X10B4-M1TJ-IL3 0.3M

Spatter-resistant proximity sensor (DC 3-wire)

Size	Sensing distance	Connection method	Cable material	Operating mode	Baud rate	Model	Appearance	
Shielded 	M12	Pre-wired models (2 m)	PVC	NO/NC switching	COM2	E2EQ-X3B4-IL2 2M		
						COM3		E2EQ-X3B4-IL3 2M
		M12 pre-wired Smartclick connector models (0.3 m)				COM2		E2EQ-X3B4-M1TJ-IL2 0.3M
						COM3		E2EQ-X3B4-M1TJ-IL3 0.3M
	M18	Pre-wired models (2 m)				COM2		E2EQ-X7B4-IL2 2M
						COM3		E2EQ-X7B4-IL3 2M
		M12 pre-wired Smartclick connector models (0.3 m)				COM2		E2EQ-X7B4-M1TJ-IL2 0.3M
						COM3		E2EQ-X7B4-M1TJ-IL3 0.3M
	M30	Pre-wired models (2 m)				COM2		E2EQ-X10B4-IL2 2M
						COM3		E2EQ-X10B4-IL3 2M
		M12 pre-wired Smartclick connector models (0.3 m)				COM2		E2EQ-X10B4-M1TJ-IL2 0.3M
						COM3		E2EQ-X10B4-M1TJ-IL3 0.3M

Sensor I/O connectors for standard and spatter-resistant proximity sensors (Models with pre-wired connectors: A connector is not provided with the sensor. Order a connector separately)

Size	Type	Appearance	Cable length	Model
M12	Socket on one cable side	Smartclick connector Straight ^{*1}	2 m	XS5F-D421-D80-F
			5 m	XS5F-D421-G80-F
		Smartclick connector L-shape ^{*1*2}	2 m	XS5F-D422-D80-F
			5 m	XS5F-D422-G80-F
	Socket and plug on cable ends ^{*3}	Smartclick connector Straight/Straight ^{*1}	2 m	XS5W-D421-D81-F
			5 m	XS5W-D421-G81-F
		Smartclick connector L-shape/L-shape ^{*1*2}	2 m	XS5W-D422-D81-F
			5 m	XS5W-D422-G81-F

^{*1} The connectors will not rotate after they are connected.

^{*2} The cable is fixed at an angle of 180° from the sensor emitter/receiver surface.

^{*3} Straight type/L-shape type combinations are also available.

Computer software

Item	Model
Sysmac Studio version 1.16 or higher	SYSMAC-SE2□□□

ALL DIMENSIONS SHOWN ARE IN MILLIMETERS.

To convert millimeters into inches, multiply by 0.03937. To convert grams into ounces, multiply by 0.03527.

Cat. No. SysCat_I191E-EN-01A In the interest of product improvement, specifications are subject to change without notice.



SCATTERGOOD & JOHNSON LTD

ELECTRICAL ENGINEERING & FLUID CONTROL DISTRIBUTORS

Est.1899

At Scattergood & Johnson Ltd, we pride ourselves on being a technical distributor to specialist industries.

Working with a range of quality product suppliers across a number of specialist markets, we are not your average 'box shifter' - we are your technical and supply chain partner.

We fully support every product we sell - for free! Our internal team and external sales engineers can answer any product or application question, no matter the complexity.

Backing up this technical ability is a range of 50,000+ products available from stock for nationwide next day delivery (same day if required!), or you can collect what you need from any of our trade counters around the UK.

Select your specialist interest below to learn more about how we can help.



Online, In Branch and On the Road - Scattergood & Johnson Ltd, there when you need us.

www.scatts.co.uk