

BI3U-M12-AP6X

Inductive sensor

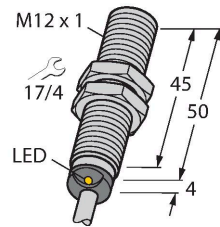

Features

- M12 × 1 threaded barrel
- Chrome-plated brass
- Factor 1 for all metals
- Protection class IP68
- Resistant to magnetic fields
- Extended temperature range
- High switching frequency
- DC 3-wire, 10...30 VDC
- NO contact, PNP output
- Cable connection

Wiring diagram

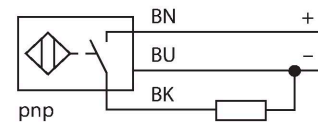

Functional principle

Inductive sensors detect metal objects contactless and wear-free. *uprox*® Factor 1 sensors have significant advantages due to their patented ferrite-coreless multicoil system. They detect all metals at the same large switching distance and are resistant to magnetic fields.

Technical data

Type	BI3U-M12-AP6X
Ident. no.	1634100
Rated switching distance	3 mm
Mounting conditions	Flush
Secured operating distance	$\leq (0.81 \times S_n)$ mm
Repeat accuracy	$\leq 2\%$ of full scale
Temperature drift	$\leq \pm 10\%$
	$\leq \pm 15\%$, $\leq -25\text{ °C}$ v $\geq +70\text{ °C}$
Hysteresis	3...15 %
Ambient temperature	-30...+85 °C
Operating voltage	10...30 VDC
Residual ripple	$\leq 10\% U_s$
DC rated operational current	≤ 200 mA
No-load current	≤ 20 mA
Residual current	≤ 0.1 mA
Isolation test voltage	≤ 0.5 kV
Short-circuit protection	yes / Cyclic
Voltage drop at I_e	≤ 1.8 V
Wire breakage/Reverse polarity protection	yes / Complete
Output function	3-wire, NO contact, PNP
Insulation class	□
Switching frequency	2 kHz
Design	Threaded barrel, M12 × 1
Dimensions	54 mm

Technical data

Housing material	Metal, CuZn, Chrome-plated
Active area material	Plastic, LCP
End cap	Plastic, EPTR
Max. tightening torque housing nut	10 Nm
Electrical connection	Cable
Cable quality	Ø 5.2 mm, LifYY, PVC, 2 m
Core cross-section	3 x 0.34 mm ²
Vibration resistance	55 Hz (1 mm)
Shock resistance	30 g (11 ms)
Protection class	IP68
MTTF	874 years acc. to SN 29500 (Ed. 99) 40 °C
Switching state	LED, Yellow

Mounting instructions

Mounting instructions/Description

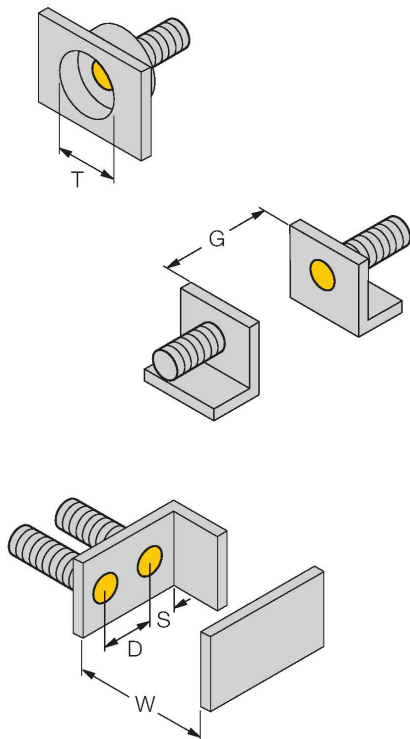

Distance D	24 mm
------------	-------

Distance W	3 x Sn
------------	--------

Distance T	3 x B
------------	-------

Distance S	1.5 x B
------------	---------

Distance G	6 x Sn
------------	--------

Diameter active area B	Ø 12 mm
------------------------	---------

Accessories

QM-12

6945101

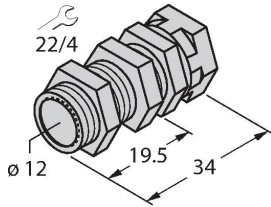

Quick-mount bracket with dead-stop; material: Chrome-plated brass. Male thread M16 × 1. Note: The switching distance of the proximity switches may change when using quick-mount brackets.

BST-12B

6947212

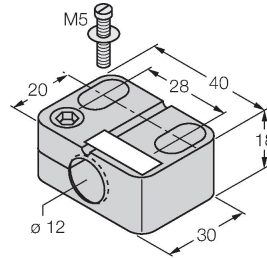

Mounting clamp for threaded barrel sensors, with dead-stop; material: PA6

MW12

6945003

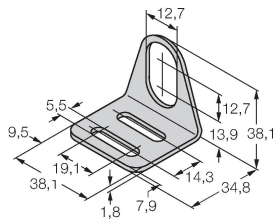

Mounting bracket for threaded barrel sensors; material: Stainless steel A2 1.4301 (AISI 304)

BSS-12

6901321

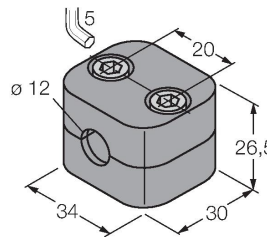

Mounting clamp for smooth and threaded barrel sensors; material: Polypropylene



SCATTERGOOD & JOHNSON LTD

ELECTRICAL ENGINEERING & FLUID CONTROL DISTRIBUTORS

Est.1899

At Scattergood & Johnson Ltd, we pride ourselves on being a technical distributor to specialist industries.

Working with a range of quality product suppliers across a number of specialist markets, we are not your average 'box shifter' - we are your technical and supply chain partner.

We fully support every product we sell - for free! Our internal team and external sales engineers can answer any product or application question, no matter the complexity.

Backing up this technical ability is a range of 50,000+ products available from stock for nationwide next day delivery (same day if required!), or you can collect what you need from any of our trade counters around the UK.

Select your specialist interest below to learn more about how we can help.



Online, In Branch and On the Road - Scattergood & Johnson Ltd, there when you need us.

www.scatts.co.uk