

# BI10-S30-AP6X

## Inductive sensor

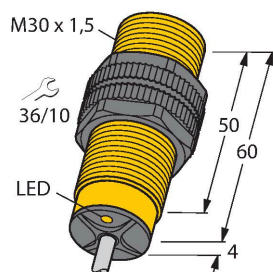

### Features

- Threaded barrel, M30 x 1.5
- Plastic, PA12-GF30
- DC 3-wire, 10...30 VDC
- NO contact, PNP output
- Cable connection

### Wiring diagram

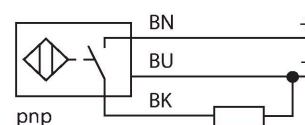

### Functional principle

Inductive sensors detect metal objects contactless and wear-free. For this, they use a high-frequency electromagnetic AC field that interacts with the target. Inductive sensors generate this field via an RLC circuit with a ferrite coil.

### Technical data

Type	BI10-S30-AP6X
Ident. no.	46590
Rated switching distance	10 mm
Mounting conditions	Flush
Secured operating distance	$\leq (0.81 \times S_n)$ mm
Correction factors	St37 = 1; Al = 0.3; stainless steel = 0.7; Ms = 0.4
Repeat accuracy	$\leq 2$ % of full scale
Temperature drift	$\leq \pm 10$ %
Hysteresis	3...15 %
Ambient temperature	-25...+70 °C
Operating voltage	10...30 VDC
Residual ripple	$\leq 10$ % $U_{ss}$
DC rated operational current	$\leq 200$ mA
No-load current	$\leq 15$ mA
Residual current	$\leq 0.1$ mA
Isolation test voltage	$\leq 0.5$ kV
Short-circuit protection	yes / Cyclic
Voltage drop at $I_e$	$\leq 1.8$ V
Wire breakage/Reverse polarity protection	yes / Complete
Output function	3-wire, NO contact, PNP
Switching frequency	0.5 kHz
<b>Design</b>	<b>Threaded barrel, M30 x 1.5</b>
Dimensions	64 mm
Housing material	Plastic, PA12-GF30
Active area material	Plastic, PA12-GF30
End cap	Plastic, EPTR
Max. tightening torque housing nut	5 Nm

## Technical data

Electrical connection	Cable
Cable quality	Ø 5.2 mm, LifYY, PVC, 2 m
Core cross-section	3 x 0.34 mm <sup>2</sup>
Vibration resistance	55 Hz (1 mm)
Shock resistance	30 g (11 ms)
Protection class	IP67
MTTF	2283 years acc. to SN 29500 (Ed. 99) 40 °C
Switching state	LED, Yellow

## Mounting instructions

### Mounting instructions/Description

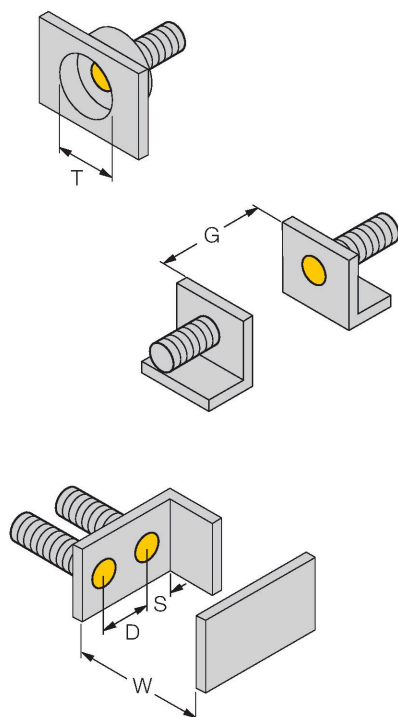

Distance D	2 x B
Distance W	3 x Sn
Distance T	3 x B
Distance S	1.5 x B
Distance G	6 x Sn
Diameter active area B	Ø 30 mm

## Accessories

### QM-30

6945103

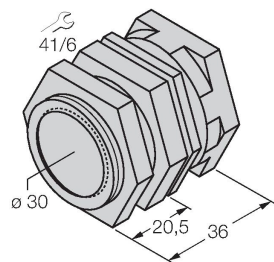

Quick-mount bracket with dead-stop; material: Chrome-plated brass. Male thread M36 x 1.5. Note: The switching distance of the proximity switches may change when using quick-mount brackets.

### BST-30B

6947216

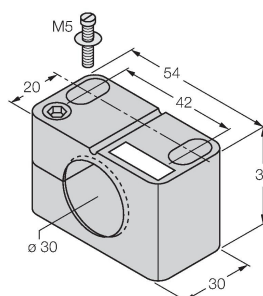

Mounting clamp for threaded barrel sensors, with dead-stop; material: PA6

**MW30**

**6945005**

Mounting bracket for threaded barrel sensors; material: Stainless steel A2 1.4301 (AISI 304)

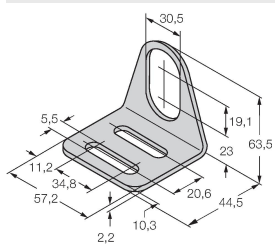

**BSS-30**

**6901319**

Mounting clamp for smooth and threaded barrel sensors; material: Polypropylene

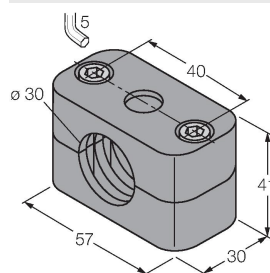



**SCATTERGOOD  
& JOHNSON LTD**  
ELECTRICAL ENGINEERING & FLUID CONTROL DISTRIBUTORS

Est.1899

At Scattergood & Johnson Ltd, we pride ourselves on being a technical distributor to specialist industries.

Working with a range of quality product suppliers across a number of specialist markets, we are not your average 'box shifter' - we are your technical and supply chain partner.

We fully support every product we sell - for free! Our internal team and external sales engineers can answer any product or application question, no matter the complexity.

Backing up this technical ability is a range of 50,000+ products available from stock for nationwide next day delivery (same day if required!), or you can collect what you need from any of our trade counters around the UK.

Select your specialist interest below to learn more about how we can help.



Online, In Branch and On the Road - Scattergood & Johnson Ltd, there when you need us.

**[www.scatts.co.uk](http://www.scatts.co.uk)**